

# CATALOGUE **SHOWERS**

SLIDING SHOWERS	Page 18
HINGED SHOWERS	Page 156
ACCESSORIES FOR SHOWER WALLS	Page 356

# SLIDING SHOWERS





**GOCCIA 35**  
Page 20



**GOCCIA 35 ACCESSORIES**  
Page 44



**GOCCIA 50**  
Page 54



**GOCCIA 50 ACCESSORIES**  
Page 82



**GLMFLAT**  
Page 92



**GLMFLAT ACCESSORIES**  
Page 110



**DCCFLAT**  
Page 120



**DCCFLAT ACCESSORIES**  
Page 134



**GIUMAX**  
Page 140



**GIUMAX ACCESSORIES**  
Page 151

# GOCCIA 35

## *Design*

The MINIMAL shower system: reduced dimensions for a range of complete solutions.  
For glass thicknesses 6 or 8 mm, with a maximum load of 35 kg.

Finished track and aluminium cover.  
**MAXIMUM AESTHETICS AND FUNCTIONALITY**  
Complete kits for every type of installation, including STOPS or SOFTBREAK dampers.  
Simple installation with the utmost long-term functionality.



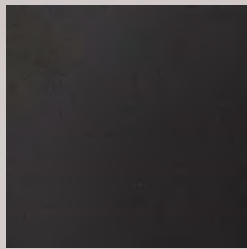

**/6**  
Matt Black



**/88**  
Brushed steel effect  
aluminium

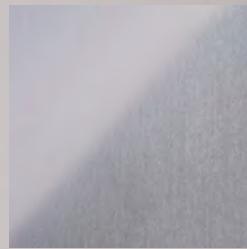

**/91**  
Polished aluminium

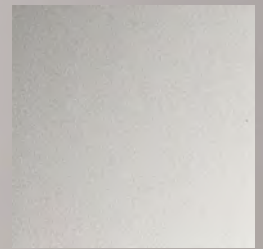

**/97**  
Matt aluminium



# GOCCIA 35

## Technical properties

The system has a unique load-bearing aluminium profile, 35 mm x 40 mm, offering a wide range of personalised solutions to meet the needs of every client and supporting doors weighing up to 35 kg.

In addition, the distance between the fixed glass and moving door is just 18 mm, while the bottom rail has a quick-release mechanism to facilitate cleaning. The system includes a dual Softbreak damper system when opening and closing the door, with a stopping distance of 60 mm.

The unique feature of this system is the ease of assembly. It is also highly functional and reliable over time.

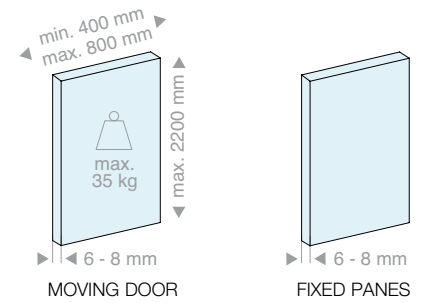

### 4 configurations

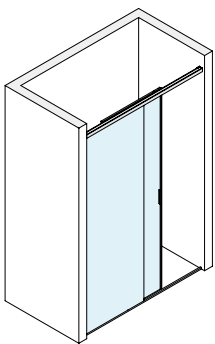

Wall/Wall

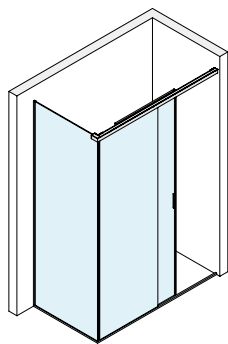

Wall/Glass

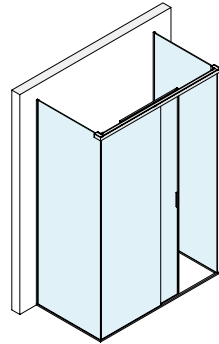

Glass/Glass

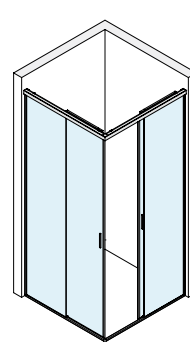

Wall/Corner/Wall



### 2 types of installation

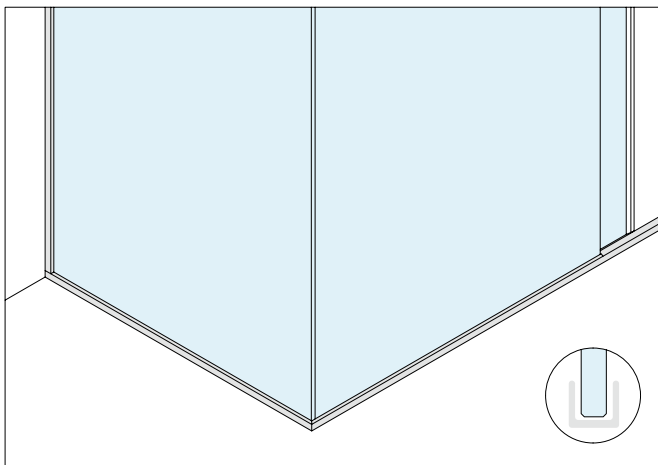

#### Linea U

*For framed fixed panes*

Simple, modern design. With Linea U, fixed panes are held within a 15 mm x 16 mm aluminium profile. The same profile, with an upper snap-on cover, acts as a water barrier in the open area.

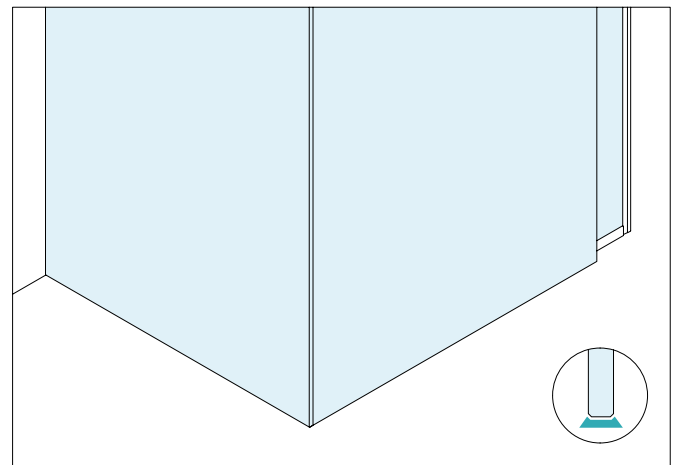
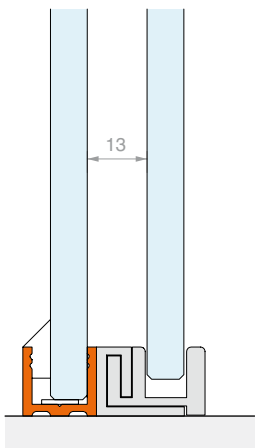

#### Linea S

*For sealed fixed panes*

Elegance and perfect transparency. With Linea S, fixed panes are sealed to the supporting surface. A space-saving water barrier profile in aluminium, 8 mm x 10 mm, can be installed at the opening.

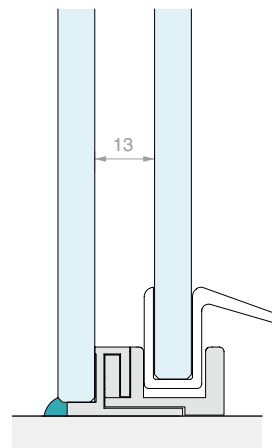

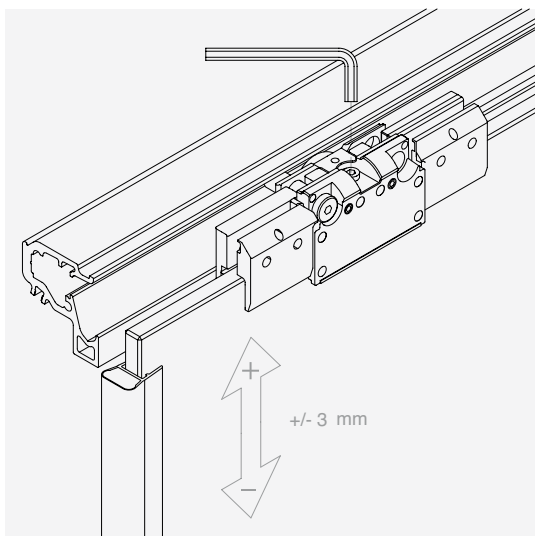

**DOOR ADJUSTMENT**

The height of each carrier can be adjusted to regulate the position of the door.

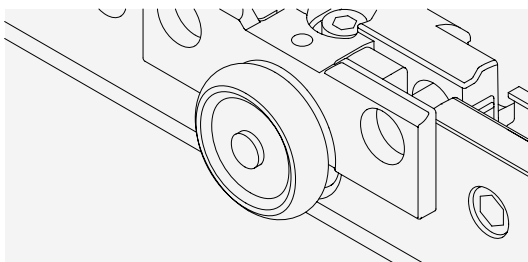

**SILENT**

The roller, with its steel bearing, provides silent and long-lasting operation

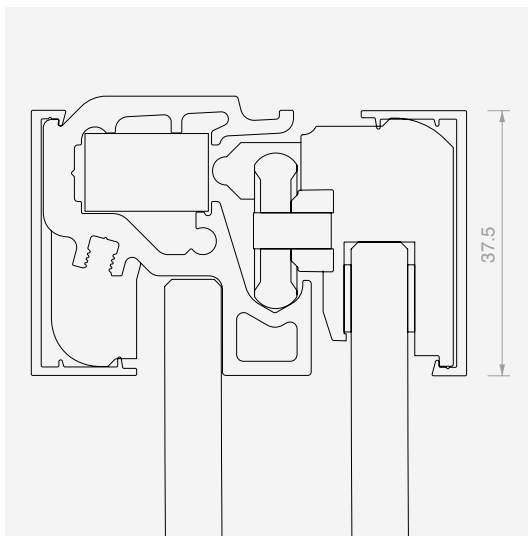

**COMPACT DESIGN**

Complete functionality in a reduced space

**SOFT BREAK**

The use of dampers reduces the speed of the door, attenuating impacts and allowing for controlled, noise-free movement.

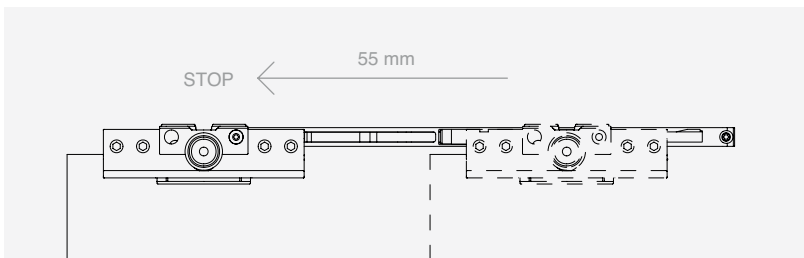

**CLEANING**

The sliding door can be detached with PUSH & UNLOCK functionality

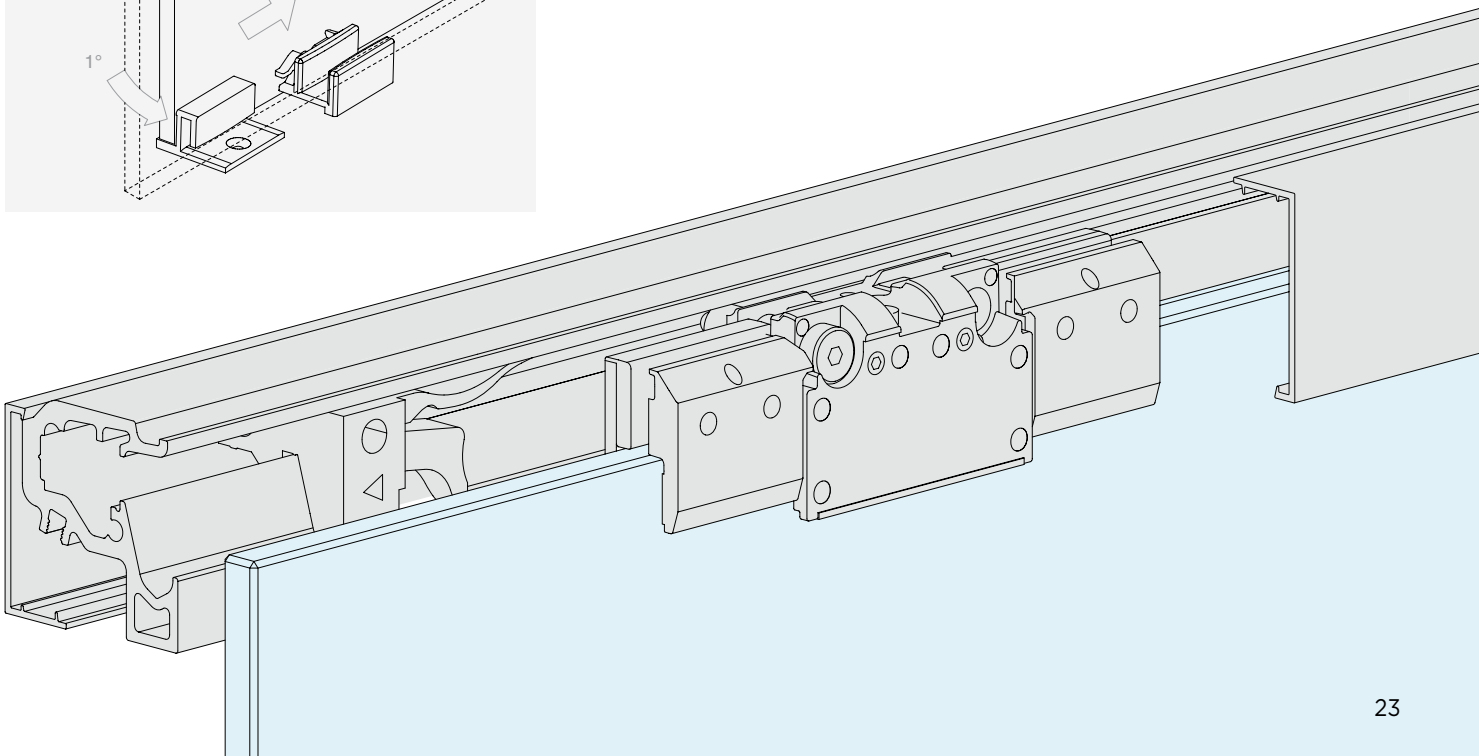
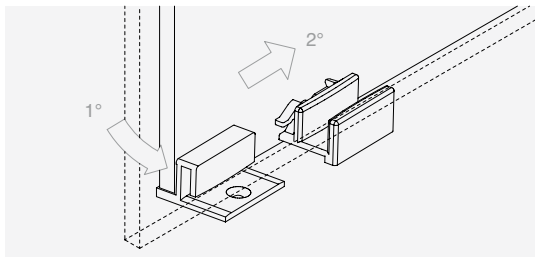





# GOCCIA 35

*Kit*



## CONFIGURATIONS WITH FRAMED FIXED PANES

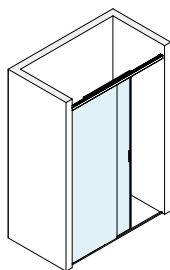

Page 27

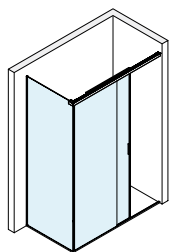

Page 29

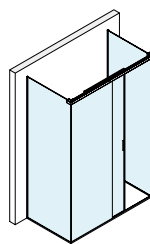

Page 31

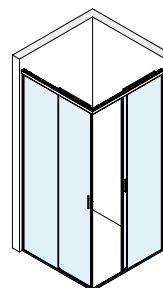

Page 33

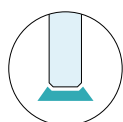

## CONFIGURATIONS WITH SEALED FIXED PANES

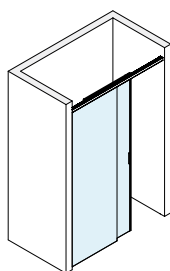

Page 34

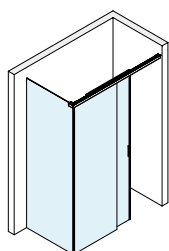

Page 36

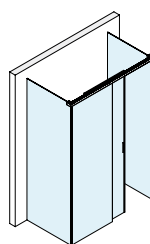

Page 38

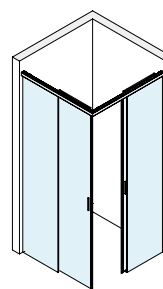

Page 40





**WALL/WALL SLIDING DOOR SHOWER KIT WITH FRAME PROFILE FOR FIXED PANE**

Finish: /6 /88 /91 /97

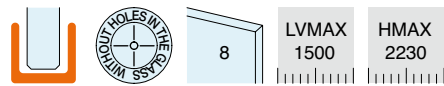
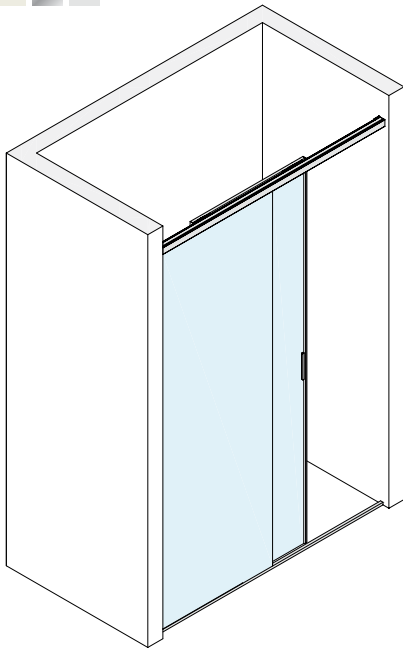

RECOMMENDED LAYOUTS

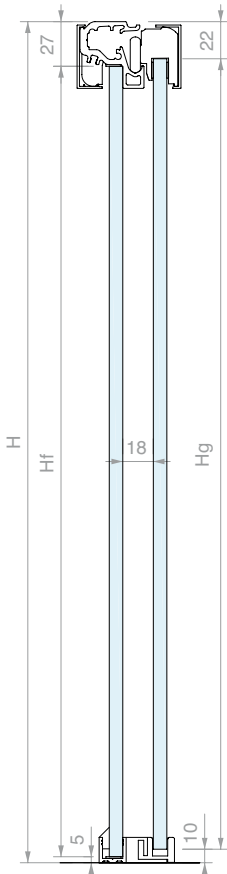

GLASS PANE DIMENSIONS

$L_g = (LV + 32) / 2$   
 $L_f = L_g$

$H_g = H - 32$   
 $H_f = H_g$

$LA = (LV - 148) / 2$

Kit comprising:

Art.	Description	Qty
<b>G35KIT01</b>	Gripper	2 Pcs
<b>G35KIT02</b>	Fixed glass	1 Pc
<b>G35KIT03</b>	Kit of 2 wall fixings	1 Pc
<b>G35KIT06</b>	Kit of 2 open caps	1 Pc
<b>MAN500V150</b>	Adhesive handle	2 Pcs
<b>LM3538.150</b>	Track	1 Pc
<b>LM3515.150</b>	Cover	1 Pc
<b>LM3515.075</b>	Cover	1 Pc
<b>GM0522</b>	Balloon gasket	1 Pc
<b>GM702022</b>	Gasket with side lip	1 Pc
<b>DCU208SCT</b>	Snap-on floor guide	1 Pc
<b>PBD3184.100</b>	Rounded upper profile	1 Pc
<b>PBD3183.150</b>	U-shaped profile	1 Pc
<b>PBD3183.220</b>	U-shaped profile	1 Pc
<b>GTUP4</b>	Glass holder gasket	4 m

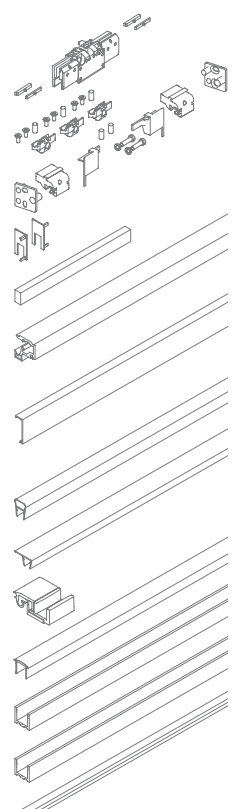

Only in the kit with stop mechanism

<b>G35KIT07</b>	Kit of 2 stops	1 Pc
-----------------	----------------	------

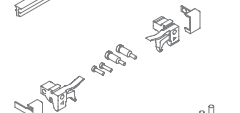

Only in the kit with softbreak damper

<b>G35KIT08</b>	Damper kit	2 Pcs
-----------------	------------	-------

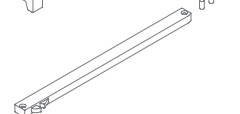

CLOSED SLIDING DOOR CONFIGURATION

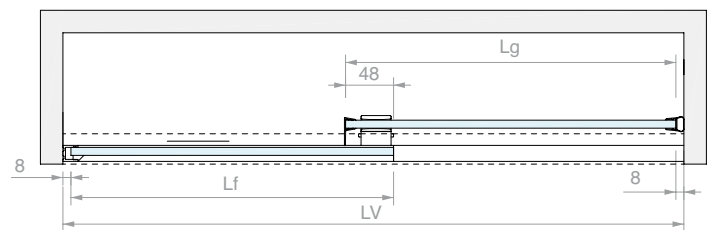

OPEN SLIDING DOOR CONFIGURATION

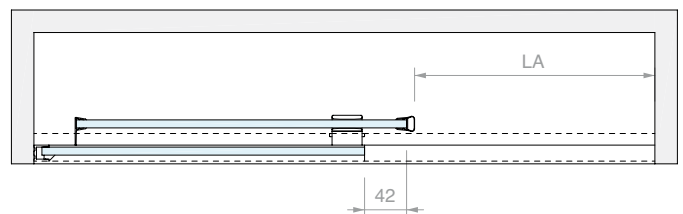

PRIMARY LENGTHS (mm)

LV	Lg	Lf	LA
1500	766	766	676
1400	716	716	626
1300	666	666	576
1200	616	616	526

Art.	Description	Qty
<b>G35U10STP</b>	With stop mechanism	1 Pc
<b>G35U10DMP</b>	With softbreak damper	1 Pc





**WALL/GLASS SLIDING DOOR SHOWER KIT WITH FRAME PROFILE FOR FIXED PANES**

Finish: /6 /88 /91 /97

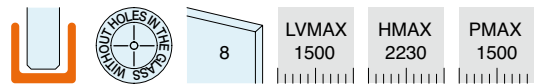
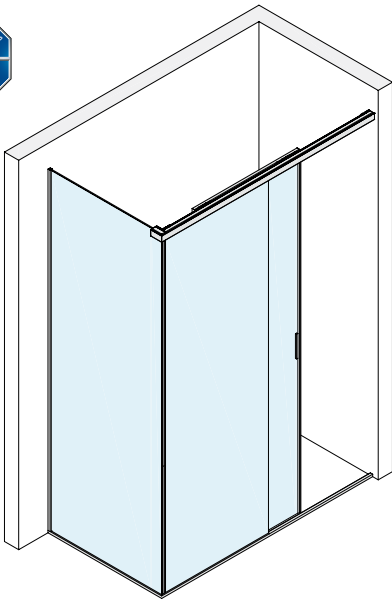

RECOMMENDED LAYOUTS

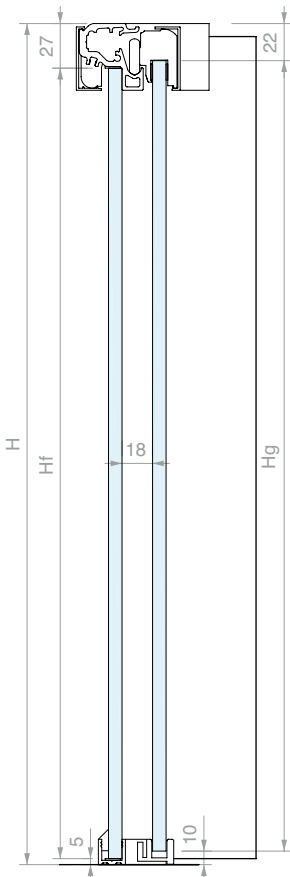

GLASS PANE DIMENSIONS

$L_g = (L_v + 24) / 2$   
 $L_f = L_g$   
 $H_g = H - 32$   
 $H_f = H_g$   
 $L_i = P - 14$   
 $H_i = H - 14$   
 $L_A = (L_v - 140) / 2$

Kit comprising:

Art.	Description	Qty
<b>G35KIT01</b>	Gripper	2 Pcs
<b>G35KIT02</b>	Fixed glass installation kit	1 Pc
<b>G35KIT03</b>	Kit of 2 wall fixings	1 Pc
<b>G35KIT04</b>	Glass fixing kit	1 Pc
<b>G35KIT06</b>	Kit of 2 open caps	1 Pc
<b>MAN500V150</b>	Adhesive handle	2 Pcs
<b>LM3538.150</b>	Track	1 Pc
<b>LM3515.15045</b>	45° cover	1 Pc
<b>LM3515.075</b>	Cover	1 Pc
<b>GM0522</b>	Balloon gasket	1 Pc
<b>GM702022</b>	Gasket with side lip	1 Pc
<b>DCU208SCT</b>	Snap-on floor guide	1 Pc
<b>PBD3184.100</b>	Rounded upper profile	1 Pc
<b>PBD3183.150</b>	U-shaped profile	2 Pcs
<b>PBD3183.220</b>	U-shaped profile	1 Pc
<b>GTUP4</b>	Glass holder gasket	6 m
Only in the kit with stop mechanism		
<b>G35KIT07</b>	Kit of 2 stops	1 Pc
Only in the kit with softbreak damper		
<b>G35KIT08</b>	Damper kit	2 Pcs

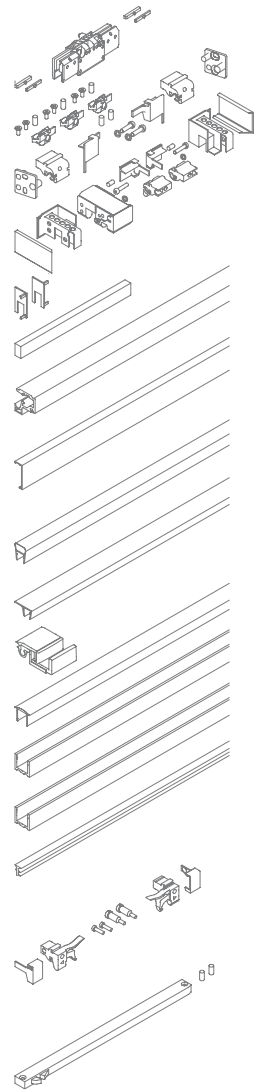

CLOSED SLIDING DOOR CONFIGURATION

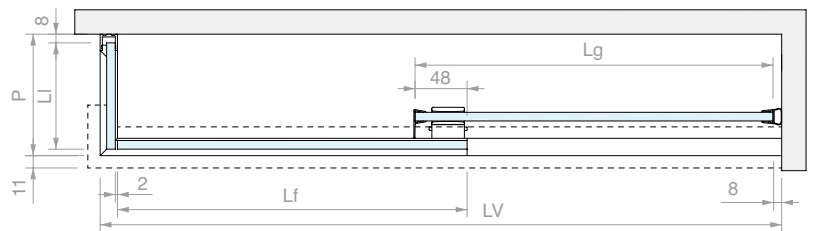

OPEN SLIDING DOOR CONFIGURATION

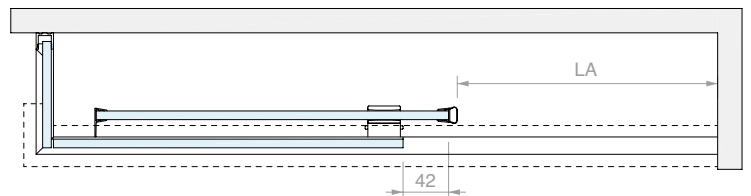

PRIMARY LENGTHS (mm)

LV	Lg	Lf	LA
1500	762	762	680
1400	712	712	630
1300	662	662	580
1200	612	612	530

Art.	Description	Qty
<b>G35U20STP</b>	With stop mechanism	1 Pc
<b>G35U20DMP</b>	With softbreak damper	1 Pc





**GLASS/GLASS SLIDING DOOR SHOWER KIT WITH FRAME PROFILE FOR FIXED PANES**

Finish: /6 /88 /91 /97

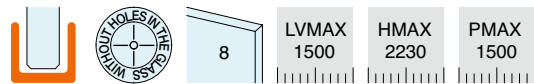
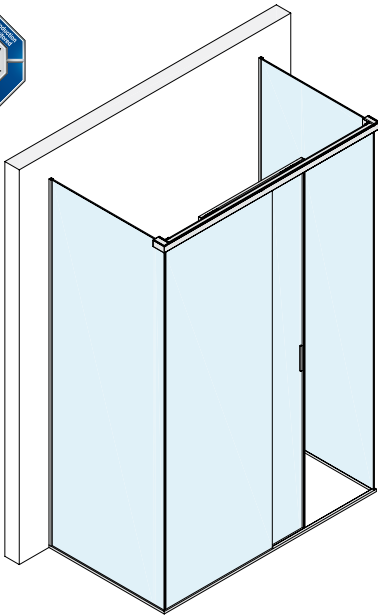

RECOMMENDED LAYOUTS

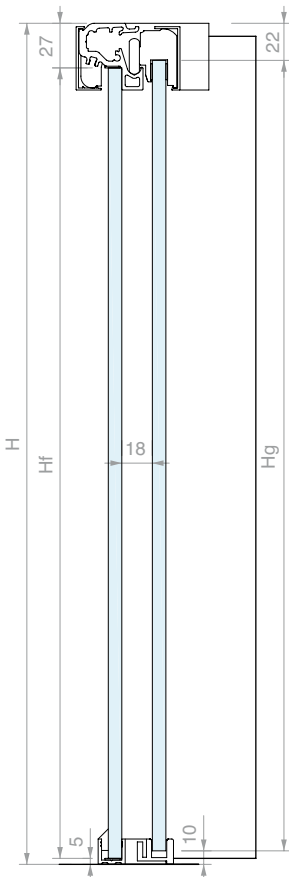

GLASS PANE DIMENSIONS

$L_g = (L_v + 10) / 2$

$L_f = L_g$

$H_g = H - 32$

$H_f = H_g$

$L_i = P - 14$

$H_i = H - 14$

$L_A = (L_v - 170) / 2$

Kit comprising:

Art.	Description	Qty
<b>G35KIT01</b>	Gripper	2 Pcs
<b>G35KIT02</b>	Fixed glass installation kit	1 Pc
<b>G35KIT04</b>	Glass fixing kit	2 Pcs
<b>G35KIT06</b>	Kit of 2 open caps	1 Pc
<b>MAN500V150</b>	Adhesive handle	2 Pcs
<b>LM3538.150</b>	Track	1 Pc
<b>LM3515.15045</b>	45° cover	1 Pc
<b>LM3515.075</b>	Cover	1 Pc
<b>GM0522</b>	Balloon gasket	1 Pc
<b>GM702022</b>	Gasket with side lip	1 Pc
<b>DCU208SCT</b>	Snap-on floor guide	1 Pc
<b>PBD3184.100</b>	Rounded upper profile	1 Pc
<b>PBD3183.150</b>	U-shaped profile	3 Pcs
<b>PBD3183.220</b>	U-shaped profile	2 Pcs
<b>GTUP4</b>	Glass holder gasket	8 m

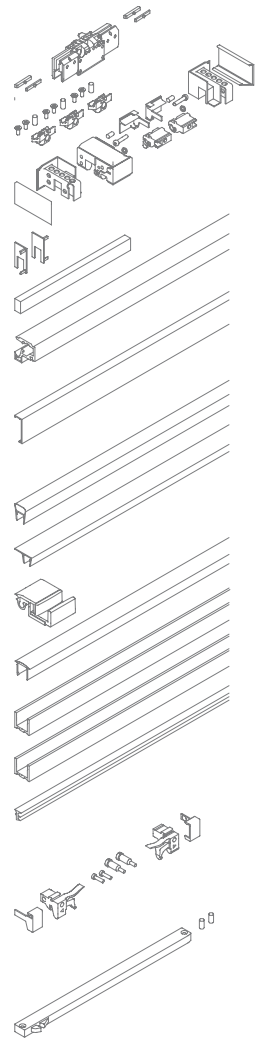

Only in the kit with stop mechanism

<b>G35KIT07</b>	Kit of 2 stops	1 Pc
-----------------	----------------	------

Only in the kit with softbreak damper

<b>G35KIT08</b>	Damper kit	2 Pcs
-----------------	------------	-------

CLOSED SLIDING DOOR CONFIGURATION

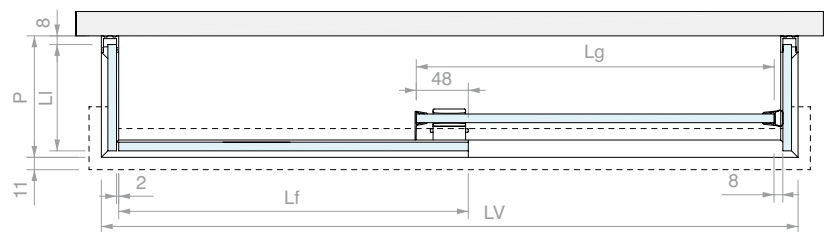

OPEN SLIDING DOOR CONFIGURATION

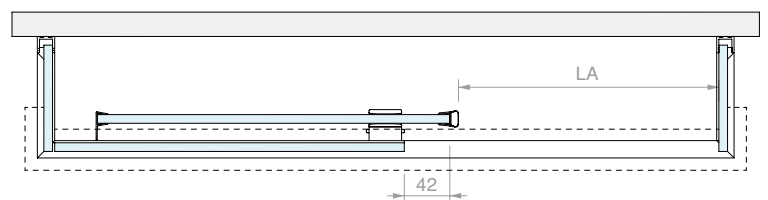

PRIMARY LENGTHS (mm)

LV	Lg	Lf	LA
1500	755	755	665
1400	705	705	615
1300	655	655	565
1200	605	605	515

Art.	Description	Qty
<b>G35U30STP</b>	With stop mechanism	1 Pc
<b>G35U30DMP</b>	With softbreak damper	1 Pc







**WALL/CORNER/WALL SLIDING DOOR SHOWER KIT WITH FRAME PROFILE FOR FIXED PANES**

Finish: /6 /88 /91 /97

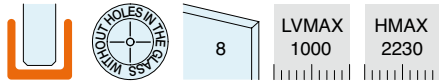
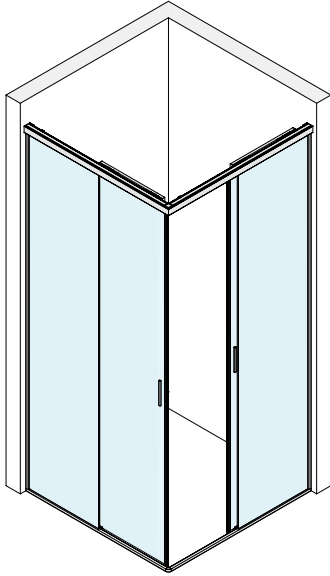

RECOMMENDED LAYOUTS

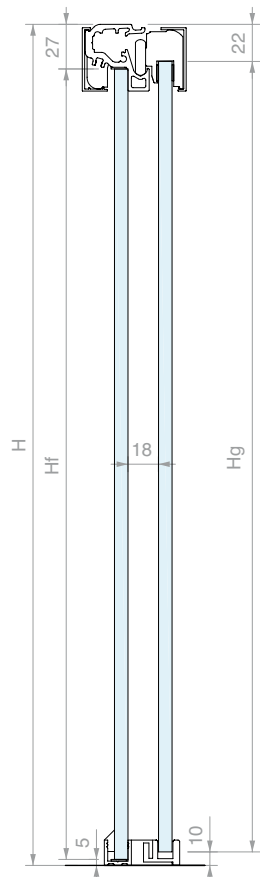

CLOSED SLIDING DOOR CONFIGURATION

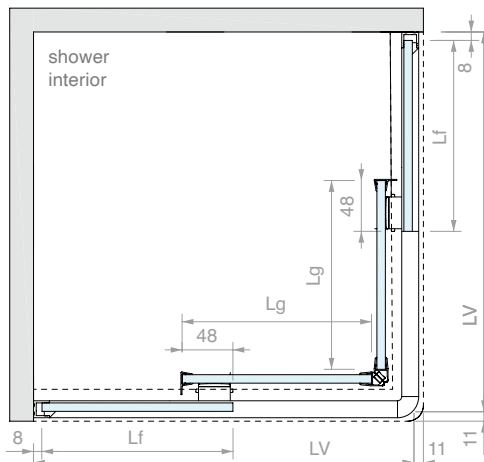

GLASS PANE DIMENSIONS

$L_g = (LV - 6) / 2$   
 $L_f = L_g$   
 $H_g = H - 32$   
 $H_f = H_g$   
 $LA = 0.7 \times (LV - 180)$

OPEN SLIDING DOOR CONFIGURATION

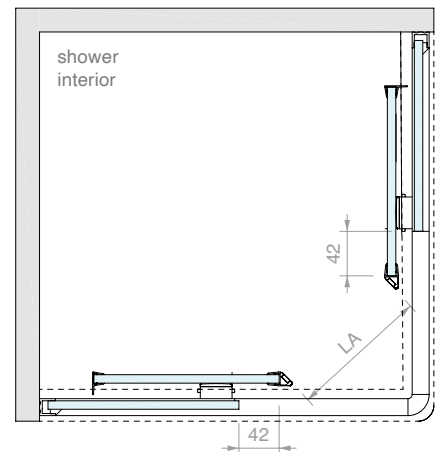

PRIMARY LENGTHS (mm)

LV	Lg	Lf	LA
1000	497	497	574
900	447	447	504
800	397	397	434

Kit comprising:

Art.	Description	Qty
<b>G35KIT01</b>	Gripper	4 Pcs
<b>G35KIT02</b>	Fixed glass installation kit	2 Pcs
<b>G35KIT03</b>	Kit of 2 wall fixings	1 Pc
<b>G35KIT05</b>	Corner junction kit	1 Pc
<b>G35KIT06</b>	Kit of 2 open caps	2 Pcs
<b>MAN500V150</b>	Adhesive handle	4 Pcs
<b>LM3538.100</b>	Track	2 Pcs
<b>LM3515.10045</b>	45° cover	2 Pcs
<b>LM3515.075</b>	Cover	2 Pcs
<b>GM62SX</b>	45° magnetic gasket	1 Pc
<b>GM62DX</b>	45° magnetic gasket	1 Pc
<b>GM702022</b>	Gasket with side lip	2 Pcs
<b>DCU208SCT</b>	Snap-on floor guide	2 Pcs
<b>PBD3184.100</b>	Rounded upper profile	2 Pcs
<b>PBD3183.150</b>	U-shaped profile	2 Pcs
<b>PBD3183.220</b>	U-shaped profile	2 Pcs
<b>GTUP4</b>	Glass holder gasket	8 m
<b>DCC90</b>	Corner junction	1 Pc
Only in the kit with stop mechanism		
<b>G35KIT07</b>	Kit of 2 stops	1 Pc
Only in the kit with softbreak damper		
<b>G35KIT08</b>	Damper kit	2 Pcs

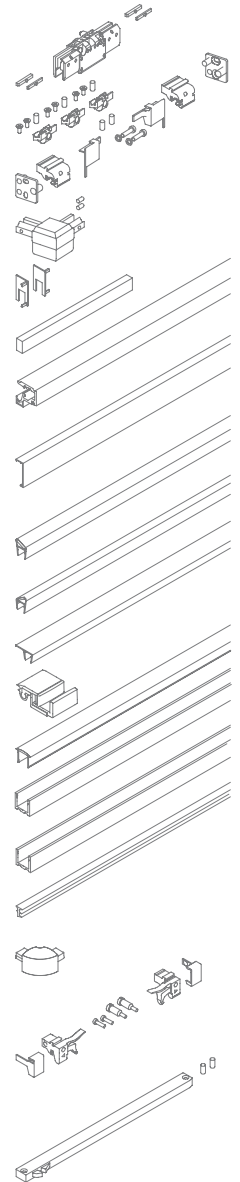

Art.	Description	Qty
<b>G35U40STP</b>	With stop mechanism	1 Pc
<b>G35U40DMP</b>	With softbreak damper	1 Pc



WALL/WALL SLIDING DOOR SHOWER KIT FOR SEALED FIXED PANE

Finish: /6 /88 /91 /97

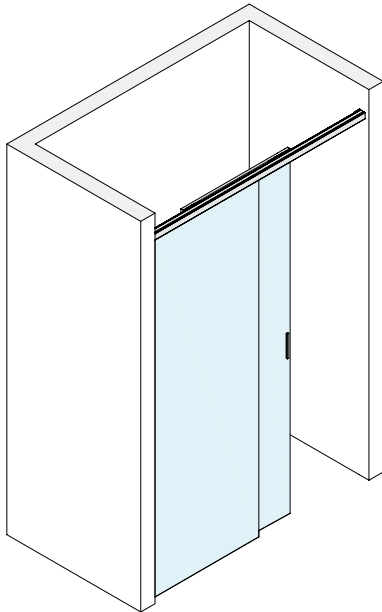

Kit comprising:

Art.	Description	Qty
<b>G35KIT01</b>	Gripper	2 Pcs
<b>G35KIT02</b>	Fixed glass installation kit	1 Pc
<b>G35KIT03</b>	Kit of 2 wall fixings	1 Pc
<b>G35KIT06</b>	Kit of 2 open caps	1 Pc
<b>MAN500V150</b>	Adhesive handle	2 Pcs
<b>LM3538.150</b>	Track	1 Pc
<b>LM3515.150</b>	Cover	1 Pc
<b>LM3515.075</b>	Cover	1 Pc
<b>DCS208</b>	Floor guide	1 Pc
<b>GM900807</b>	Gasket with drip flap	1 Pc

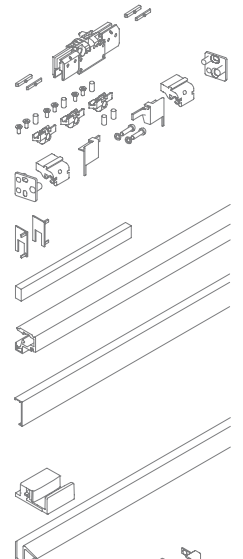

Only in the kit with stop mechanism

<b>G35KIT07</b>	Kit of 2 stops	1 Pc
-----------------	----------------	------

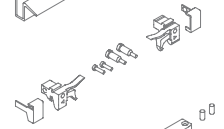

Only in the kit with softbreak damper

<b>G35KIT08</b>	Damper kit	2 Pcs
-----------------	------------	-------



Optional

<b>GM0522</b>	Balloon gasket	1 Pc
<b>GM072022</b>	Gasket with side lip	1 Pc
<b>PESQ0810.075</b>	Water barrier profile	1 Pc

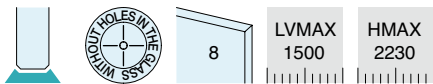
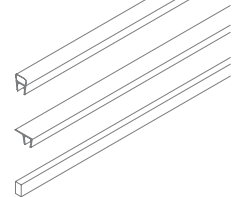

RECOMMENDED LAYOUTS

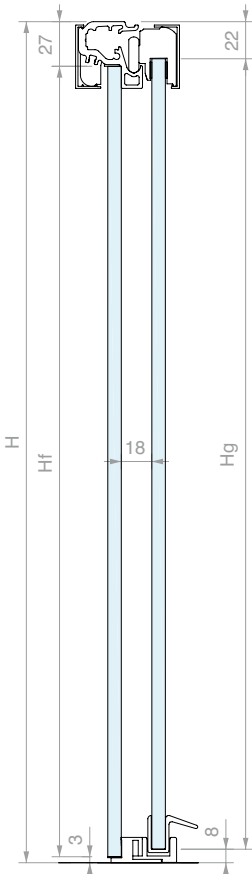

GLASS PANE DIMENSIONS

$$L_g = (L_V + 38) / 2$$

$$L_f = L_g$$

$$H_g = H - 30$$

$$H_f = H_g$$

$$L_A = (L_V - 126) / 2$$

CLOSED SLIDING DOOR CONFIGURATION

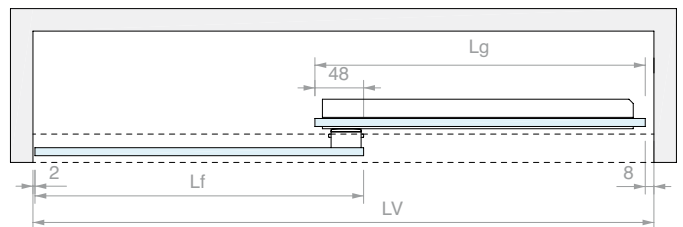

OPEN SLIDING DOOR CONFIGURATION

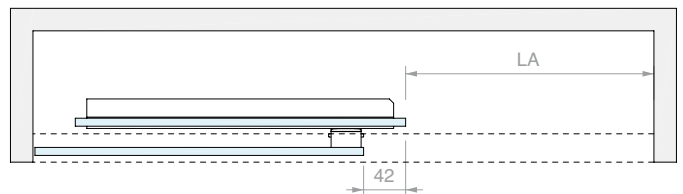

PRIMARY LENGTHS (mm)

L <sub>V</sub>	L <sub>g</sub>	L <sub>f</sub>	L <sub>A</sub>
1500	769	769	687
1400	719	719	637
1300	669	669	587
1200	619	619	537

Art.	Description	Qty
<b>G35S10STP</b>	With stop mechanism	1 Pc
<b>G35S10DMP</b>	With softbreak damper	1 Pc



**WALL/GLASS SLIDING DOOR SHOWER KIT FOR SEALED FIXED PANES**

Finish: /6 /88 /91 /97

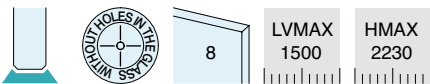
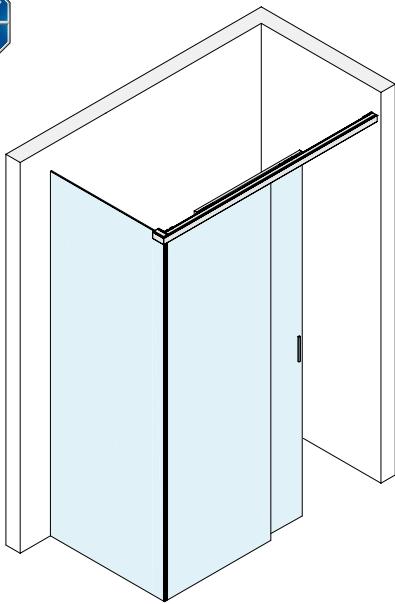

**RECOMMENDED LAYOUTS**

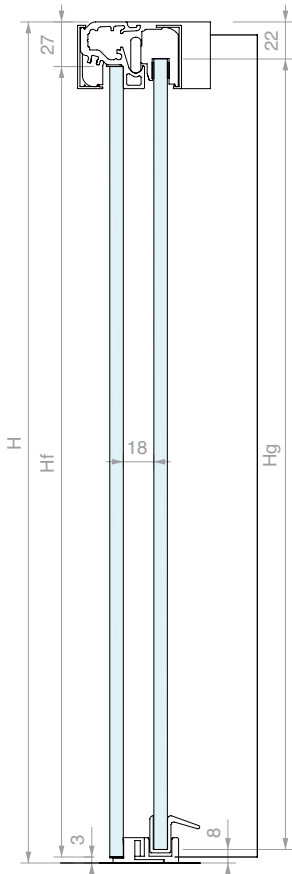

**GLASS PANE DIMENSIONS**

$$L_g = (LV + 38) / 2$$

$$L_f = L_g$$

$$H_g = H - 30$$

$$H_f = H_g$$

$$L_A = (LV - 126) / 2$$

Kit comprising:

Art.	Description	Qty
<b>G35KIT01</b>	Gripper	2 Pcs
<b>G35KIT02</b>	Fixed glass installation kit	1 Pc
<b>G35KIT03</b>	Kit of 2 wall fixings	1 Pc
<b>G35KIT04</b>	Glass fixing kit	1 Pc
<b>G35KIT06</b>	Kit of 2 open caps	1 Pc
<b>MAN500V150</b>	Adhesive handle	2 Pcs
<b>LM3538.150</b>	Track	1 Pc
<b>LM3515.15045</b>	45° cover	1 Pc
<b>LM3515.075</b>	Cover	1 Pc
<b>DCS208</b>	Floor guide	1 Pc
<b>GM900807</b>	Gasket with drip flap	1 Pc
Only in the kit with stop mechanism		
<b>G35KIT07</b>	Kit of 2 stops	1 Pc
Only in the kit with softbreak damper		
<b>G35KIT08</b>	Damper kit	2 Pcs
Optional		
<b>GM0522</b>	Balloon gasket	1 Pc
<b>GM072022</b>	Gasket with side lip	1 Pc
<b>PESQ0810.075</b>	Water barrier profile	1 Pc

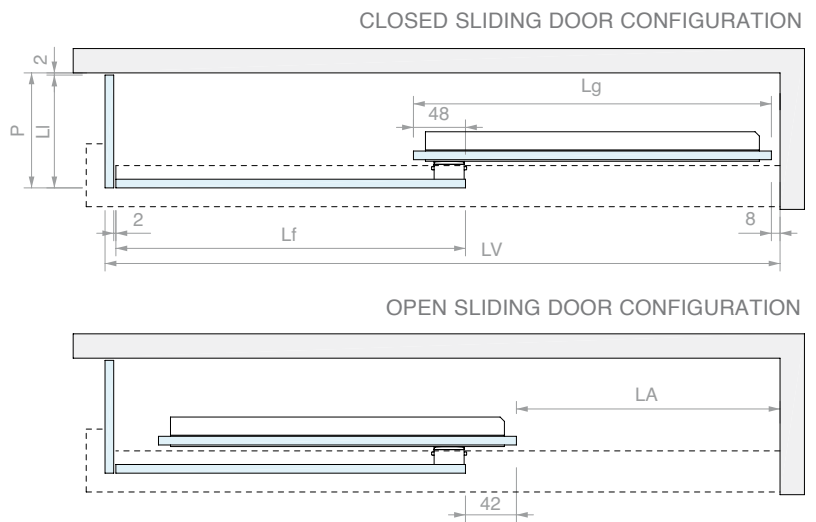

**PRIMARY LENGTHS (mm)**

LV	Lg	Lf	LA
1500	769	769	687
1400	719	719	637
1300	669	669	587
1200	619	619	537

Art.	Description	Qty
<b>G35S20STP</b>	With stop mechanism	1 Pc
<b>G35S20DMP</b>	With softbreak damper	1 Pc





**GLASS/GLASS SLIDING DOOR SHOWER KIT FOR SEALED FIXED PANES**

Finish: /6 /88 /91 /97

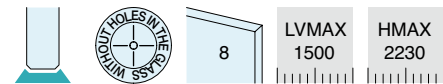
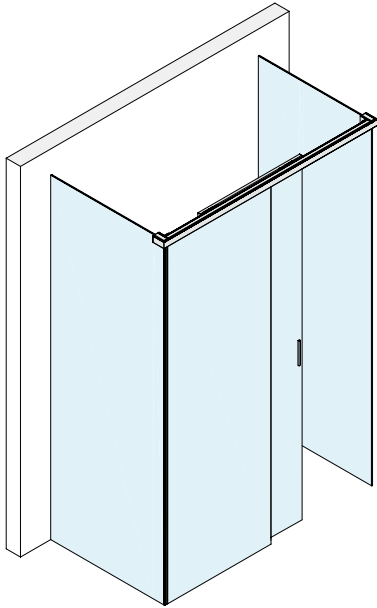

RECOMMENDED LAYOUTS

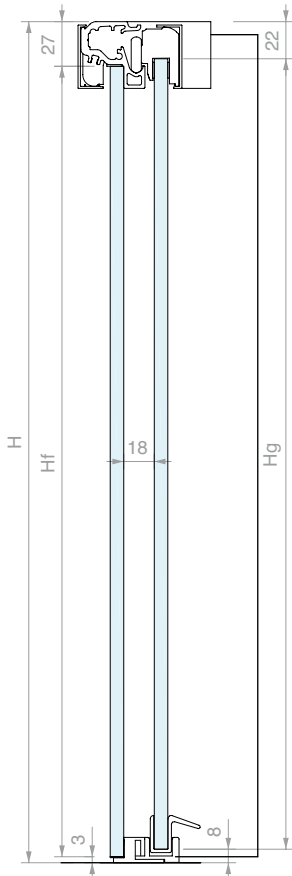

GLASS PANE DIMENSIONS

$$L_g = (L_v + 22) / 2$$

$$L_f = L_g$$

$$H_g = H - 30$$

$$H_f = H_g$$

$$L_i = P - 2$$

$$H_i = H - 12$$

$$L_A = (L_v - 138) / 2$$

Kit comprising:

Art.	Description	Qty
<b>G35KIT01</b>	Gripper	2 Pcs
<b>G35KIT02</b>	Fixed glass installation kit	1 Pc
<b>G35KIT04</b>	Glass fixing kit	2 Pcs
<b>G35KIT06</b>	Kit of 2 open caps	1 Pc
<b>MAN500V150</b>	Adhesive handle	2 Pcs
<b>LM3538.150</b>	Track	1 Pc
<b>LM3515.15045</b>	45° cover	1 Pc
<b>LM3515.075</b>	Cover	1 Pc
<b>DCS208</b>	Floor guide	1 Pc
<b>GM900807</b>	Gasket with drip flap	1 Pc
Only in the kit with stop mechanism		
<b>G35KIT07</b>	Kit of 2 stops	1 Pc
Only in the kit with softbreak damper		
<b>G35KIT08</b>	Damper kit	2 Pcs
Optional		
<b>GM0522</b>	Balloon gasket	1 Pc
<b>GM072022</b>	Gasket with side lip	1 Pc
<b>PESQ0810.075</b>	Water barrier profile	1 Pc

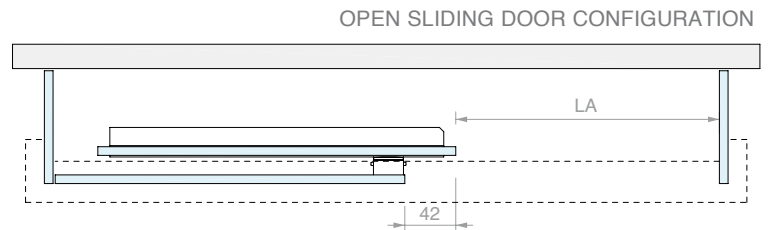
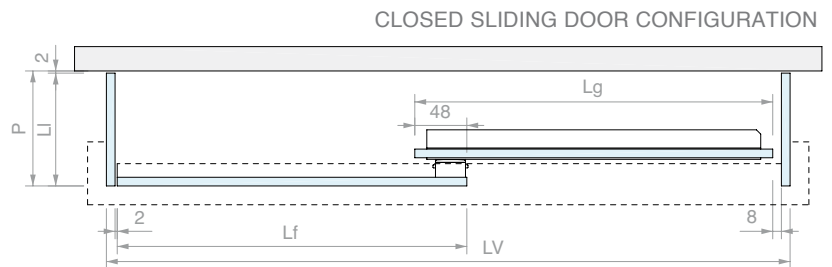

PRIMARY LENGTHS (mm)

LV	Lg	Lf	LA
1500	761	761	681
1400	711	711	631
1300	661	661	581
1200	611	611	531

Art.	Description	Qty
<b>G35S30STP</b>	With stop mechanism	1 Pc
<b>G35S30DMP</b>	With softbreak damper	1 Pc





WALL/CORNER/WALL SLIDING DOOR SHOWER KIT FOR SEALED FIXED PANES

Finish: /6 /88 /91 /97

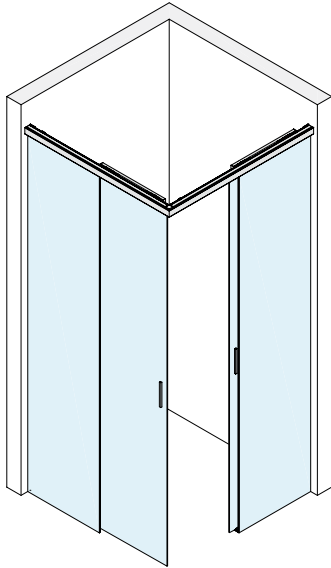

Kit comprising:

Art.	Description	Qty
<b>G35KIT01</b>	Gripper	4 Pcs
<b>G35KIT02</b>	Fixed glass installation kit	2 Pcs
<b>G35KIT03</b>	Kit of 2 wall fixings	1 Pc
<b>G35KIT05</b>	Corner junction kit	1 Pc
<b>G35KIT06</b>	Kit of 2 open caps	2 Pcs
<b>MAN500V150</b>	Adhesive handle	4 Pcs
<b>LM3538.100</b>	Track	2 Pcs
<b>LM3515.10045</b>	45° cover	2 Pcs
<b>LM3515.075</b>	Cover	2 Pcs
<b>DCS208</b>	Floor guide	2 Pcs
<b>GM900807</b>	Gasket with drip flap	2 Pcs
Only in the kit with stop mechanism		
<b>G35KIT07</b>	Kit of 2 stops	2 Pcs
Only in the kit with softbreak damper		
<b>G35KIT08</b>	Damper kit	4 Pcs
Optional		
<b>GM62SX</b>	45° magnetic gasket	1 Pc
<b>GM62DX</b>	45° magnetic gasket	1 Pc
<b>PESQ0810.075</b>	Water barrier profile	1 Pc
<b>RA9008</b>	Corner joint for water barrier profile	1 Pc

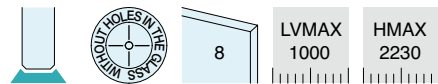

RECOMMENDED LAYOUTS

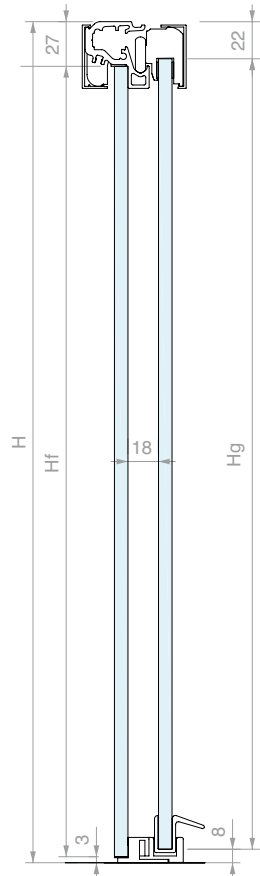

CLOSED SLIDING DOOR CONFIGURATION

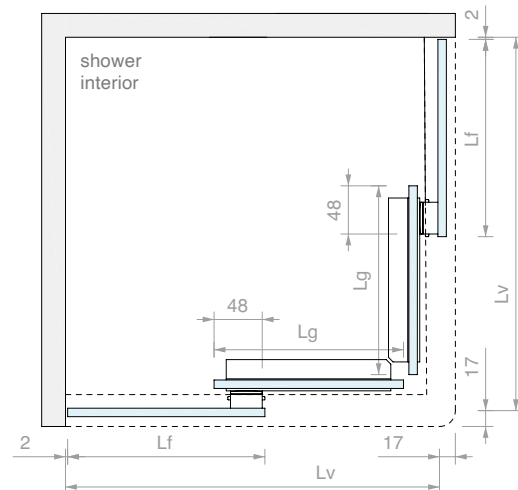

OPEN SLIDING DOOR CONFIGURATION

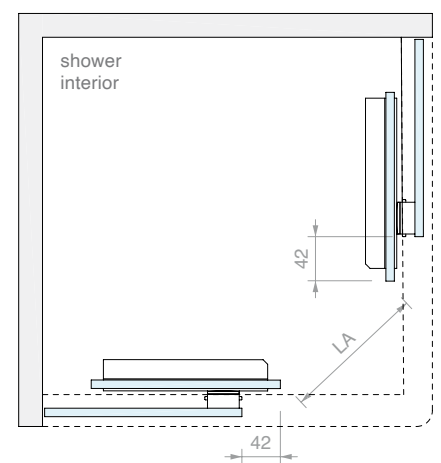

GLASS PANE DIMENSIONS

$Lg = (LV + 6) / 2$   
 $Lf = Lg$   
 $Hg = H - 30$   
 $Hf = Hg$   
 $LA = 0.7 \times (LV - 160)$

PRIMARY LENGTHS (mm)









LV	Lg	Lf	LA
1000	503	503	588
900	453	453	518
800	403	403	418

Art.	Description	Qty
<b>G35S40STP</b>	With stop mechanism	1 Pc
<b>G35S40DMP</b>	With softbreak damper	1 Pc





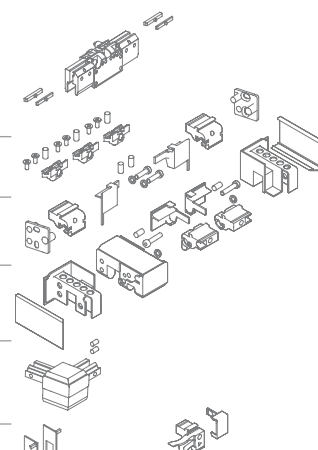

										
G35U10	G35U20	G35U30	G35U40	G35S10	G35S20	G35S30	G35S40			
2 Pcs	2 Pcs	2 Pcs	4 Pcs	2 Pcs	2 Pcs	2 Pcs	4 Pcs	<b>G35KIT01</b>	⊙	
1 Pc	1 Pc	1 Pc	2 Pcs	1 Pc	1 Pc	1 Pc	2 Pcs	<b>G35KIT02</b>	⊙	
1 Pc	1 Pc		1 Pc	1 Pc	1 Pc		1 Pc	<b>G35KIT03</b>	⊙	
	1 Pc	2 Pcs			1 Pc	2 Pcs		<b>G35KIT04</b>	⊙	
			1 Pc				1 Pc	<b>G35KIT05</b>	⊙	
1 Pc	1 Pc	1 Pc	2 Pcs	1 Pc	1 Pc	1 Pc	2 Pcs	<b>G35KIT06</b>	⊙	
1 Pc G35U10STP	1 Pc G35U20STP	1 Pc G35U30STP	2 Pcs G35U40STP	1 Pc G35S10STP	1 Pc G35S20STP	1 Pc G35S30STP	2 Pcs G35S40STP	<b>G35KIT07</b>	⊙	
2 Pcs G35U10DMP	2 Pcs G35U20DMP	2 Pcs G35U30DMP	4 Pcs G35U40DMP	2 Pcs G35S10DMP	2 Pcs G35S20DMP	2 Pcs G35S30DMP	4 Pcs G35S40DMP	<b>G35KIT08</b>	⊙	
2 Pcs	2 Pcs	2 Pcs	4 Pcs	2 Pcs	2 Pcs	2 Pcs	4 Pcs	<b>MAN500V150</b>	⊙	
1 Pc	1 Pc	1 Pc	4 Pcs	1 Pc	1 Pc	1 Pc		<b>LM3538.150</b> <b>LM3538.100</b>	⊙	
1 Pc 1 Pc	1 Pc 1 Pc	1 Pc 1 Pc	2 Pcs	1 Pc 1 Pc	1 Pc 1 Pc	1 Pc 1 Pc	2 Pcs	<b>LM3515.150</b> <b>LM3515.15045</b> <b>LM3515.10045</b>	⊙	
1 Pc	1 Pc	1 Pc	2 Pcs	1 Pc	1 Pc	1 Pc	2 Pcs	<b>LM3515.075</b>	⊙	
1 Pc	1 Pc	1 Pc		1 Pc OPTIONAL	1 Pc OPTIONAL	1 Pc OPTIONAL		<b>GM0622</b>	⊙	
			1 Pc				1 Pc OPTIONAL	<b>GM62DX</b>	⊙	
			1 Pc				1 Pc OPTIONAL	<b>GM62SX</b>	⊙	
1 Pc	1 Pc	1 Pc	2 Pcs	1 Pc OPTIONAL	1 Pc OPTIONAL	1 Pc OPTIONAL	2 Pcs OPTIONAL	<b>GM702022</b>	⊙	
				1 Pc	1 Pc	1 Pc	2 Pcs	<b>GM900607</b> <b>GM900807</b>	⊙	
				1 Pc	1 Pc	1 Pc	2 Pcs	<b>DCS206</b> <b>DCS208</b>	⊙ ●	
1 Pc	1 Pc	1 Pc	2 Pcs					<b>DCU206SCT</b> <b>DCU208SCT</b>	⊙ ●	
1 Pc	1 Pc	1 Pc	2 Pcs					<b>PBD3184.100</b>	⊙	
1 Pc 1 Pc	1 Pc 2 Pcs	3 Pcs 1 Pc	2 Pcs 2 Pcs					<b>PBD3183.220</b> <b>BD3183.150</b>	⊙ ⊙	
4 m	6 m	8 m	8 m					<b>GTUP6</b> <b>GTUP4</b>	⊙ ●	
			1 Pc					<b>DCC90</b>	⊙	
				1 Pc OPTIONAL	1 Pc OPTIONAL	1 Pc OPTIONAL	2 Pcs OPTIONAL	<b>PESQ0810.075</b>	⊙	
							1 Pc OPTIONAL	<b>RA9008</b>	⊙	

- ⊙ = Universal components
- = Components for 6-mm glass
- = Components for 8-mm glass



**MEASUREMENTS (mm):**

LV length at the floor

H total height

P depth at the floor (if applicable)



G35U10



G35U20



G35U30



G35U40



G35S10



G35S20



G35S30



G35S40

type of pane	dimension	pane thickness	G35U10	G35U20	G35U30	G35U40	G35S10	G35S20	G35S30	G35S40
			LV <sub>max</sub> = 1500 H <sub>max</sub> = 2230	LV <sub>max</sub> = 1500 H <sub>max</sub> = 2230 P <sub>max</sub> = 1500	LV <sub>max</sub> = 1500 H <sub>max</sub> = 2230 P <sub>max</sub> = 1500	LV <sub>max</sub> = 1000 H <sub>max</sub> = 2230	LV <sub>max</sub> = 1500 H <sub>max</sub> = 2230	LV <sub>max</sub> = 1500 H <sub>max</sub> = 2230 P <sub>max</sub> = n/a	LV <sub>max</sub> = 1500 H <sub>max</sub> = 2230 P <sub>max</sub> = n/a	LV <sub>max</sub> = 1500 H <sub>max</sub> = 2230
moving door	width (Lg)	6mm	$\frac{(LV + 32)}{2}$	$\frac{(LV + 24)}{2}$	$\frac{(LV + 8)}{2}$	$\frac{(LV - 4)}{2}$	$\frac{(LV + 38)}{2}$	$\frac{(LV + 32)}{2}$	$\frac{(LV + 26)}{2}$	$\frac{(LV + 8)}{2}$
		8mm	$\frac{(LV + 32)}{2}$	$\frac{(LV + 24)}{2}$	$\frac{(LV + 8)}{2}$	$\frac{(LV - 4)}{2}$	$\frac{(LV + 38)}{2}$	$\frac{(LV + 30)}{2}$	$\frac{(LV + 22)}{2}$	$\frac{(LV + 6)}{2}$
	height (Hg)	6-8 mm	H - 32	H - 32	H - 32	H - 32	H - 30	H - 30	H - 30	H - 30
fixed pane	width (Lf)	6mm	$\frac{(LV + 32)}{2}$	$\frac{(LV + 24)}{2}$	$\frac{(LV + 8)}{2}$	$\frac{(LV - 4)}{2}$	$\frac{(LV + 38)}{2}$	$\frac{(LV + 32)}{2}$	$\frac{(LV + 26)}{2}$	$\frac{(LV + 8)}{2}$
		8mm	$\frac{(LV + 32)}{2}$	$\frac{(LV + 24)}{2}$	$\frac{(LV + 8)}{2}$	$\frac{(LV - 4)}{2}$	$\frac{(LV + 38)}{2}$	$\frac{(LV + 30)}{2}$	$\frac{(LV + 22)}{2}$	$\frac{(LV + 6)}{2}$
	height (Hf)	6-8 mm	H - 32	H - 32	H - 32	H - 32	H - 30	H - 30	H - 30	H - 30
fixed adjustment	width (Li)	6mm	-	P - 16	P - 16	-	-	P - 2	P - 2	-
		8mm	-	P - 14	P - 14	-	-	P - 2	P - 2	-
	height (Hi)	6-8 mm	-	H - 14	H - 14	-	-	H - 12	H - 12	-

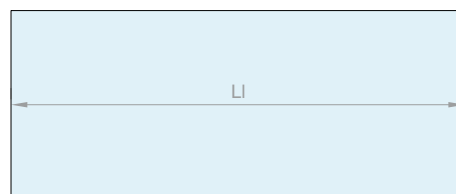
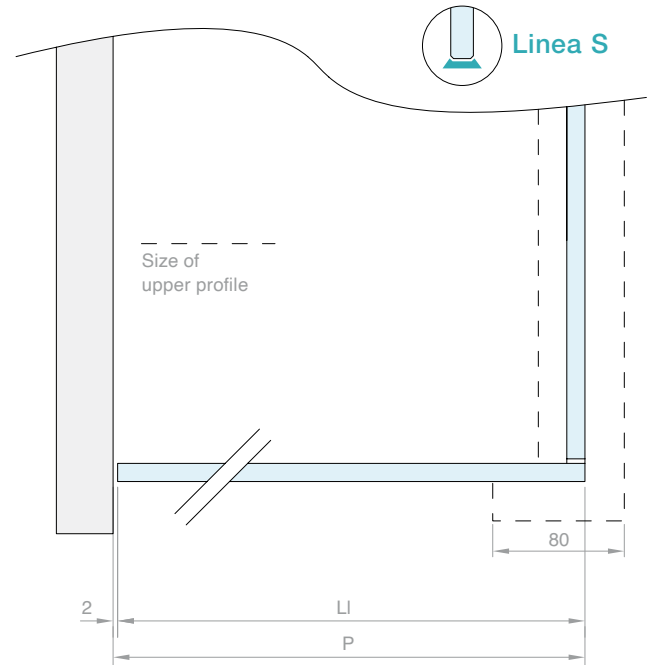
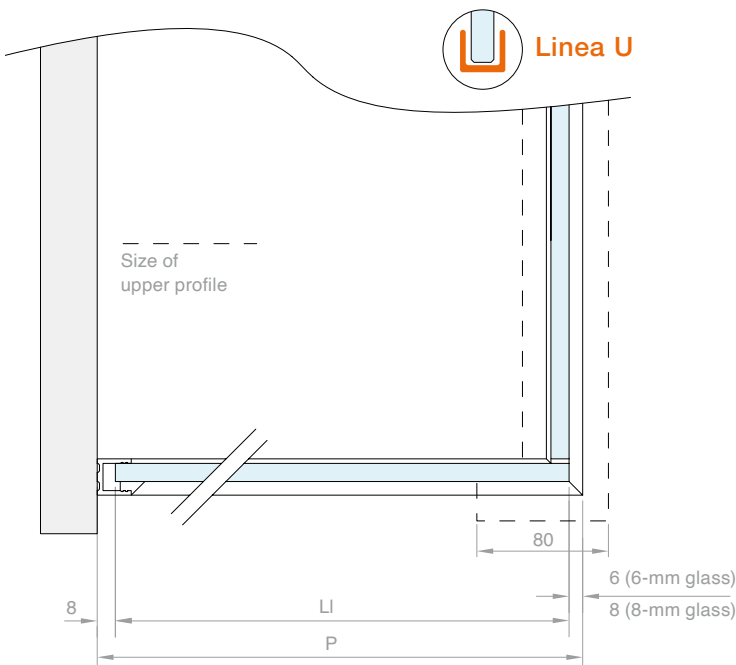

Note: Glass panes in moving doors, fixed panes, and side panes do not require processing in any configuration.



**GOCCIA35 GRIPPER**

composed of:  
1 complete gripper

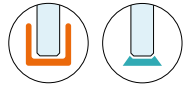

Art.	For glass	Qty
<b>G35KIT01</b>	From 6 to 8 mm	1 Pc



**FIXED GLASS**

composed of:  
3 inserts  
6 M4x8 steel countersunk screws  
3 M5x12 polyamide set screws

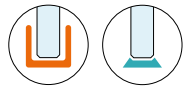

Art.	For glass	Qty
<b>G35KIT02</b>	From 6 to 8 mm	1 Pc



**KIT OF 2 WALL FIXINGS**

composed of:  
2 inserts, right and left  
2 M5x12 set screws  
2 steel toothed washers for M5 screws  
2 M5x25 steel cylindrical head screws  
2 steel plates for anchoring to the right and left walls  
2 metal covers, right and left  
Finish: /6 /88 /91 /97

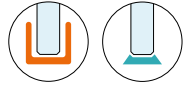

Art.	Qty
<b>G35KIT03</b>	1 Pc



**GLASS FIXING KIT**

composed of:  
1 aluminium fixing body for glass  
2 inserts, right and left  
4 M8x12 set screws  
2 steel toothed washers for M5 screws  
2 M5x30 steel cylindrical head screws  
1 M5x20 fixing set screw  
2 covers for glass fixings, right and left  
2 covers with metal finish, right and left  
Finish: /6 /88 /91 /97

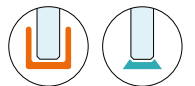

Art.	Qty
<b>G35KIT04</b>	1 Pc

**CORNER JUNCTION KIT**

composed of:

1 corner profile in aluminium finish

2 M5x20 set screws

Finish: /6 /88 /91 /97



Art.

Qty

**G35KIT05**

1 Pc

**OPEN CAP KIT FOR DOORS**

composed of:

2 open caps, right and left

Finish: /6 /88 /91 /97



Art.

For glass

Qty

**G35KIT06**

From 6 to 8 mm

1 Pc

**KIT OF 2 STOPS**

composed of:

2 POM inserts, right and left

2 special retaining screws for clamps

2 M5x12 set screws

2 covers with metal finish, right and left

Finish: /6 /88 /91 /97



Art.

Qty

**G35KIT07**

1 Pc

**DAMPER KIT**

composed of:

1 damper

2 M5x16 set screws



Art.

Qty

**G35KIT08**

1 Pc



**TRACK**

Material: Aluminium

Finish: /6 /88 /91 /97

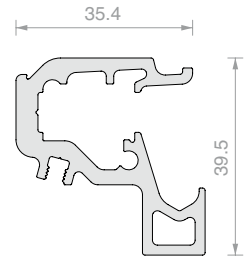
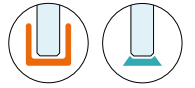

Art.	Length	Qty
<b>LM3538.100</b>	996 mm	1 Pc
<b>LM3538.150</b>	1498 mm	1 Pc
<b>LM3538.200</b>	1998 mm	1 Pc
<b>LM3538.300</b>	3000 mm	1 Pc



**TRACK COVER**

Material: Aluminium

Finish: /6 /88 /91 /97

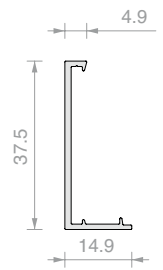
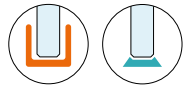

Art.	Length	Qty
<b>LM3515.075</b>	746 mm	1 Pc
<b>LM3515.10045</b>	1086 mm at 45°	1 Pc
<b>LM3515.150</b>	1498 mm	1 Pc
<b>LM3515.15045</b>	1588 mm at 45°	1 Pc
<b>LM3515.200</b>	1998 mm	1 Pc
<b>LM3515.300</b>	3000 mm	1 Pc



**U-SHAPED PROFILE**

Material: Aluminium

Finish: /6 /88 /91 /97

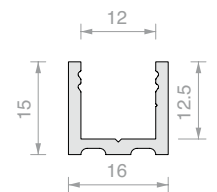

Art.	Length	Qty
<b>PBD3183.150</b>	1498 mm	1 Pc
<b>PBD3183.220</b>	2200 mm	1 Pc
<b>PBD3183</b>	3000 mm	1 Pc

**ROUNDED UPPER PROFILE PBD3184**

Material: Aluminium

Finish: /6 /88 /91 /97

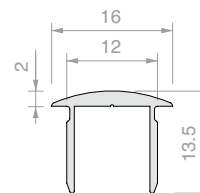

Art.	Length	Qty
<b>PBD3184.100</b>	992 mm	1 Pc
<b>PBD3184.150</b>	1498 mm	1 Pc
<b>PBD3184</b>	3000 mm	1 Pc

**ROUNDED CAP PBD**

Material: Aluminium

Finish: /6 /88 /91 /97

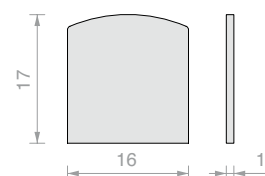

Art.	Qty
<b>PBDTP</b>	1 Pc

**FLAT UPPER PROFILE PBD3186**

Material: Aluminium

Finish: /6 /88 /91 /97

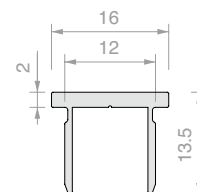

Art.	Length	Qty
<b>PBD3186.100</b>	992 mm	1 Pc
<b>PBD3186.150</b>	1498 mm	1 Pc
<b>PBD3186</b>	3000 mm	1 Pc

**PBD FLAT CAP**

Material: Aluminium

Finish: /6 /88 /91 /97

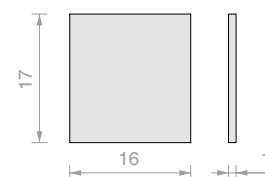

Art.	Qty
<b>PBD86TP</b>	1 Pc



**WATER BARRIER PROFILE**

Material: Aluminium

Finish: /6 /88 /91 /97

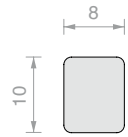

Art.	Length	Qty
<b>PESQ0810.075</b>	747 mm	1 Pc
<b>PESQ0810.150</b>	1498 mm	1 Pc
<b>PESQ0810.300</b>	3000 mm	1 Pc



**BALLOON GASKET**

Material: Co-extruded rigid and soft PVC

Fungicide to prevent mould from forming

Finishes: transparent, embossed balloon

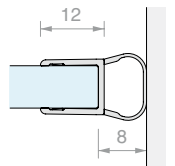
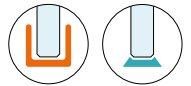

Art.	Length	For glass	Qty
<b>GM05</b>	2000 mm	From 6 to 8 mm	1 Pc
<b>GM0522</b>	2200 mm	From 6 to 8 mm	1 Pc
<b>GM052500</b>	2500 mm	From 6 to 8 mm	1 Pc
<b>GM0530</b>	3000 mm	From 6 to 8 mm	1 Pc



**MAGNETIC 45° GASKET**

Material: Co-extruded rigid and soft PVC

Resistant to UV rays

Fungicide to prevent mould from forming

Maximum operating temperature 70°C

Finish: transparent balloon, white magnet

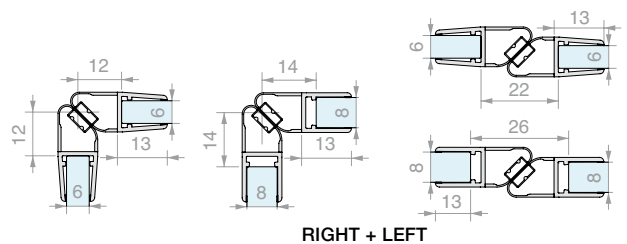

RIGHT + LEFT

Art.	Length	For glass	Qty
<b>GM62SX</b>	2200 mm	From 6 to 8 mm	1 Pc
<b>GM6230SX</b>	3000 mm	From 6 to 8 mm	1 Pc
<b>GM62DX</b>	2200 mm	From 6 to 8 mm	1 Pc
<b>GM6230DX</b>	3000 mm	From 6 to 8 mm	1 Pc





**GASKET WITH SIDE LIP**

Material: Co-extruded rigid and soft PVC  
 Resistant to UV rays  
 Fungicide to prevent mould from forming  
 Finishes: transparent, embossed lip

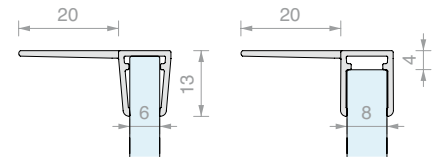
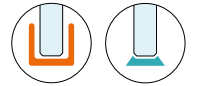

Art.	Length	For glass	Qty
<b>GM702020</b>	2000 mm	From 6 to 8 mm	1 Pc
<b>GM702022</b>	2200 mm	From 6 to 8 mm	1 Pc
<b>GM702030</b>	3000 mm	From 6 to 8 mm	1 Pc



**GLASS HOLDER GASKET**

Material: PVC



Art.	Thickness	Colour	Qty	Art.	Thickness	Colour	Qty	Art.	Thickness	Colour	Qty
<b>GTUP2</b>	2 mm	Transparent	1 m	<b>GTUP2G</b>	2 mm	Embossed	1 m	<b>GTUP2N</b>	2 mm	Black	1 m
<b>GTUP3</b>	3 mm	Transparent	1 m	<b>GTUP3G</b>	3 mm	Embossed	1 m	<b>GTUP3N</b>	3 mm	Black	1 m
<b>GTUP4</b>	4 mm	Transparent	1 m	<b>GTUP4G</b>	4 mm	Embossed	1 m	<b>GTUP4N</b>	4 mm	Black	1 m
<b>GTUP5</b>	5 mm	Transparent	1 m	<b>GTUP5G</b>	5 mm	Embossed	1 m	<b>GTUP5N</b>	5 mm	Black	1 m
<b>GTUP6</b>	6 mm	Transparent	1 m	<b>GTUP6G</b>	6 mm	Embossed	1 m	<b>GTUP6N</b>	6 mm	Black	1 m



**MAGNETIC IN-LINE GASKET**

Material: Co-extruded rigid and soft PVC  
 Resistant to UV rays  
 Fungicide to prevent mould from forming  
 Maximum operating temperature 70°C  
 Colour: transparent, embossed balloon, black magnet

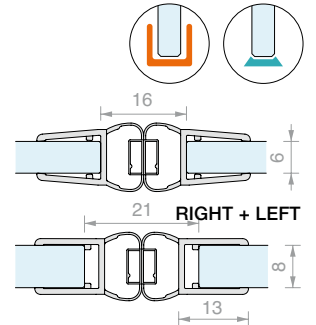

Art.	Length	For glass	Qty
<b>GM11SX</b>	2000 mm	From 6 to 8 mm	1 Pc
<b>GM11SX2500</b>	2500 mm	From 6 to 8 mm	1 Pc
<b>GM11DX</b>	2000 mm	From 6 to 8 mm	1 Pc
<b>GM11DX2500</b>	2500 mm	From 6 to 8 mm	1 Pc



**MAGNETIC EXTENSION PROFILE**

Material: Aluminium  
 Finish: /91



Glass thickness	Art.	Air between the glass and profile
6 mm	<b>GM11SX</b>	10 mm
6 mm	<b>GM66SX</b>	8 mm
8 mm	<b>GM11SX</b>	10 mm
8 mm	<b>GM66SX</b>	10 mm
6 mm	<b>GM12SX2500</b>	10 mm
8 mm	<b>GM6630SX</b>	8 mm

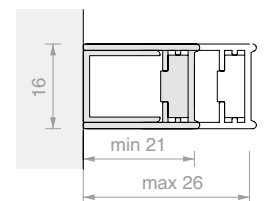

Art.	Length	Qty
<b>PBCAL10</b>	2300 mm	1 Pc





**SNAP-ON FLOOR GUIDE FOR GLASS WITH PROFILE**

Material: Zamak, ABS

Compatible with aluminium profiles in the PBD and LMU series

Finish: /1 /24 /97 /R2

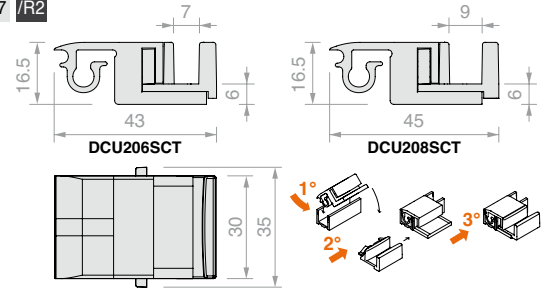

Art.	For glass	Qty
<b>DCU206SCT</b>	6 mm	1 Pc
<b>DCU208SCT</b>	8 mm	1 Pc



**FLOOR GUIDE FOR GLASS WITH PROFILE**

Material: ABS

Finish: /6 /88 /91 /97

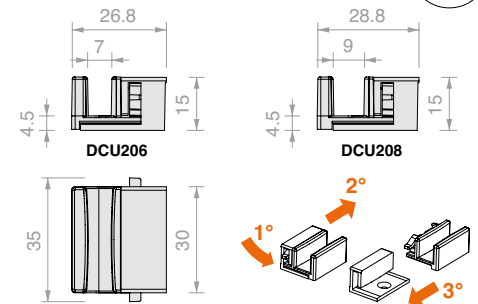

Art.	For glass	Qty
<b>DCU206</b>	6 mm	1 Pc
<b>DCU208</b>	8 mm	1 Pc



**FLOOR GUIDE FOR SEALED GLASS AND DRIP FLAP**

Material: ABS

Finish: /6 /88 /91 /97

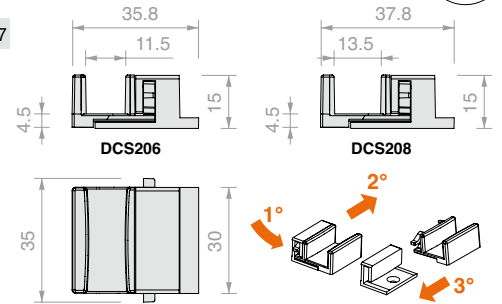

Art.	For glass	Qty
<b>DCS206</b>	6 mm	1 Pc
<b>DCS208</b>	8 mm	1 Pc



**GASKET WITH DRIP FLAP**

Material: Rigid PVC

Colour: transparent

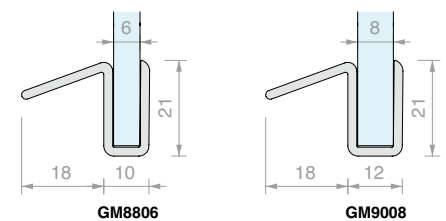

Art.	Length	For glass	Qty
<b>GM880607</b>	750 mm	6 mm	1 Pc
<b>GM880615</b>	1500 mm	6 mm	1 Pc
<b>GM900807</b>	750 mm	8 mm	1 Pc
<b>GM900815</b>	1500 mm	8 mm	1 Pc



**CORNER JOINT FOR PROFILE**

Material: Zamak  
 Compatible with aluminium profiles in the PBD and LMU series  
 For PBD3184 upper profile  
 Finish: /1 /6 /24 /97

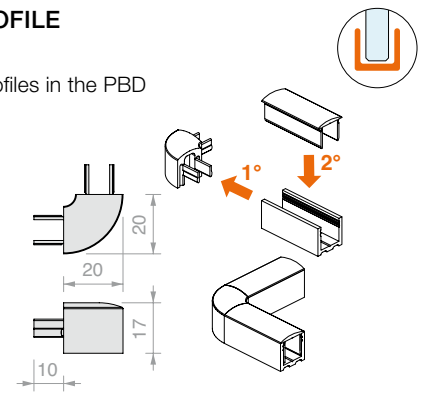

Art.	Qty
<b>DCC90</b>	1 Pc



**FLAT CORNER JOINT FOR PROFILE**

Material: Zamak  
 Compatible with aluminium profiles in the PBD and LMU series  
 For PBD3186 upper profile  
 Finish: /1 /6 /24 /97

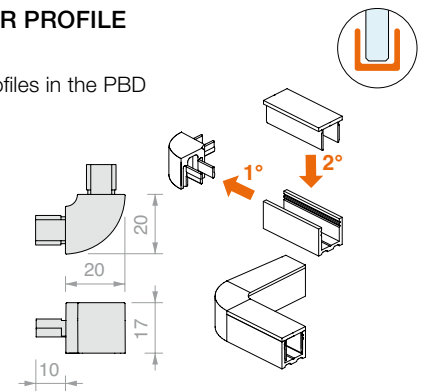

Art.	Qty
<b>DCC90SQ</b>	1 Pc



**CORNER JOINT FOR PESQ WATER BARRIER PROFILE**

Material: PPA  
 Finish: /88 /91 /97 /R2

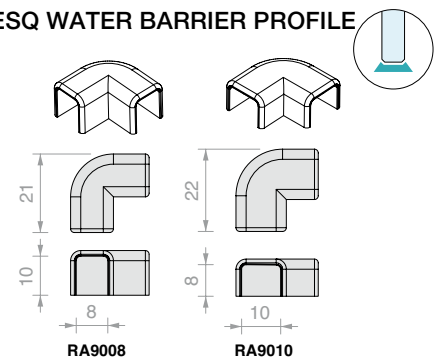

Art.	For glass	Qty
<b>RA9008</b>	From 6 to 8 mm	1 Pc
<b>RA9010</b>	10 mm	1 Pc



**HALF ROUND ADHESIVE PROTECTORS**

Material: Polyurethane, self-adhesive, acrylic quick-setting glue.  
 Resistant to UV rays, does not turn yellow  
 Colour: transparent

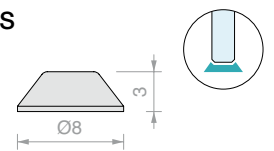

Art.	Pcs per sheet	Hardness	Qty
<b>GOC009</b>	288	66-70 Shore A	1 Pc



**PLASTIC SHIMS 10 x 30**

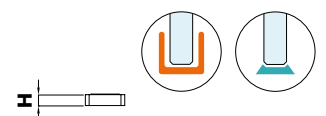

Art.	H	Package	Colour	Qty
<b>SPE2392</b>	2 mm	≈ 1200 Pcs	Red	1 kg
<b>SPE2393</b>	3 mm	≈ 1000 Pcs	Yellow	1 kg
<b>SPE2394</b>	4 mm	≈ 600 Pcs	Black	1 kg
<b>SPE2395</b>	5 mm	≈ 500 Pcs	White	1 kg
<b>SPE2397</b>	7 mm	≈ 400 Pcs	Green	1 kg

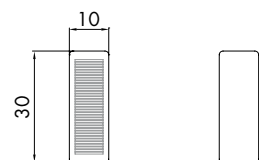



**MAN500V150 ADHESIVE HANDLE**

Material: Aluminium  
 Finish: /88 /91 /97 /R2

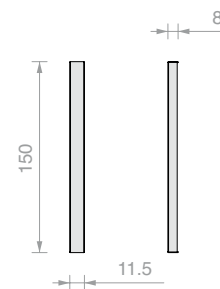

Art. **MAN500V150** Qty 1 Pc



**HAND6640VHB ADHESIVE HANDLE**

Material: Aluminium  
 Finish: /1 /6 /88 /91 /97

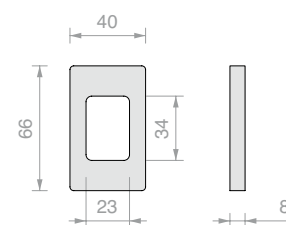

Art. **HAND6640VHB** Qty 1 Pc



**HAND10052VHB ADHESIVE HANDLE**

Material: Aluminium  
 Finish: /1 /6 /88 /91 /97

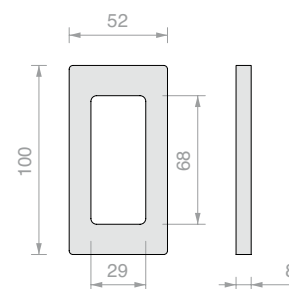

Art. **HAND10052VHB** Qty 1 Pc



**HAND13040VHB ADHESIVE HANDLE**

Material: Aluminium  
 Finish: /1 /6 /88 /91 /97

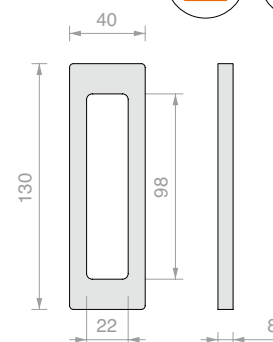

Art. **HAND13040VHB** Qty 1 Pc

# GOCCIA 50

## *Design*

Aluminium shower system for 8- and 10-mm glass with a max. load of 40 kg. Finished track and aluminium cover, with no visible components.

Complete kits for each kind of installation, with SOFTBREAK shock absorber included. Practical, functional and resistant.



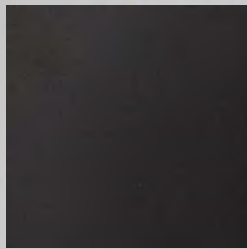

**/6**  
Matt Black



**/88**  
Brushed steel effect  
aluminium

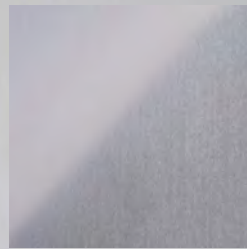

**/91**  
Polished aluminium

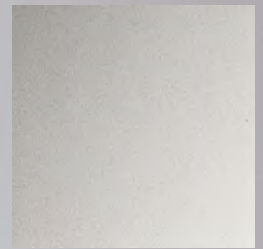

**/97**  
Matt aluminium

# GOCCIA 50

## Technical properties

Aluminium load-bearing profile, 68 mm x 54 mm adapted to various needs. The sliding door can weigh up to 40 kg, and the distance between the fixed panes and moving doors is just 13 mm. In addition, the quick-release rail at the floor simplifies cleaning. The dual Softbreak damper system, with a stopping distance of 60 mm, ensures safe and reliable opening and closing over time.

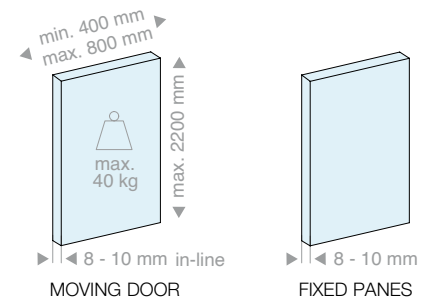

### 5 configurations

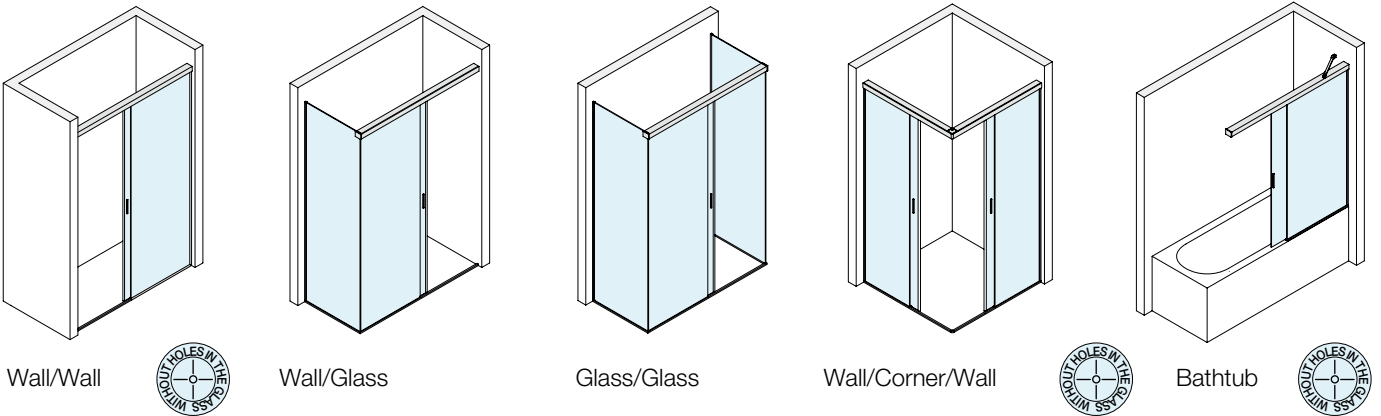

### 2 types of installation

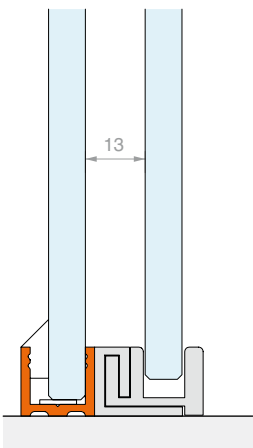
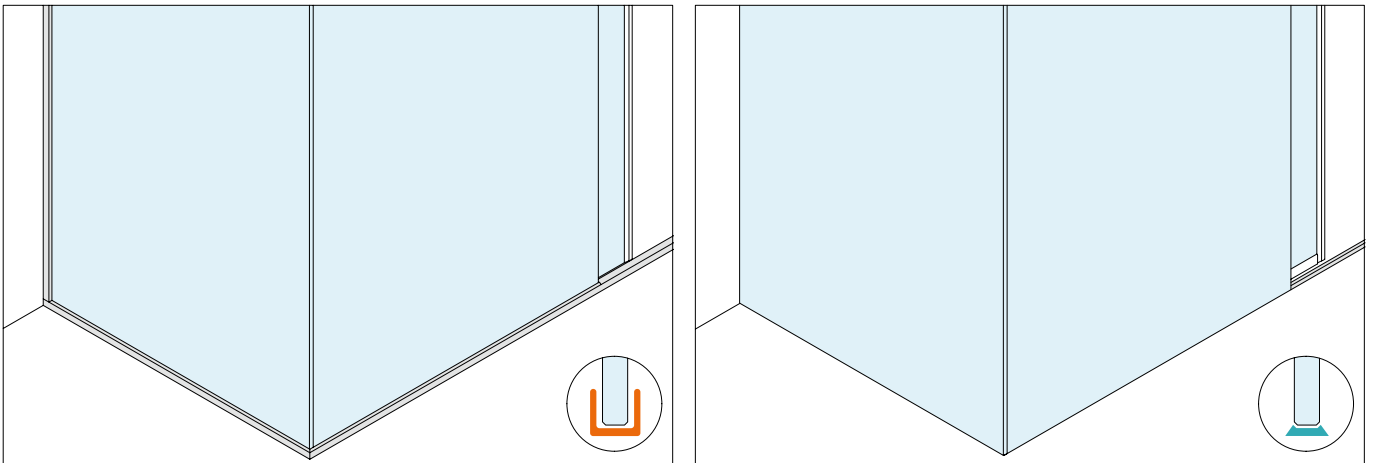

#### Linea U For framed fixed panes

Simple, modern design. With Linea U, fixed panes are held within a 15 mm x 16 mm aluminium profile. The same profile, with an upper snap-on cover, acts as a water barrier in the open area.

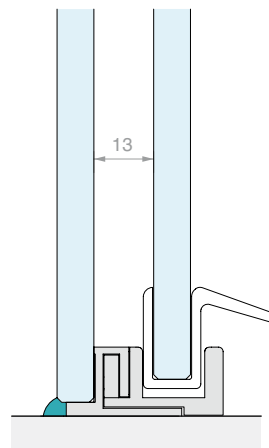

#### Linea S For sealed fixed panes

Elegance and perfect transparency. With Linea S, fixed panes are sealed to the supporting surface. A space-saving water barrier profile in aluminium, 8 mm x 10 mm, can be installed at the opening.



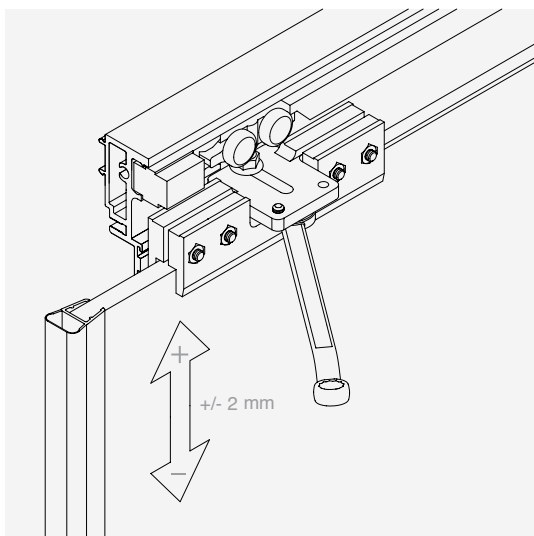

**DOOR ADJUSTMENT**

The height of each carrier can be adjusted to regulate the position of the door.

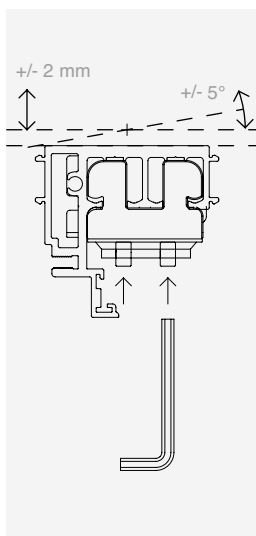

**TRACK ADJUSTMENT**

Vertical and angular adjustments allow the track to adapt perfectly to all types of needs.

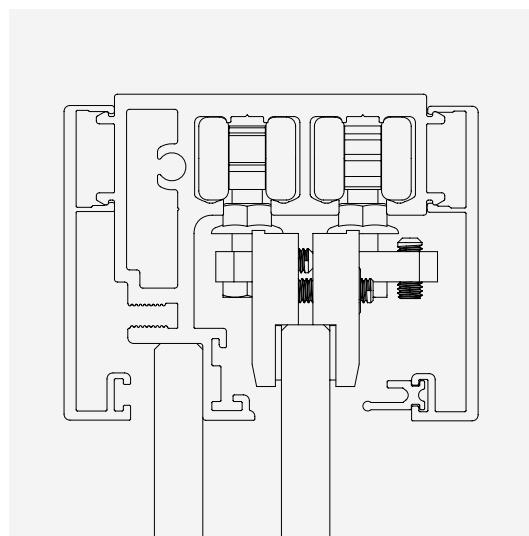

**CARRIER**

The carrier has four wheels to guarantee the utmost stability when the doors are sliding.

**SOFT BREAK**

The use of dampers reduces the speed of the door, attenuating impacts and allowing for controlled, noise-free movement.

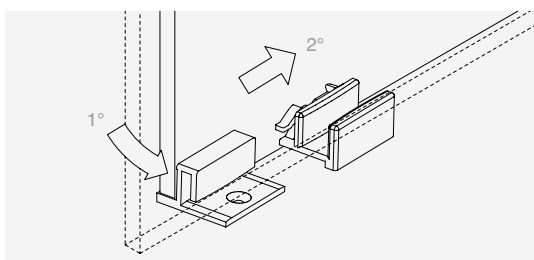
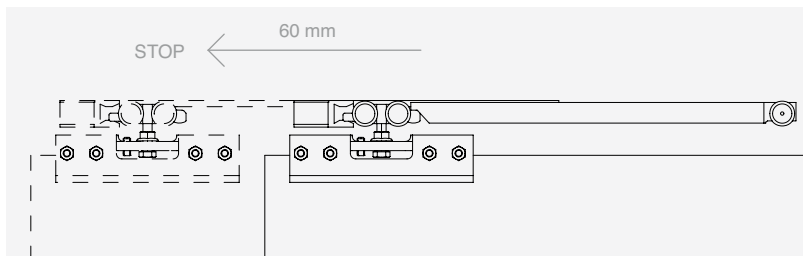

**CLEANING**

The sliding door can be detached with PUSH & UNLOCK functionality

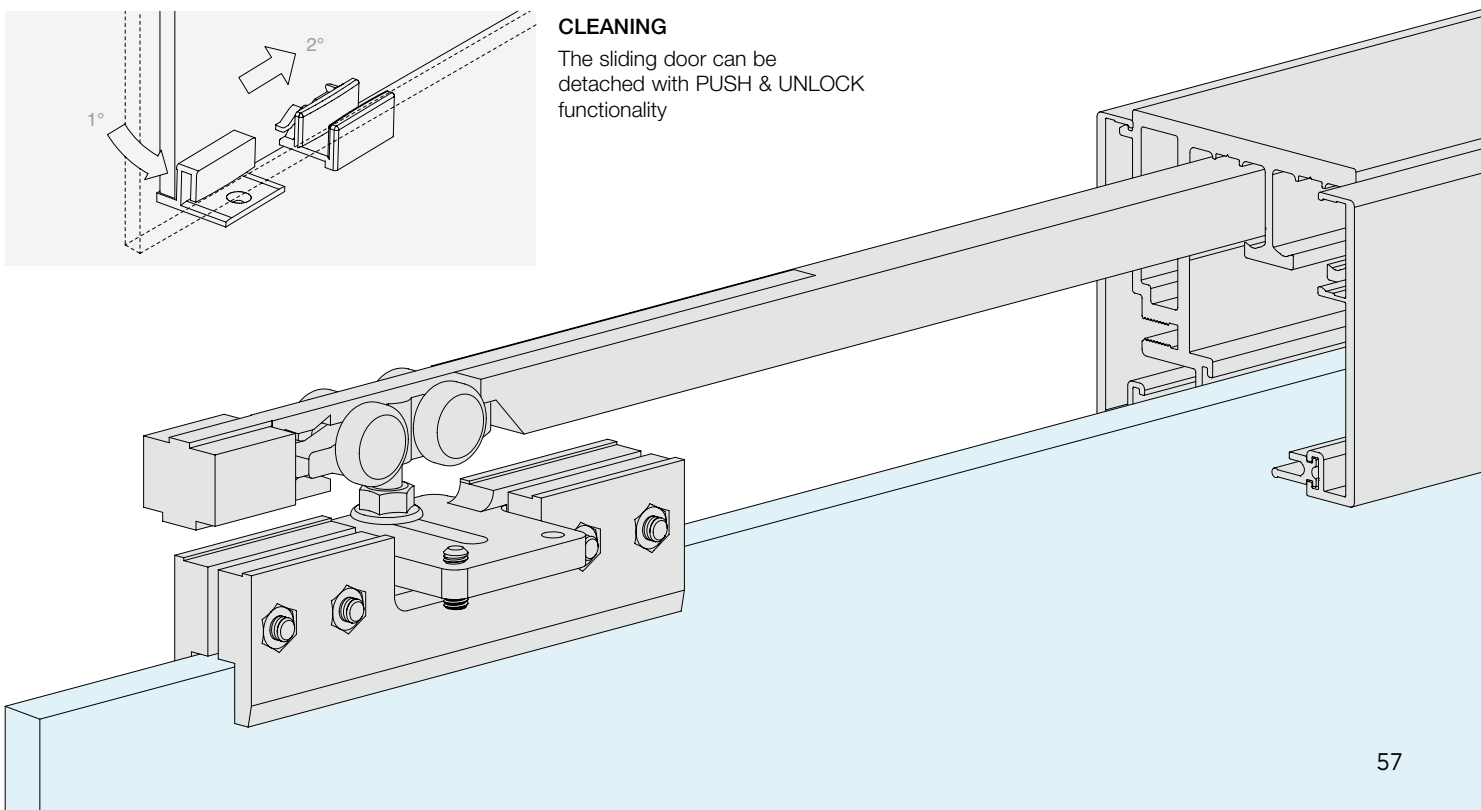



# GOCCIA 50

*Kit*



## CONFIGURATIONS WITH FRAMED FIXED PANES

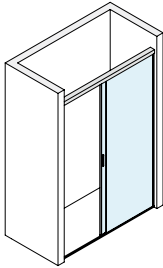

Page 61

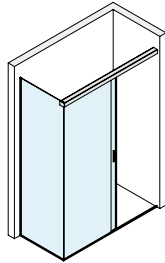

Page 63

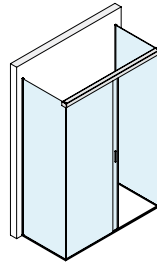

Page 65

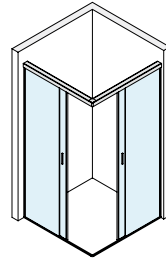

Page 67

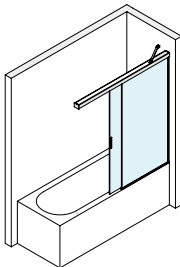

Page 69

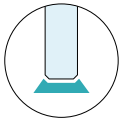

## CONFIGURATIONS WITH SEALED FIXED PANES

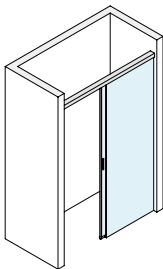

Page 70

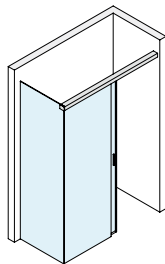

Page 72

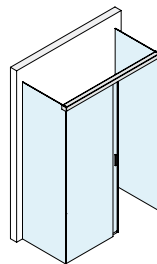

Page 74

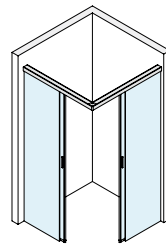

Page 76

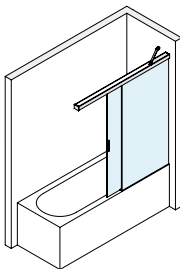

Page 78





**WALL/WALL SLIDING DOOR SHOWER KIT WITH FRAME PROFILE FOR FIXED PANE**

Finish: /6 /88 /91 /97

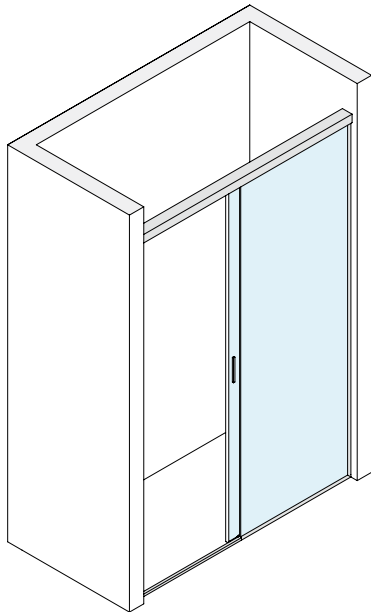

Kit comprising:

Art.	Description	Qty
<b>G50KIT02</b>	Fixed glass installation kit	1 Pc
<b>G50KIT03</b>	Wall fixing kit	2 Pcs
<b>G50KIT01</b>	Gripper and damper kit	2 Pcs
<b>DCU108SCT</b>	Snap-on floor guide	1 Pc
<b>MAN500V150</b>	Adhesive handle	2 Pcs
<b>LM5859.150</b>	Track	1 Pc
<b>057.3078.002</b>	Gasket for cover	3 m
<b>LM0859.150</b>	Cover	2 Pcs
<b>GM0622</b>	Balloon gasket	1 Pc
<b>GM0141022</b>	Gasket with side lip	1 Pc
<b>PBD3184.100</b>	Rounded upper profile	1 Pc
<b>PBD3183.220</b>	U-shaped profile	1 Pc
<b>PBD3183.150</b>	U-shaped profile	1 Pc
<b>GTUP4</b>	Glass holder gasket	5 m

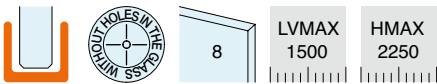
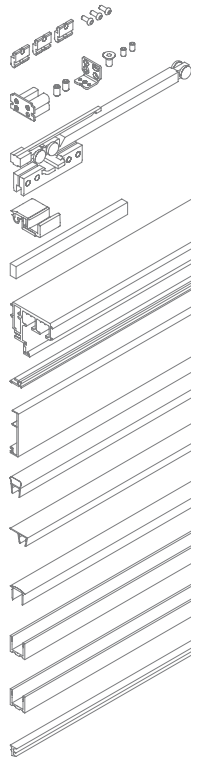

RECOMMENDED LAYOUTS

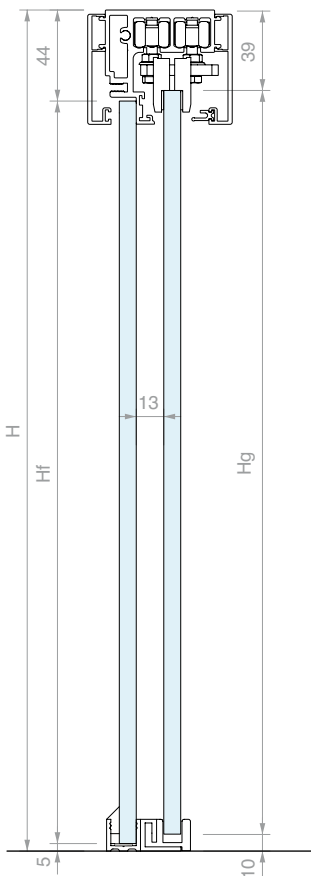

GLASS PANE DIMENSIONS

$L_g = (LV + 32) / 2$   
 $L_f = L_g$

$H_g = H - 49$   
 $H_f = H_g$

Other measurements  
 $LA = (LV - 148) / 2$

CLOSED SLIDING DOOR CONFIGURATION

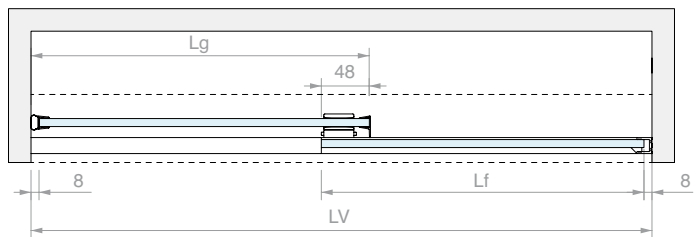

OPEN SLIDING DOOR CONFIGURATION

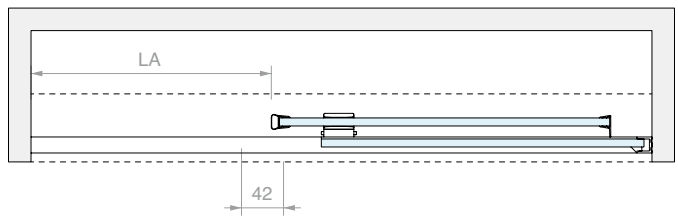

PRIMARY LENGTHS (mm)

LV	Lg	Lf	LA
1500	766	766	676
1400	716	716	626
1300	666	666	576
1200	616	616	526
1100	566	566	476

Art.  
**G50U10**

Qty  
1 Pc





**WALL/GLASS SLIDING DOOR SHOWER KIT WITH FRAME PROFILE FOR FIXED PANES**

Finish: /6 /88 /91 /97

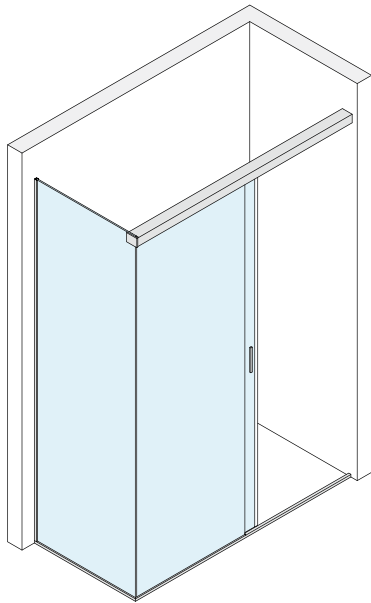

Kit comprising:

Art.	Description	Qty
<b>G50KIT02</b>	Fixed glass installation kit	1 Pc
<b>G50KIT04</b>	Glass fixing kit	1 Pc
<b>G50KIT03</b>	Wall fixing kit	1 Pc
<b>G50KIT01</b>	Gripper and damper kit	2 Pcs
<b>DCU108SCT</b>	Snap-on floor guide	1 Pc
<b>MAN500V150</b>	Adhesive handle	2 Pcs
<b>LM5859.150</b>	Track	1 Pc
<b>057.3078.002</b>	Gasket for cover	3 m
<b>LM0859.150</b>	Cover	2 Pcs
<b>GM0622</b>	Balloon gasket	1 Pc
<b>GM0141022</b>	Gasket with side lip	1 Pc
<b>PBD3184.100</b>	Rounded upper profile	1 Pc
<b>PBD3183.220</b>	U-shaped profile	1 Pc
<b>PBD3183.150</b>	U-shaped profile	2 Pcs
<b>GTUP4</b>	Glass holder gasket	6 m

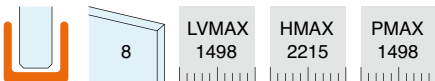
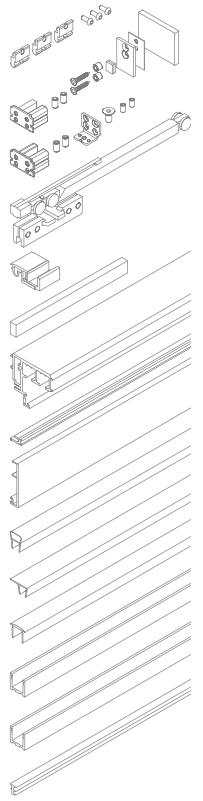

RECOMMENDED LAYOUTS

NOTCH FIXED SIDE GLASS

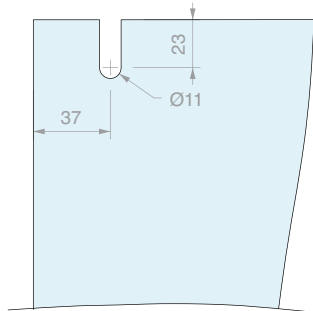
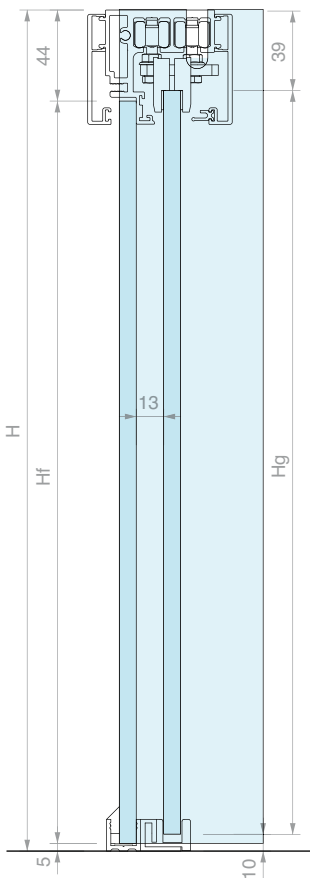

GLASS PANE DIMENSIONS

$L_g = (LV + 24) / 2$   
 $L_f = L_g$   
 $H_g = H - 49$   
 $H_f = H_g$   
 $L_i = P - 14$   
 $H_i = H - 5$   
 $L_A = (LV - 156) / 2$

CLOSED SLIDING DOOR CONFIGURATION

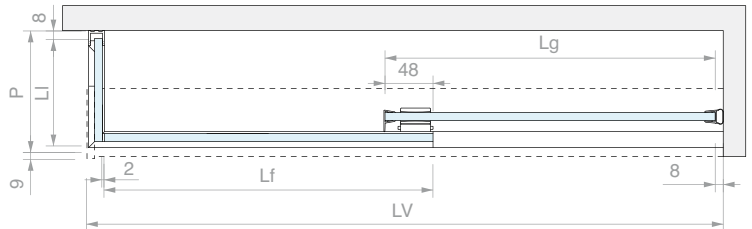

OPEN SLIDING DOOR CONFIGURATION

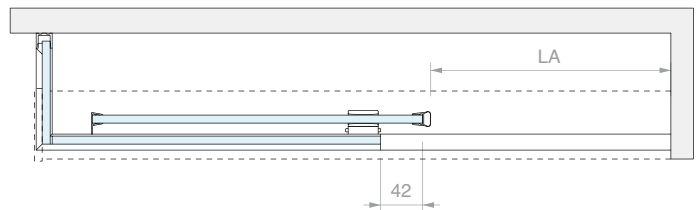

PRIMARY LENGTHS (mm)

LV	Lg	Lf	LA
1498	761	761	671
1398	711	711	621
1298	661	661	571
1198	611	611	521
1098	561	561	471

Art. **G50U20**

Qty  
1 Pc







**GLASS/GLASS SLIDING DOOR SHOWER KIT WITH FRAME PROFILE FOR FIXED PANES**

Finish: /6 /88 /91 /97

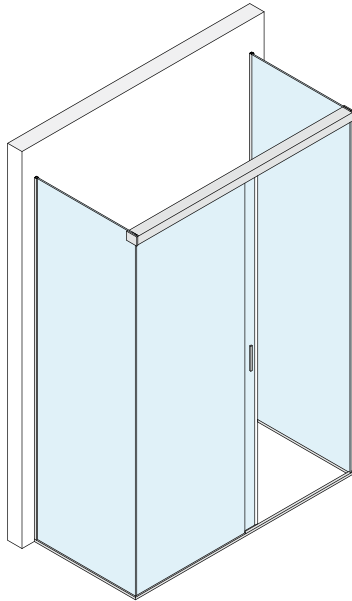

Kit comprising:

Art.	Description	Qty
<b>G50KIT02</b>	Fixed glass installation kit	1 Pc
<b>G50KIT04</b>	Glass fixing kit	2 Pcs
<b>G50KIT01</b>	Gripper and damper kit	2 Pcs
<b>DCU108SCT</b>	Snap-on floor guide	1 Pc
<b>MAN500V150</b>	Adhesive handle	2 Pcs
<b>LM5859.150</b>	Track	1 Pc
<b>057.3078.002</b>	Gasket for cover	3 m
<b>LM0859.150</b>	Cover	2 Pcs
<b>GM0622</b>	Balloon gasket	1 Pc
<b>GM0141022</b>	Gasket with side lip	1 Pc
<b>PBD3184.100</b>	Rounded upper profile	1 Pc
<b>PBD3183.220</b>	U-shaped profile	3 Pcs
<b>PBD3183.150</b>	U-shaped profile	1 Pc
<b>GTUP4</b>	Glass holder gasket	9 m

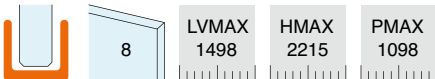
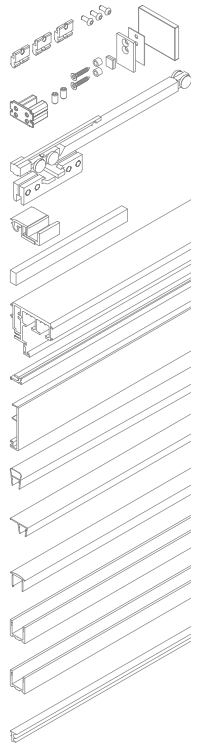

RECOMMENDED LAYOUTS

NOTCH FIXED SIDE GLASS

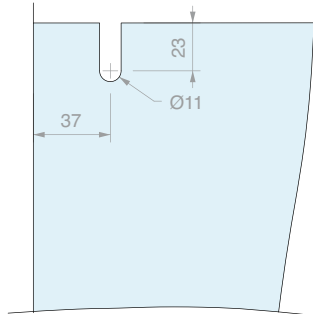
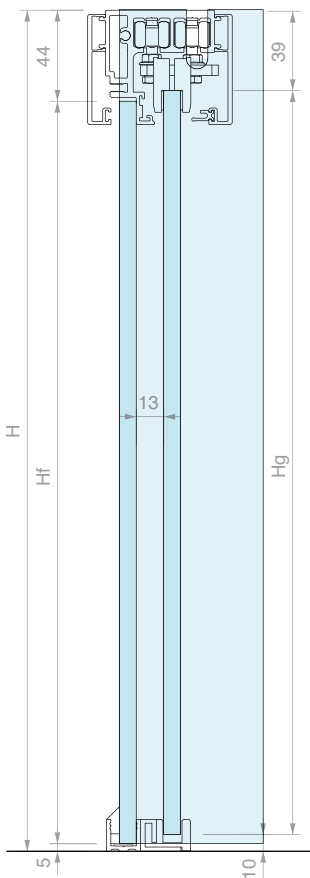

GLASS PANE DIMENSIONS

$L_g = (LV + 10) / 2$   
 $L_f = L_g$

$H_g = H - 49$   
 $H_f = H_g$

$L_i = P - 14$   
 $H_i = H - 5$

Other measurements

$LA = (LV - 170) / 2$

CLOSED SLIDING DOOR CONFIGURATION

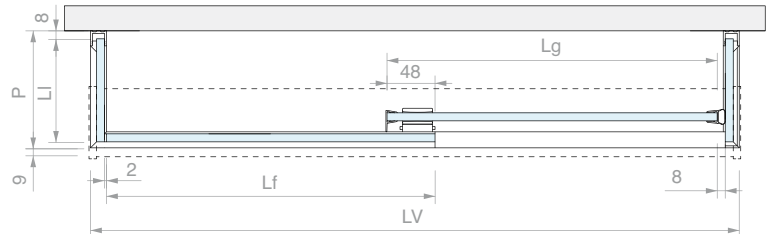

OPEN SLIDING DOOR CONFIGURATION

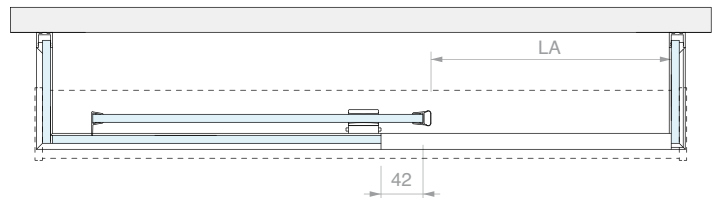

PRIMARY LENGTHS (mm)

LV	Lg	Lf	LA
1498	754	754	664
1398	704	704	614
1298	654	654	564
1198	604	604	514
1098	554	554	464

Art.  
**G50U30**

Qty  
1 Pc





**WALL/CORNER/WALL SLIDING DOOR SHOWER KIT WITH FRAME PROFILE FOR FIXED PANES**

Finish: /6 /88 /91 /97

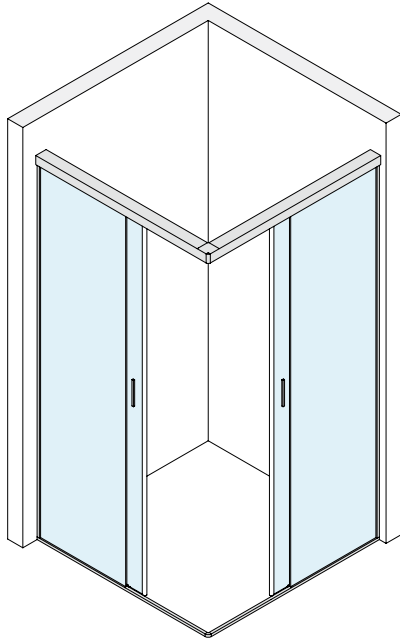

Kit comprising:

Art.	Description	Qty
<b>G50KIT02</b>	Fixed glass installation kit	2 Pcs
<b>G50KIT05</b>	Corner junction kit	1 Pc
<b>G50KIT03</b>	Wall fixing kit	2 Pcs
<b>G50KIT01</b>	Gripper and damper kit	4 Pcs
<b>DCU108SCT</b>	Snap-on floor guide	2 Pcs
<b>MAN500V150</b>	Adhesive handle	4 Pcs
<b>LM5859.100</b>	Track	2 Pcs
<b>057.3078.002</b>	Gasket for cover	6 m
<b>LM0859.100</b>	Cover	4 Pcs
<b>GM1520SX</b>	45° magnetic gasket	1 Pc
<b>GM1520SX</b>	45° magnetic gasket	1 Pc
<b>GM0141022</b>	Gasket with side lip	2 Pcs
<b>PBD3184.100</b>	Rounded upper profile	2 Pcs
<b>PBD3183.220</b>	U-shaped profile	2 Pcs
<b>PBD3183.150</b>	U-shaped profile	2 Pcs
<b>GTUP4</b>	Glass holder gasket	8 m
<b>DCC90</b>	Corner junction	1 Pc

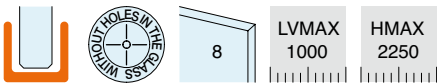
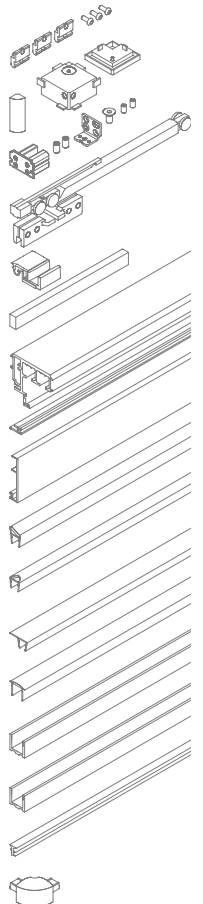

RECOMMENDED LAYOUTS

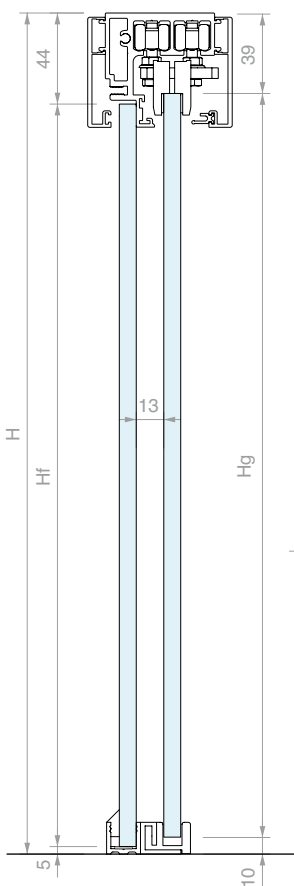

CLOSED SLIDING DOOR CONFIGURATION

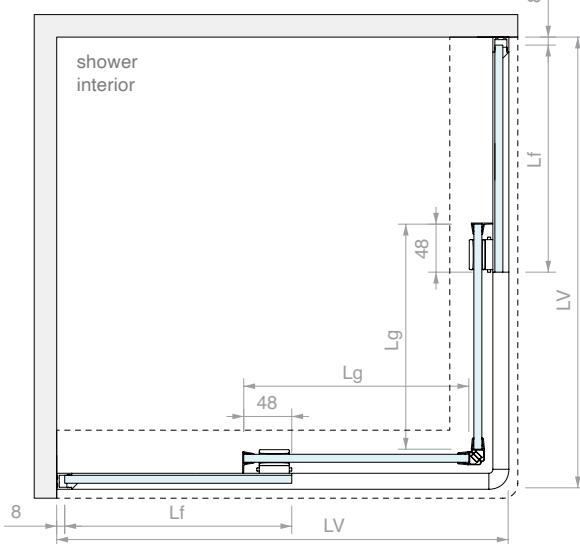

OPEN SLIDING DOOR CONFIGURATION

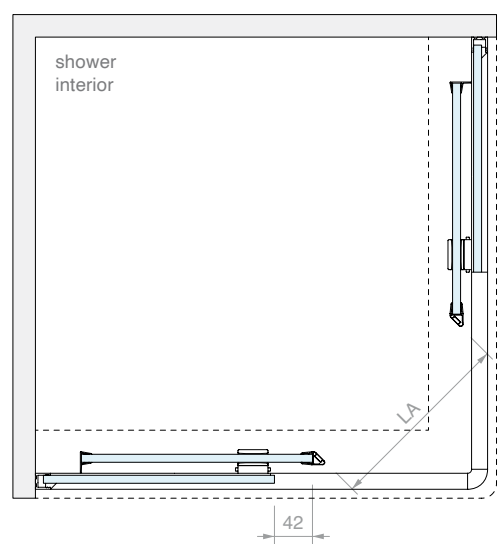

GLASS PANE DIMENSIONS

$L_g = LV / 2$   
 $L_f = L_g$   
 $H_g = H - 49$   
 $H_f = H_g$

Other measurements  
 $LA = 0.7 \times (LV - 168)$

PRIMARY LENGTHS (mm)

LV	Lg	Lf	LA
1000	500	500	582
900	450	450	512
800	400	400	442

Art.  
**G50U40**

Qty  
 1 Pc





**SLIDING DOOR SHOWER KIT FOR BATHTUB EDGE WITH FRAME PROFILE FOR FIXED PANE**

Finish: /6 /88 /91 /97

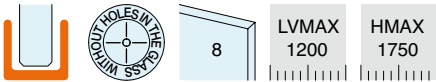
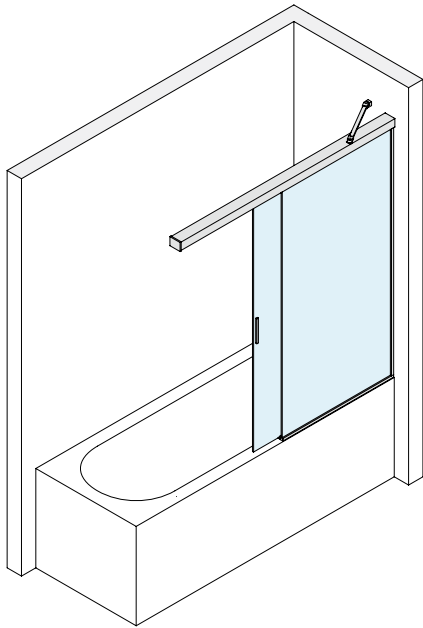

Kit comprising:

Art.	Description	Qty	
<b>G50KIT02</b>	Fixed glass installation kit	1 Pc	
<b>G50KIT06</b>	Cantilever fixing kit	1 Pc	
<b>G50KIT01</b>	Gripper and damper kit	2 Pcs	
<b>DCU108SCT</b>	Snap-on floor guide	1 Pc	
<b>MAN500V150</b>	Adhesive handle	2 Pcs	
<b>LM5859.150</b>	Track	1 Pc	
<b>057.3078.002</b>	Gasket for cover	3 m	
<b>LM0859.150</b>	Cover	2 Pcs	
<b>GM900807</b>	Gasket with drip flap	1 Pc	
<b>GM0141022</b>	Gasket with side lip	1 Pc	
<b>PBD3183.220</b>	U-shaped profile	1 Pc	
<b>PBD3183.150</b>	U-shaped profile	1 Pc	
<b>GTUP4</b>	Glass holder gasket	5 m	
<b>PBDTP</b>	Rounded cap	1 Pc	
<b>DQGKT01</b>	Stabilizer bar	1 Pc	

RECOMMENDED LAYOUTS

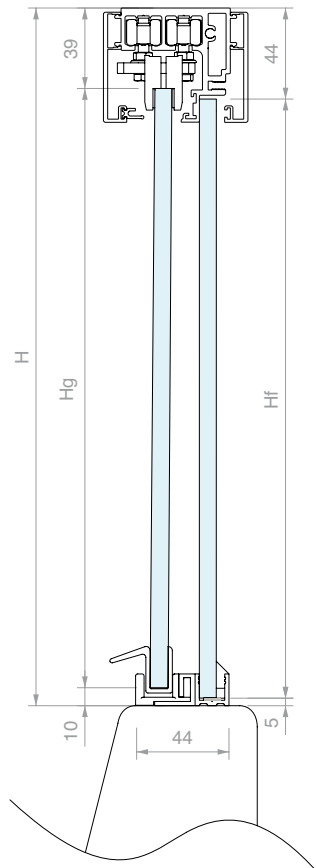

GLASS PANE DIMENSIONS

$L_g = (LV + 27) / 2$   
 $L_f = L_g$

$H_g = H - 49$   
 $H_f = H_g$

Other measurements  
 $LA = (LV - 128) / 2$

CLOSED SLIDING DOOR CONFIGURATION

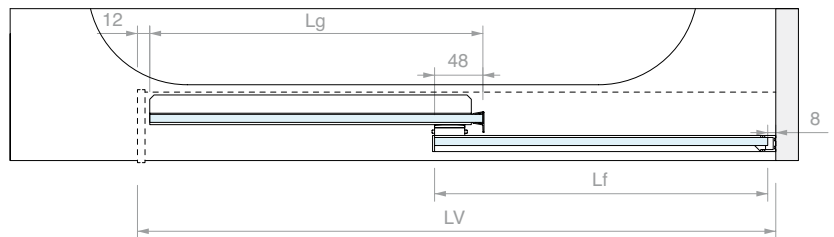

OPEN SLIDING DOOR CONFIGURATION

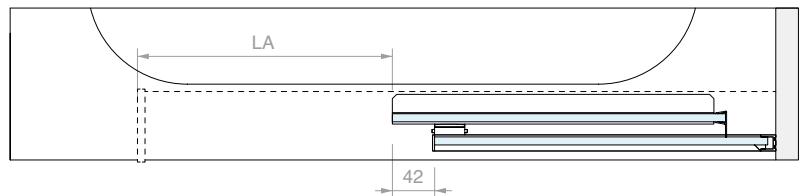

PRIMARY LENGTHS (mm)

LV	Lg	Lf	LA
1200	614	614	536
1100	564	564	486
1000	514	514	436

Art.  
**G50U50**

Qty  
1 Pc



WALL/WALL SLIDING DOOR SHOWER KIT FOR SEALED FIXED PANE

Finish: /6 /88 /91 /97

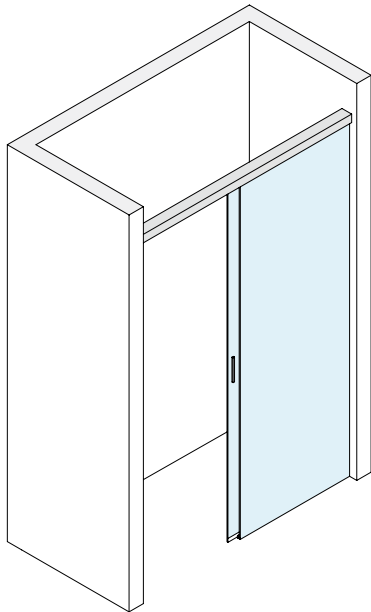

Kit comprising:

Art.	Description	Qty
<b>G50KIT02</b>	Fixed glass installation kit	1 Pc
<b>G50KIT03</b>	Wall fixing kit	2 Pcs
<b>G50KIT01</b>	Gripper and damper kit	2 Pcs
<b>DCS108</b>	Floor guide	1 Pc
<b>MAN500V150</b>	Adhesive handle	2 Pcs
<b>LM5859.150</b>	Track	1 Pc
<b>057.3078.002</b>	Seal for cover	3 m
<b>LM0859.150</b>	Cover	2 Pcs
<b>GM900807</b>	Gasket with drip flap	1 Pc
Optional		
<b>GM0622</b>	Balloon gasket	1 Pc
<b>GM0141022</b>	Gasket with side lip	1 Pc
<b>PESQ0810.075</b>	Water barrier profile	1 Pc

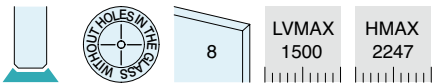

RECOMMENDED LAYOUTS

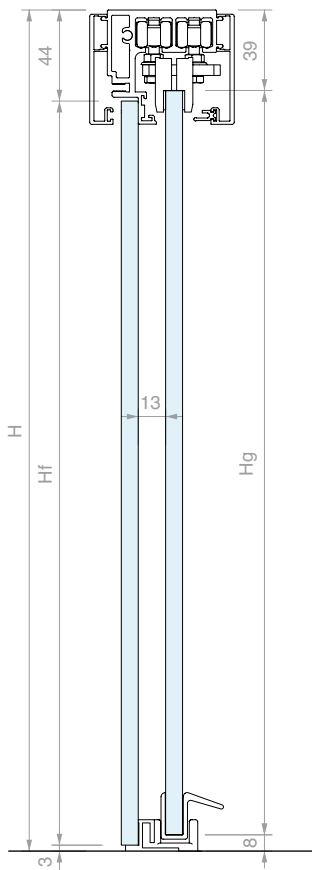

GLASS PANE DIMENSIONS

$L_g = (LV + 46) / 2$

$L_f = L_g$

$H_g = H - 47$

$H_f = H_g$

Other measurements

$LA = (LV - 142) / 2$

CLOSED SLIDING DOOR CONFIGURATION

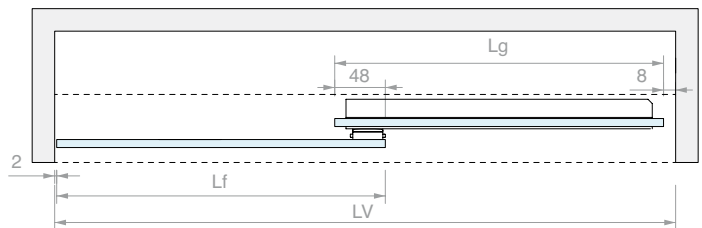

OPEN SLIDING DOOR CONFIGURATION

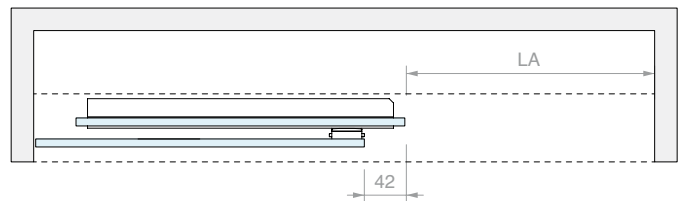

PRIMARY LENGTHS (mm)

LV	Lg	Lf	LA
1500	773	773	679
1400	723	723	629
1300	673	673	579
1200	623	623	529
1100	573	573	479

Art. **G50S10**

Qty **1 Pc**





**WALL/GLASS SLIDING DOOR SHOWER KIT FOR SEALED FIXED PANES**

Finish: /6 /88 /91 /97

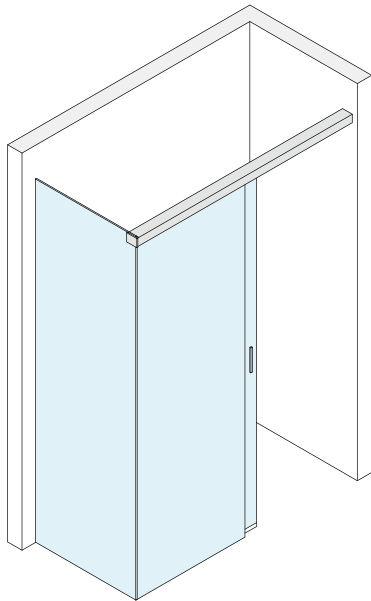

Kit comprising:

Art.	Description	Qty
<b>G50KIT02</b>	Fixed glass installation kit	1 Pc
<b>G50KIT04</b>	Glass fixing kit	1 Pc
<b>G50KIT03</b>	Wall fixing kit	1 Pc
<b>G50KIT01</b>	Gripper and damper kit	2 Pcs
<b>DCS108</b>	Floor guide	1 Pc
<b>MAN500V150</b>	Adhesive handle	2 Pcs
<b>LM5859.150</b>	Track	1 Pc
<b>057.3078.002</b>	Seal for cover	3 m
<b>LM0859.150</b>	Cover	2 Pcs
<b>GM900807</b>	Gasket with drip flap	1 Pc
Optional		
<b>GM0622</b>	Balloon gasket	1 Pc
<b>GM0141022</b>	Gasket with side lip	1 Pc
<b>PESQ0810.075</b>	Water barrier profile	1 Pc

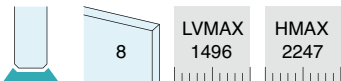
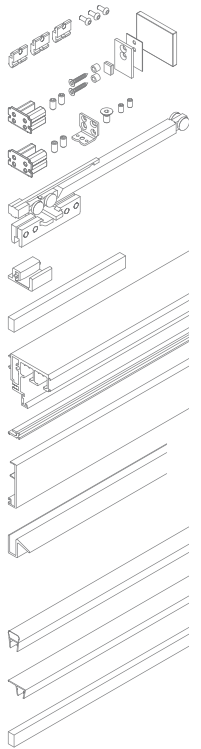

RECOMMENDED LAYOUTS

NOTCH FIXED SIDE GLASS

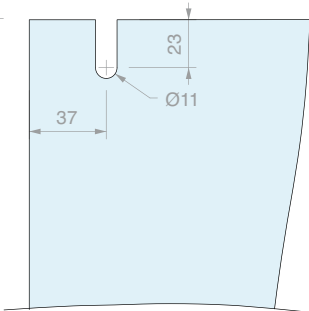
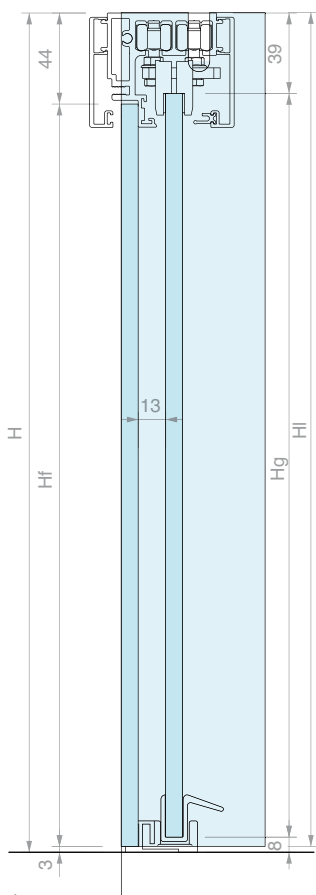

GLASS PANE DIMENSIONS

$L_g = (LV + 38) / 2$   
 $L_f = L_g$

$H_g = H - 47$   
 $H_f = H_g$

$L_i = P - 2$   
 $H_i = H - 3$

Other measurements  
 $LA = (LV - 150) / 2$

CLOSED SLIDING DOOR CONFIGURATION

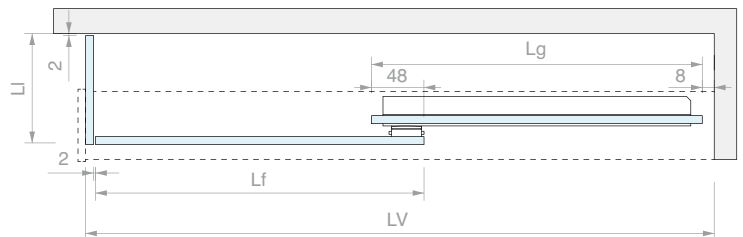

OPEN SLIDING DOOR CONFIGURATION

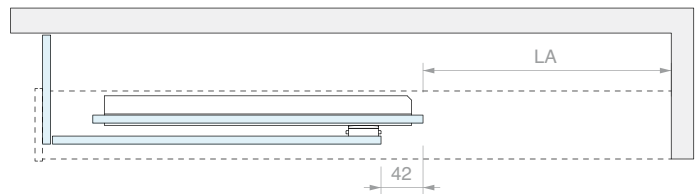

PRIMARY LENGTHS (mm)

LV	Lg	Lf	LA
1496	767	767	673
1396	717	717	623
1296	667	667	573
1196	617	617	523
1096	567	567	473

Art.  
**G50S20**

Qty  
1 Pc







GLASS/GLASS SLIDING DOOR SHOWER KIT FOR SEALED FIXED PANES

Finish: /6 /88 /91 /97

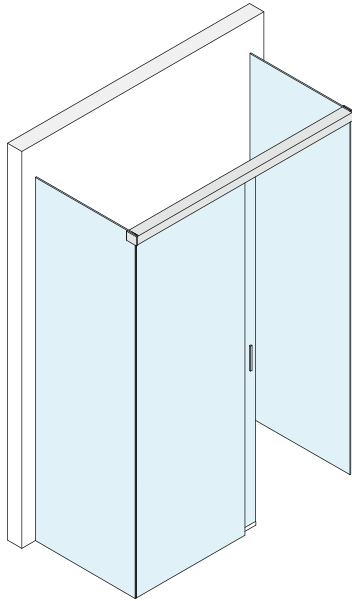

Kit comprising:

Art.	Description	Qty
<b>G50KIT02</b>	Fixed glass installation kit	1 Pc
<b>G50KIT04</b>	Glass fixing kit	2 Pcs
<b>G50KIT01</b>	Gripper and damper kit	2 Pcs
<b>DCS108</b>	Floor guide	1 Pc
<b>MAN500V150</b>	Adhesive handle	2 Pcs
<b>LM5859.150</b>	Track	1 Pc
<b>057.3078.002</b>	Seal for cover	3 m
<b>LM0859.150</b>	Cover	2 Pcs
<b>GM900807</b>	Gasket with drip flap	1 Pc
Optional		
<b>GM0622</b>	Balloon gasket	1 Pc
<b>GM0141022</b>	Gasket with side lip	1 Pc
<b>PESQ0810.075</b>	Water barrier profile	1 Pc

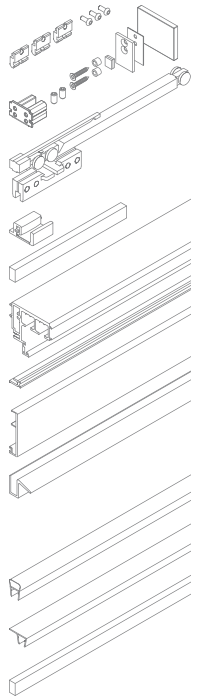

RECOMMENDED LAYOUTS

NOTCH FIXED SIDE GLASS

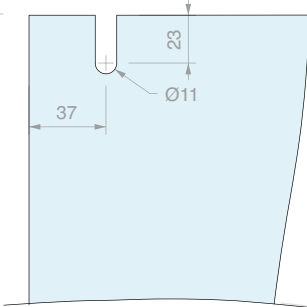
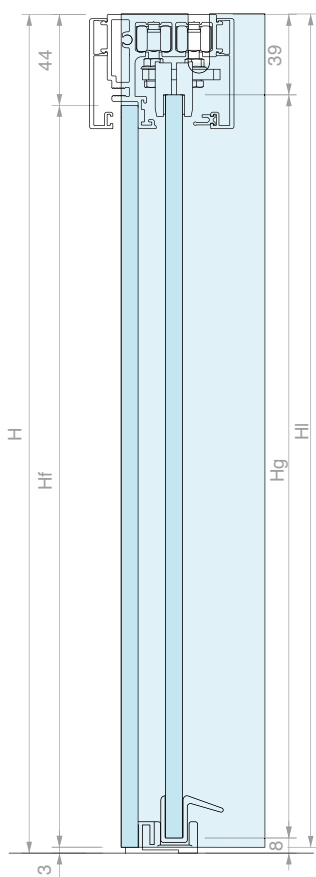

GLASS PANE DIMENSIONS

$L_g = (LV + 30) / 2$   
 $L_f = L_g$

$H_g = H - 47$   
 $H_f = H_g$

$L_i = P - 2$   
 $H_i = H - 3$

Other measurements  
 $LA = (LV - 158) / 2$

CLOSED SLIDING DOOR CONFIGURATION

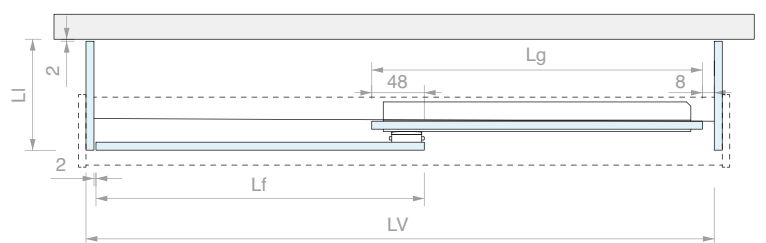

OPEN SLIDING DOOR CONFIGURATION

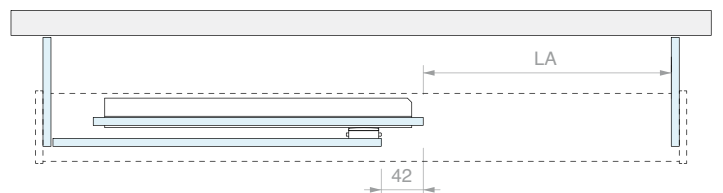

PRIMARY LENGTHS (mm)

LV	Lg	Lf	LA
1494	762	762	668
1394	712	712	618
1294	662	662	568
1194	612	612	518
1094	562	562	468

Art. **G50S30**

Qty **1 Pc**





WALL/CORNER/WALL SLIDING DOOR SHOWER KIT FOR SEALED FIXED PANES

Finish: /6 /88 /91 /97

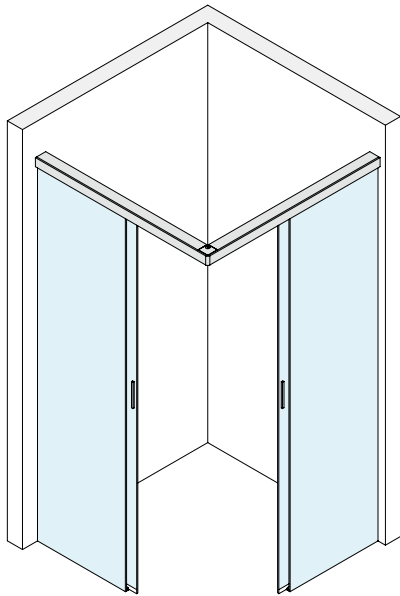

Kit comprising:

Art.	Description	Qty
<b>G50KIT02</b>	Fixed glass installation kit	2 Pcs
<b>G50KIT05</b>	Corner junction kit	1 Pc
<b>G50KIT03</b>	Wall fixing kit	2 Pcs
<b>G50KIT01</b>	Gripper and damper kit	4 Pcs
<b>DCS108</b>	Floor guide	2 Pcs
<b>MAN500V150</b>	Adhesive handle	4 Pcs
<b>LM5859.100</b>	Track	2 Pcs
<b>057.3078.002</b>	Seal for cover	6 m
<b>LM0859.100</b>	Cover	4 Pcs
<b>GM900807</b>	Gasket with drip flap	1 Pc
Optional		
<b>GM1520SX</b>	45° magnetic gasket	1 Pc
<b>GM1520DX</b>	45° magnetic gasket	1 Pc
<b>GM0141022</b>	Gasket with side lip	2 Pcs
<b>PESQ0810.075</b>	Water barrier profile	2 Pcs
<b>RA9008</b>	Corner joint for water barrier profile	1 Pc

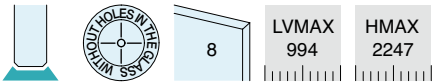

RECOMMENDED LAYOUTS

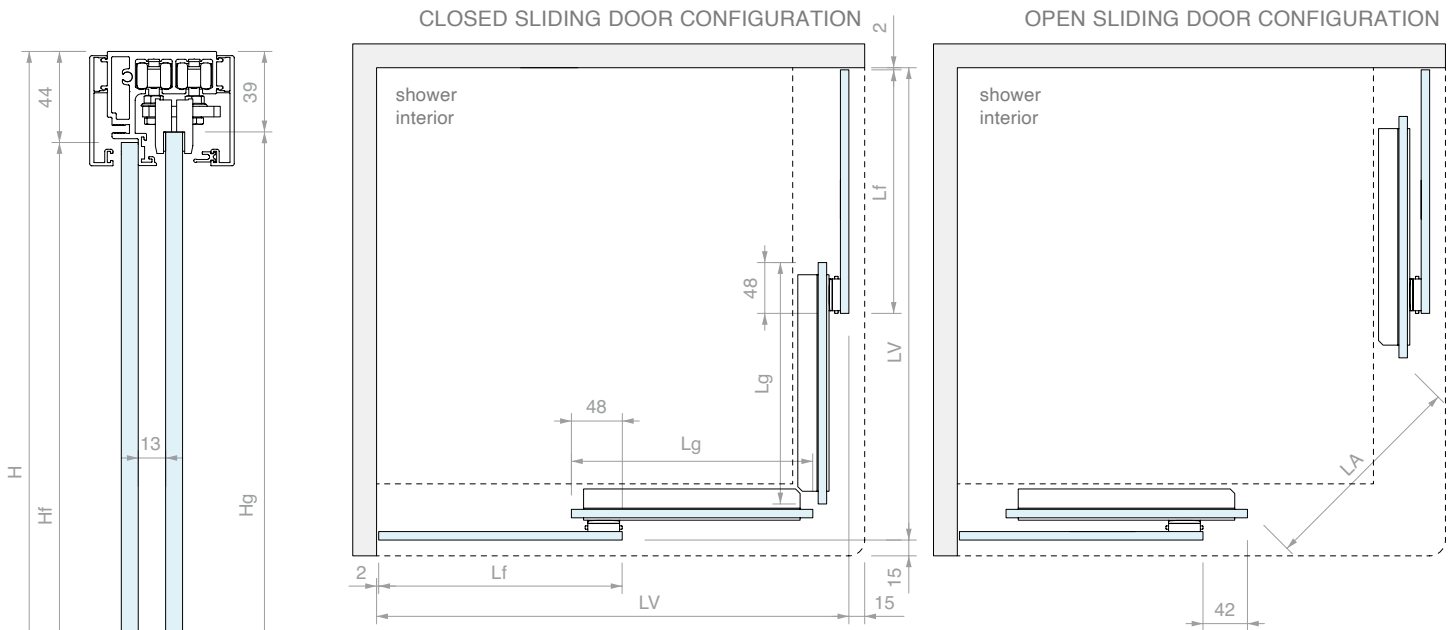

GLASS PANE DIMENSIONS

$Lg = (LV + 12) / 2$   
 $Lf = Lg$   
 $Hg = H - 47$   
 $Hf = Hg$

Other measurements  
 $LA = 0.7 \times (LV - 158)$

PRIMARY LENGTHS (mm)

LV	Lg	Lf	LA
994	503	503	585
894	453	453	515
794	403	403	445

Art.	<b>G50S40</b>	Qty	1 Pc
------	---------------	-----	------





SLIDING DOOR SHOWER KIT FOR BATHTUB EDGE FOR SEALED FIXED GLASS

Finish: /6 /88 /91 /97

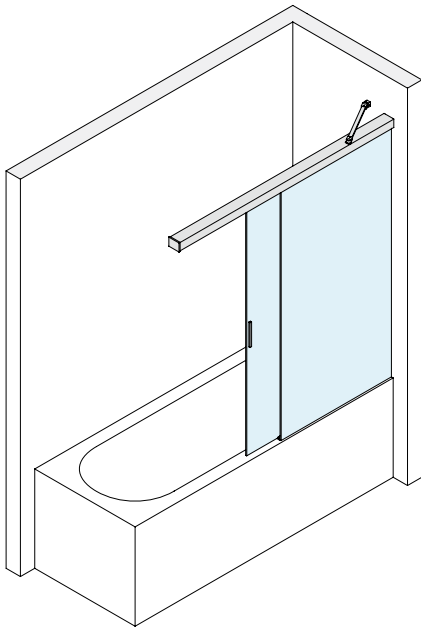

Kit comprising:

Art.	Description	Qty
<b>G50KIT02</b>	Fixed glass installation kit	1 Pc
<b>G50KIT06</b>	Cantilever fixing kit	1 Pc
<b>G50KIT01</b>	Gripper and damper kit	2 Pcs
<b>DCS108</b>	Floor guide	1 Pc
<b>MAN500V150</b>	Adhesive handle	2 Pcs
<b>LM5859.150</b>	Track	1 Pc
<b>057.3078.002</b>	Seal for cover	3 m
<b>LM0859.150</b>	Cover	2 Pcs
<b>GM900807</b>	Gasket with drip flap	1 Pc
<b>DQGKT01</b>	Stabilizer bar	1 Pc
Optional		
<b>GM0141022</b>	Gasket with side lip	1 Pc

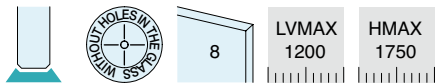
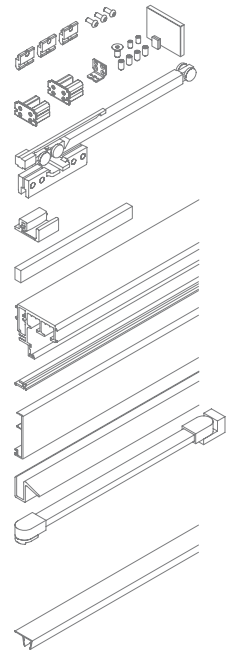

RECOMMENDED LAYOUTS

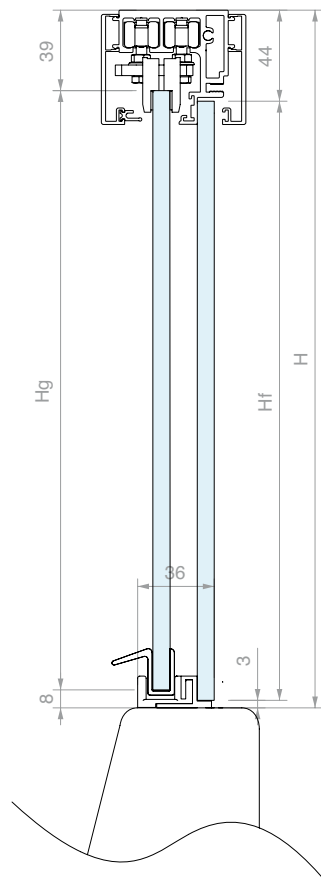

GLASS DIMENSIONS

$L_g = (LV + 34) / 2$   
 $L_f = L_g$

$H_g = H - 47$   
 $H_f = H_g$

Other measurements  
 $LA = (LV - 122) / 2$

CLOSED SLIDING DOOR CONFIGURATION

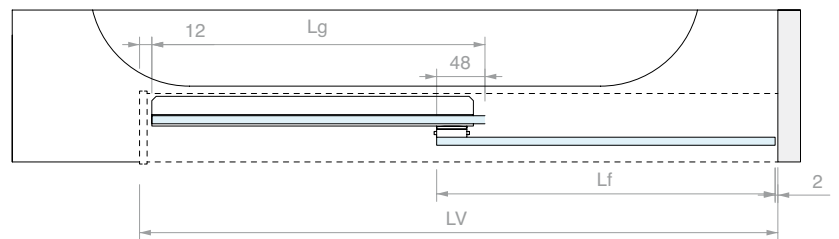

OPEN SLIDING DOOR CONFIGURATION

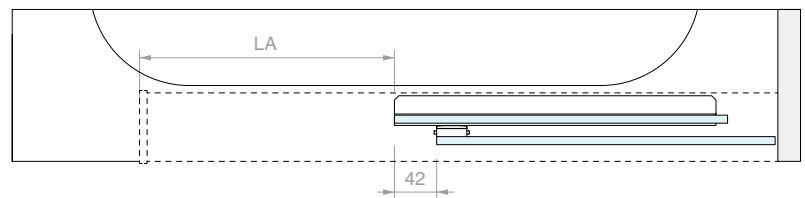

PRIMARY LENGTHS (mm)

LV	Lg	Lf	LA
1200	617	617	539
1100	567	567	489
1000	517	517	439

Art. **G50S50**

Qty  
1 Pc





G50U10	G50U20	G50U30	G50U40	G50U50	G50S10	G50S20	G50S30	G50S40	G50S50		
2 Pcs	2 Pcs	2 Pcs	4 Pcs	2 Pcs	2 Pcs	2 Pcs	2 Pcs	4 Pcs	2 Pcs	<b>G50KIT01</b>	○
1 Pc	1 Pc	1 Pc	2 Pcs	1 Pc	1 Pc	1 Pc	1 Pc	2 Pcs	1 Pc	<b>G50KIT02</b>	○
2 Pcs	1 Pc		2 Pcs		2 Pcs	1 Pc		2 Pcs		<b>G50KIT03</b>	○
	1 Pc	2 Pcs				1 Pc	2 Pcs			<b>G50KIT04</b>	○
			1 Pc					1 Pc		<b>G50KIT05</b>	○
				1 Pc					1 Pc	<b>G50KIT06</b>	○
2 Pcs	2 Pcs	2 Pcs	4 Pcs	2 Pcs	2 Pcs	2 Pcs	2 Pcs	4 Pcs	2 Pcs	<b>MAN500V150</b>	○
1 Pc	1 Pc	1 Pc	2 Pcs	1 Pc	1 Pc	1 Pc	1 Pc	2 Pcs	1 Pc	<b>LM5859.150</b> <b>LM5859.100</b>	○
3 m	3 m	3 m	6 m	3 m	3 m	3 m	3 m	6 m	3 m	<b>057.3078.002</b>	○
2 Pcs	2 Pcs	2 Pcs	4 Pcs	2 Pcs	2 Pcs	2 Pcs	2 Pcs	4 Pcs	2 Pcs	<b>LM0859.150</b> <b>LM0859.100</b>	○
1 Pc	1 Pc	1 Pc			1 Pc OPTIONAL	1 Pc OPTIONAL	1 Pc OPTIONAL			<b>GM0622</b>	○
			1 Pc					1 Pc OPTIONAL		<b>GM1520DX</b>	○
			1 Pc					1 Pc OPTIONAL		<b>GM1520SX</b>	○
1 Pc	1 Pc	1 Pc	2 Pcs	1 Pc	1 Pc OPTIONAL	1 Pc OPTIONAL	1 Pc OPTIONAL	2 Pcs OPTIONAL	1 Pc OPTIONAL	<b>GM0141022</b>	○
				1 Pc	1 Pc	1 Pc	1 Pc	2 Pcs	1 Pc	<b>GM900807</b> <b>GM921007</b>	○ ●
					1 Pc	1 Pc	1 Pc	2 Pcs	1 Pc	<b>DCS108</b> <b>DCS110</b>	○ ●
1 Pc	1 Pc	1 Pc	2 Pcs							<b>DCU108SCT</b> <b>DCU110SCT</b>	○ ●
				1 Pc						<b>DCV108</b> <b>DCV110</b>	○ ●
1 Pc	1 Pc	1 Pc	2 Pcs							<b>PBD3184.100</b>	○
1 Pc 1 Pc	1 Pc 2 Pcs	3 Pcs 1 Pc	2 Pcs 2 Pcs	1 Pc 1 Pc						<b>PBD3183.220</b> <b>PBD3183.150</b>	○ ○
5 m	6 m	9 m	8 m	5 m						<b>GTUP4</b> <b>GTUP2</b>	○ ●
				1 Pc						<b>PBDTP</b>	○
			1 Pc							<b>DCC90</b>	○
					1 Pc OPTIONAL	1 Pc OPTIONAL	1 Pc OPTIONAL	2 Pcs OPTIONAL		<b>PESQ0810.075</b>	○
								1 Pc OPTIONAL		<b>RA9008</b> <b>RA9010</b>	○ ●
				1 Pc					1 Pc	<b>DQGKT01</b>	○

- = Universal components
- = Components for 8-mm glass
- = Components for 10-mm glass

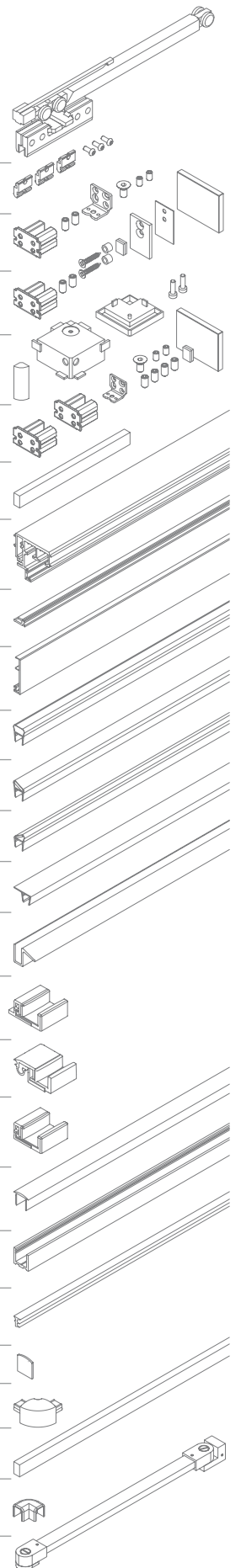





**MEASUREMENTS (mm):**

LV length at the floor

H total height

P depth at the floor (if applicable)

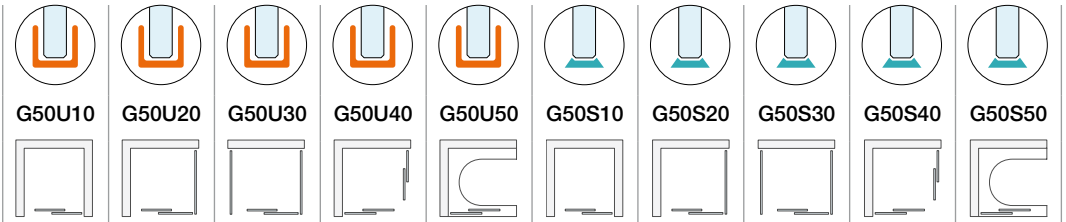

type of pane	dimension	pane thick-ness	G50U10	G50U20	G50U30	G50U40	G50U50	G50S10	G50S20	G50S30	G50S40	G50S50
			LV <sub>max</sub> = 1500 H <sub>max</sub> = 2247	LV <sub>max</sub> = 1498 H <sub>max</sub> = 2215 P <sub>max</sub> = 1498	LV <sub>max</sub> = 1498 H <sub>max</sub> = 2215 P <sub>max</sub> = 1098	LV <sub>max</sub> = 1000 H <sub>max</sub> = 2247	LV <sub>max</sub> = 1500 H <sub>max</sub> = 1750	LV <sub>max</sub> = 1500 H <sub>max</sub> = 2247	LV <sub>max</sub> = 1496 H <sub>max</sub> = 2247 P <sub>max</sub> = n/a	LV <sub>max</sub> = 1494 H <sub>max</sub> = 2247 P <sub>max</sub> = n/a	LV <sub>max</sub> = 994 H <sub>max</sub> = 2247	LV <sub>max</sub> = 1500 H <sub>max</sub> = 1750
moving door	width (Lg)	8-10 mm	$\frac{LV + 32}{2}$	$\frac{LV + 24}{2}$	$\frac{LV + 10}{2}$	$\frac{LV}{2}$	$\frac{LV + 28}{2}$	$\frac{LV + 38}{2}$	$\frac{LV + 30}{2}$	$\frac{LV + 22}{2}$	$\frac{LV + 12}{2}$	$\frac{LV + 34}{2}$
	height (Hg)	8-10 mm	H - 49	H - 49	H - 49	H - 49	H - 49	H - 47	H - 47	H - 47	H - 47	H - 47
fixed pane	width (Lf)	8-10 mm	$\frac{LV + 32}{2}$	$\frac{LV + 24}{2}$	$\frac{LV + 10}{2}$	$\frac{LV}{2}$	$\frac{LV + 28}{2}$	$\frac{LV + 38}{2}$	$\frac{LV + 30}{2}$	$\frac{LV + 22}{2}$	$\frac{LV + 12}{2}$	$\frac{LV + 34}{2}$
	height (Hf)	8-10 mm	H - 49	H - 49	H - 49	H - 49	H - 49	H - 47	H - 47	H - 47	H - 47	H - 47
fixed adjust-ment	width (Li)	8mm	-	P - 14	P - 14	-	-	-	P - 2	P - 2	-	-
		10mm	-	P - 12	P - 12	-	-	-	P - 2	P - 2	-	-
	height (Hi)	8-10 mm	-	H - 5	H - 5	-	-	-	H - 3	H - 3	-	-

**REFERENCE SIZES FOR THE DEPTH: (only for Wall/Glass and Glass/Glass configurations)**

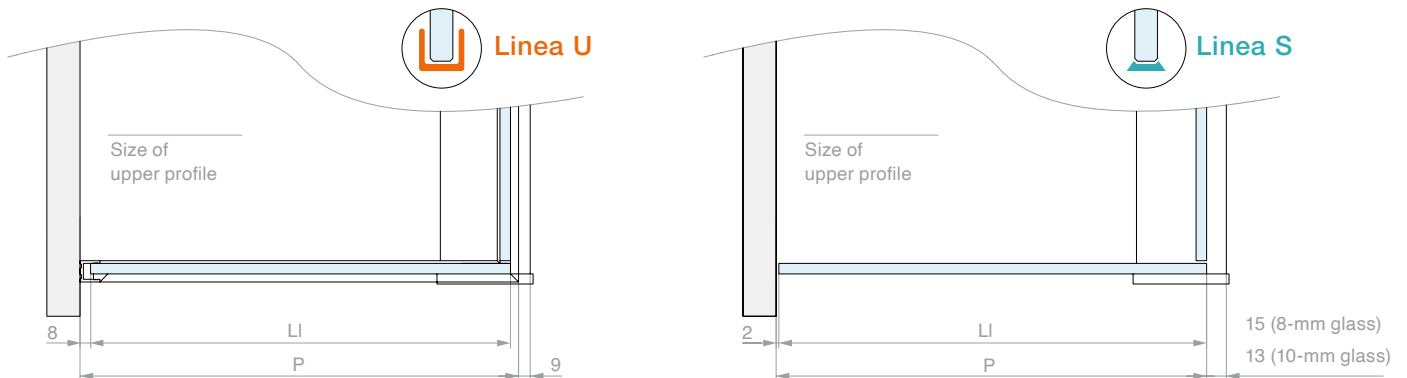

**SHAPE AND POSITION OF THE NOTCHES: (only for side panes in Wall/Glass and Glass/Glass configurations)**

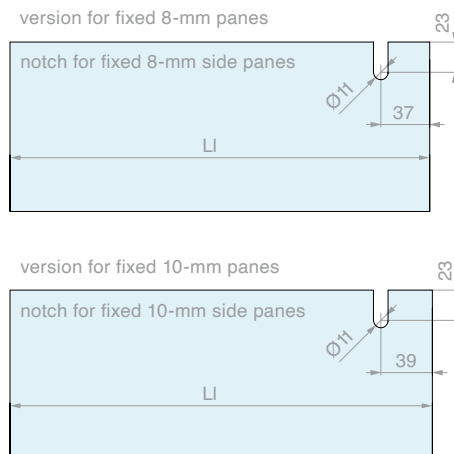

Note: Glass panes in moving doors and fixed front panes do not require processing in any configuration.



**GRIPPER AND DAMPER KIT**

composed of:

- 1 activator
- 1 carrier with damper
- 1 complete gripper
- 1 screw for carrier
- 1 lock nut for carrier screws
- 1 anti-derailment device

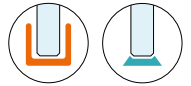

Art.	For glass	Qty
<b>G50KIT01</b>	From 8 to 10 mm	1 Pc



**FIXED GLASS INSTALLATION KIT**

composed of:

- 3 reversible plastic inserts
- 3 M4x10 mm round head screws

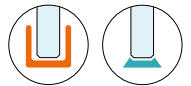

Art.	For glass	Qty
<b>G50KIT02</b>	From 8 to 10 mm	1 Pc



**WALL FIXING KIT**

composed of:

- 1 POM plastic insert
- 2 M6x12 mm set screws
- 1 wall fixing bracket 27 mm x 38 mm h 33 mm
- 1 M6x12 mm countersunk screw
- 2 M5x8 mm adjustment set screws

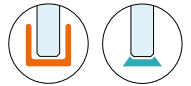

Art.	Qty
<b>G50KIT03</b>	1 Pc



**GLASS FIXING KIT**

composed of:

- 1 POM insert
- 2 M6x12 mm set screws
- 2 5.5 mm x 32 mm self-tapping screws
- 2 cylindrical gaskets to protect the notch
- 1 flat seal between the glass and counterplate
- 1 steel counterplate
- 1 fixing cover, 3M Dual Lock 40 mm x 19 mm x 5.7 mm
- 1 aluminium finishing cover

Finish: /6 /88 /91 /97



Art.	Qty
<b>G50KIT04</b>	1 Pc

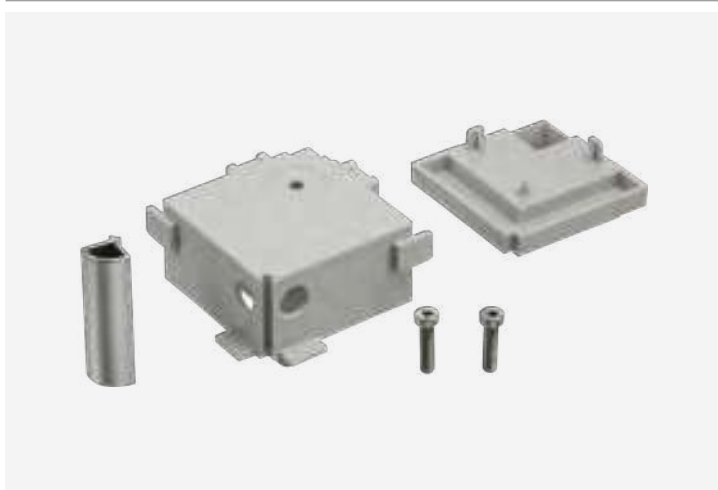

**CORNER JUNCTION KIT FOR TRACK**

composed of:  
 1 corner profile in painted ABS  
 1 structural profile joint insert in grey ABS  
 1 lower structural profile joint insert in grey ABS  
 2 M5x14 mm cylindrical head screws  
 Finish: /6 /88 /91 /97



Art.	Qty
<b>G50KIT05</b>	1 Pc

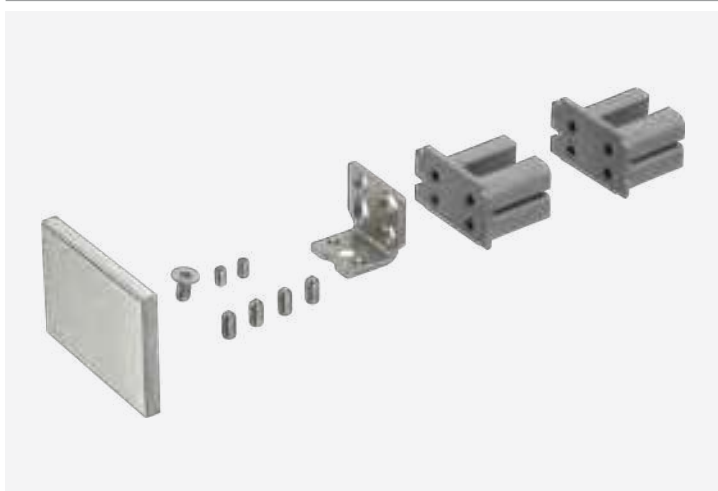

**FIXING KIT FOR BATHTUB EDGE**

composed of:  
 2 POM plastic inserts  
 4 M6x12 mm set screws  
 1 wall fixing bracket 27 mm x 38 mm h 33 mm  
 2 M6x12 mm countersunk screws  
 2 M5x8 mm adjustment set screws  
 1 aluminium finishing cover  
 Finish: /6 /88 /91 /97



Art.	Qty
<b>G50KIT06</b>	1 Pc



**TRACK**

Material: Aluminium  
 Finish: /6 /88 /91 /97

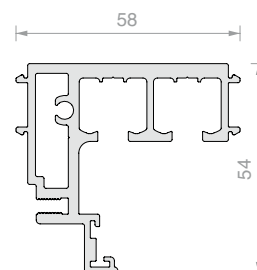

Art.	Length	Qty
<b>LM5859.100</b>	996 mm	1 Pc
<b>LM5859.150</b>	1498 mm	1 Pc
<b>LM5859.200</b>	2000 mm	1 Pc
<b>LM5859.300</b>	3000 mm	1 Pc



**TRACK COVER**

Material: Aluminium  
 Finish: /6 /88 /91 /97

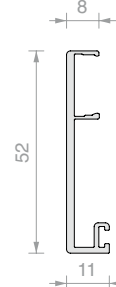

Art.	Length	Qty
<b>LM0859.100</b>	996 mm	1 Pc
<b>LM0859.150</b>	1498 mm	1 Pc
<b>LM0859.200</b>	2000 mm	1 Pc
<b>LM0859.300</b>	3000 mm	1 Pc

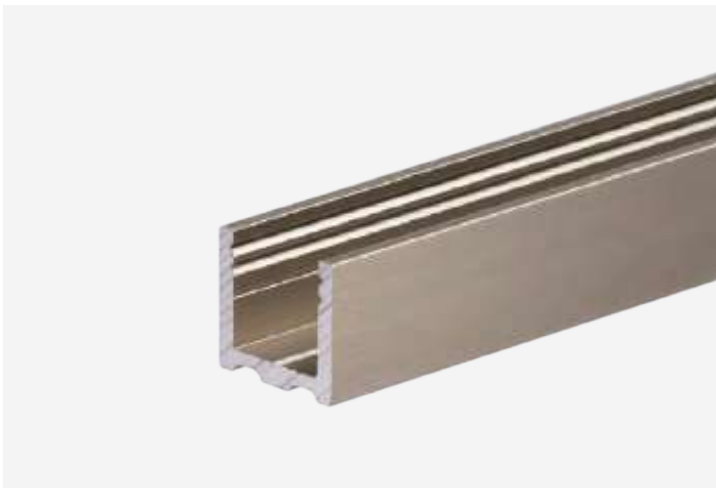

**U-SHAPED PROFILE**

Material: Aluminium

Finish: /6 /88 /91 /97

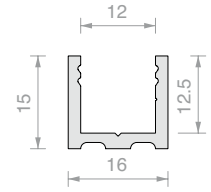

Art.	Length	Qty
<b>PBD3183.150</b>	1498 mm	1 Pc
<b>PBD3183.220</b>	2200 mm	1 Pc
<b>PBD3183</b>	3000 mm	1 Pc



**ROUNDED UPPER PROFILE PBD3184**

Material: Aluminium

Finish: /6 /88 /91 /97

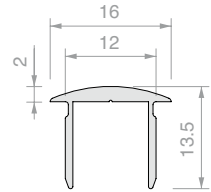

Art.	Length	Qty
<b>PBD3184.100</b>	992 mm	1 Pc
<b>PBD3184.150</b>	1498 mm	1 Pc
<b>PBD3184</b>	3000 mm	1 Pc



**ROUNDED CAP PBD**

Material: Aluminium

Finish: /6 /88 /91 /97

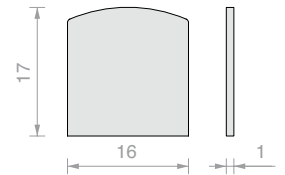

Art.	Qty
<b>PBDTP</b>	1 Pc



**FLAT UPPER PROFILE PBD3186**

Material: Aluminium

Finish: /6 /88 /91 /97

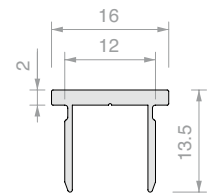

Art.	Length	Qty
<b>PBD3186.100</b>	992 mm	1 Pc
<b>PBD3186.150</b>	1498 mm	1 Pc
<b>PBD3186</b>	3000 mm	1 Pc



**PBD FLAT CAP**

Material: Aluminium

Finish: /6 /88 /91 /97

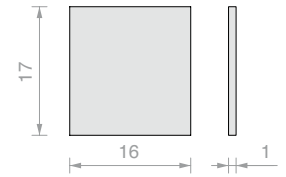

Art.	Qty
<b>PBD86TP</b>	1 Pc



**WATER BARRIER PROFILE**

Material: Aluminium

Finish: /6 /88 /91 /97

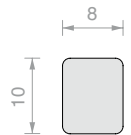

Art.	Length	Qty
<b>PESQ0810.075</b>	747 mm	1 Pc
<b>PESQ0810.150</b>	1498 mm	1 Pc
<b>PESQ0810.300</b>	3000 mm	1 Pc



**SEAL FOR COVER LM0859**

Material: Rubber

Finish: black

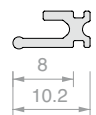
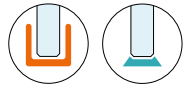

Art.	Qty
<b>057.3078.002</b>	1 m

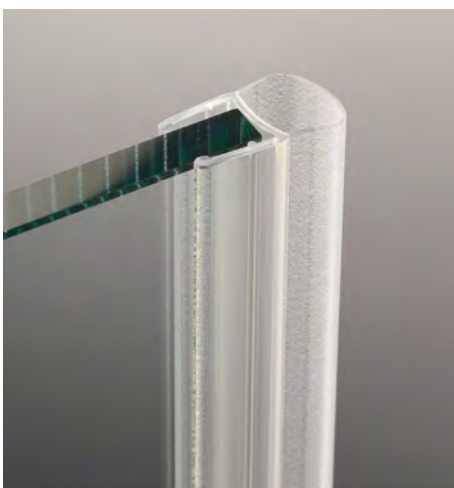

**BALLOON GASKET**

Material: Co-extruded rigid and soft PVC - Resistant to UV rays

Fungicide to prevent mould from forming

Colour: transparent/\*black, transparent balloon

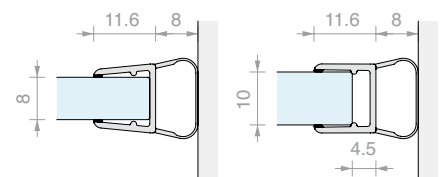
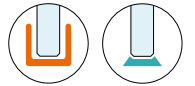

Art.	Length	For glass	Qty
<b>GM06</b>	2000 mm	From 8 to 10 mm	1 Pc
<b>GM0622</b>	2200 mm	From 8 to 10 mm	1 Pc
<b>GM0622NR*</b>	2200 mm	From 8 to 10 mm	1 Pc
<b>GM0625</b>	2500 mm	From 8 to 10 mm	1 Pc
<b>GM0625NR*</b>	2500 mm	From 8 to 10 mm	1 Pc
<b>GM063000</b>	3000 mm	From 8 to 10 mm	1 Pc
<b>GM063000NR*</b>	3000 mm	From 8 to 10 mm	1 Pc



**MAGNETIC 45° GASKET**

Material: Co-extruded rigid and soft PVC  
 Resistant to UV rays  
 Fungicide to prevent mould from forming  
 Maximum operating temperature 70°C  
 Colour: transparent/\*black, white/\*black magnet

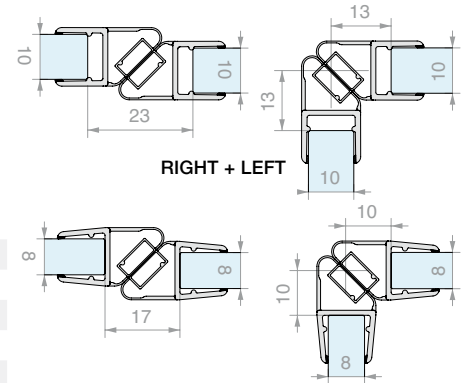
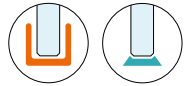

Art.	Length	For glass	Qty
<b>GM1520SX</b>	2200 mm	From 8 to 10 mm	1 Pc
<b>GM1520SXNR*</b>	2200 mm	From 8 to 10 mm	1 Pc
<b>GM1520DX</b>	2200 mm	From 8 to 10 mm	1 Pc
<b>GM1520DXNR*</b>	2200 mm	From 8 to 10 mm	1 Pc
<b>GM15SX</b>	2500 mm	From 8 to 10 mm	1 Pc
<b>GM15DX</b>	2500 mm	From 8 to 10 mm	1 Pc
<b>GM1530SX</b>	3000 mm	From 8 to 10 mm	1 Pc
<b>GM1530DX</b>	3000 mm	From 8 to 10 mm	1 Pc



**GASKET WITH SHORT SIDE LIP**

Material: Co-extruded rigid and soft PVC  
 Fungicide to prevent mould from forming  
 Colour: transparent, embossed lip

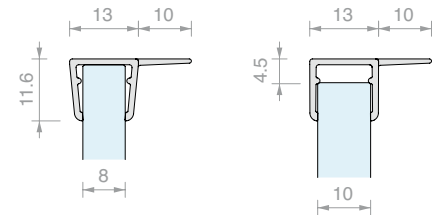
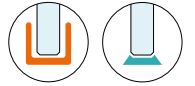

Art.	Length	For glass	Qty
<b>GM01410</b>	2000 mm	From 8 to 10 mm	1 Pc
<b>GM0141022</b>	2200 mm	From 8 to 10 mm	1 Pc
<b>GM0141025</b>	2500 mm	From 8 to 10 mm	1 Pc

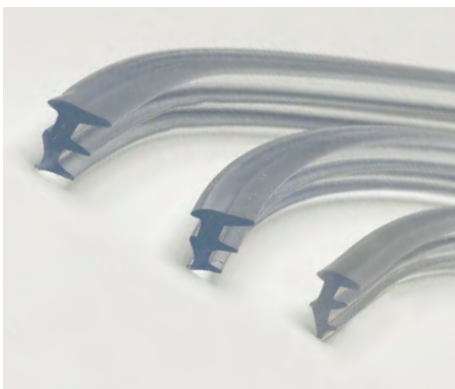

**GLASS HOLDER SEAL**

Material: PVC



Art.	Thickness	Colour	Qty	Art.	Thickness	Colour	Qty	Art.	Thickness	Colour	Qty
<b>GTUP2</b>	2 mm	Transparent	1 m	<b>GTUP2G</b>	2 mm	Embossed	1 m	<b>GTUP2N</b>	2 mm	Black	1 m
<b>GTUP3</b>	3 mm	Transparent	1 m	<b>GTUP3G</b>	3 mm	Embossed	1 m	<b>GTUP3N</b>	3 mm	Black	1 m
<b>GTUP4</b>	4 mm	Transparent	1 m	<b>GTUP4G</b>	4 mm	Embossed	1 m	<b>GTUP4N</b>	4 mm	Black	1 m
<b>GTUP5</b>	5 mm	Transparent	1 m	<b>GTUP5G</b>	5 mm	Embossed	1 m	<b>GTUP5N</b>	5 mm	Black	1 m
<b>GTUP6</b>	6 mm	Transparent	1 m	<b>GTUP6G</b>	6 mm	Embossed	1 m	<b>GTUP6N</b>	6 mm	Black	1 m



**MAGNETIC IN-LINE GASKET**

Material: Co-extruded rigid and soft PVC  
 Colour: transparent embossed, white magnet

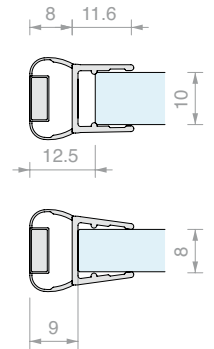
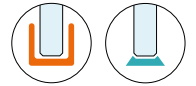

Art.	Length	For glass	Qty
<b>GM1720SX</b>	2200 mm	From 8 to 10 mm	1 Pc
<b>GM17SX</b>	2500 mm	From 8 to 10 mm	1 Pc
<b>GM1730SX</b>	3000 mm	From 8 to 10 mm	1 Pc



**MAGNETIC EXTENSION PROFILE**

Material: Aluminium  
 Finish: /91

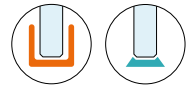

Glass thickness	Art.	Air between the glass and profile
6 mm	<b>GM11SX</b>	10 mm
6 mm	<b>GM66SX</b>	8 mm
8 mm	<b>GM11SX</b>	10 mm
8 mm	<b>GM66SX</b>	10 mm
6 mm	<b>GM12SX2500</b>	10 mm
8 mm	<b>GM6630SX</b>	8 mm

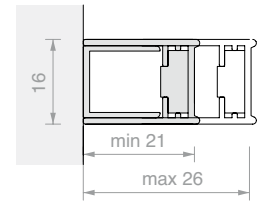

Art.	Length	Qty
<b>PBCAL10</b>	2300 mm	1 Pc



**SNAP-ON FLOOR GUIDE FOR GLASS WITH PROFILE**

Material: Zamak, ABS  
 Compatible with aluminium profiles in the PBD and LMU series  
 Finish: /1 /24 /97 /R2

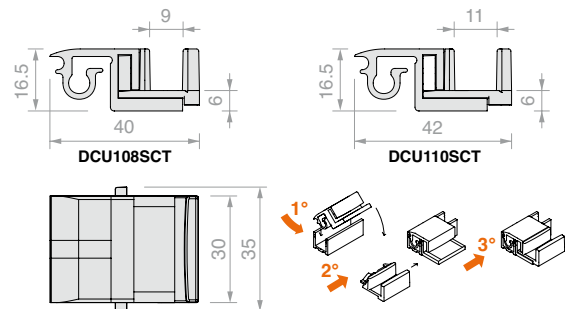

Art.	For glass	Qty
<b>DCU108SCT</b>	8 mm	1 Pc
<b>DCU110SCT</b>	10 mm	1 Pc



**FLOOR GUIDE FOR GLASS WITH PROFILE**

Material: ABS  
Finish: /88 /91 /97 /R2

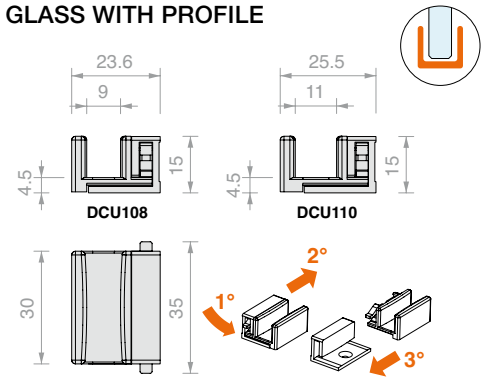

Art.	For glass	Qty
<b>DCU108</b>	8 mm	1 Pc
<b>DCU110</b>	10 mm	1 Pc



**FLOOR GUIDE FOR GLASS WITH PROFILE AND DRIP FLAP**

Material: ABS  
Finish: /88 /91 /97 /R2

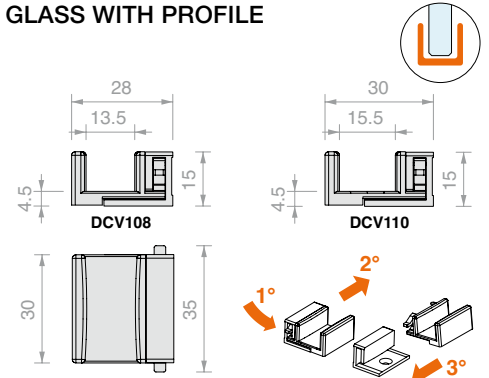

Art.	For glass	Qty
<b>DCV108</b>	8 mm	1 Pc
<b>DCV110</b>	10 mm	1 Pc



**FLOOR GUIDE FOR SEALED GLASS AND DRIP FLAP**

Material: ABS  
Finish: /88 /91 /97 /R2

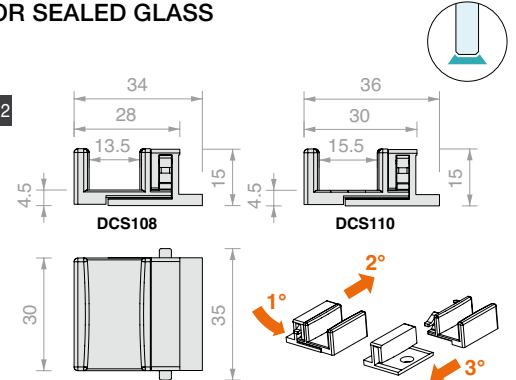

Art.	For glass	Qty
<b>DCS108</b>	8 mm	1 Pc
<b>DCS110</b>	10 mm	1 Pc



**GASKET WITH DRIP FLAP**

Material: Rigid PVC  
Colour: transparent

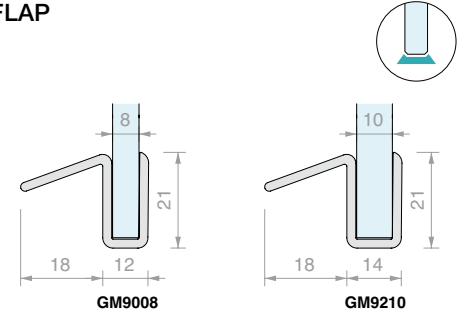

Art.	Length	For glass	Qty
<b>GM900807</b>	750 mm	8 mm	1 Pc
<b>GM900815</b>	1500 mm	8 mm	1 Pc
<b>GM921007</b>	750 mm	10 mm	1 Pc
<b>GM921015</b>	1500 mm	10 mm	1 Pc





**CORNER JOINT FOR PROFILE**

Material: Zamak

Compatible with aluminium profiles in the PBD and LMU series

For PBD3184 upper profile

Finish: /1 /6 /24 /97

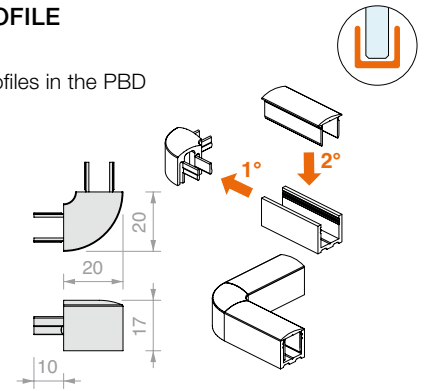

Art.

**DCC90**

Qty

1 Pc



**FLAT CORNER JOINT FOR PROFILE**

Material: Zamak

Compatible with aluminium profiles in the PBD and LMU series

For PBD3186 upper profile

Finish: /1 /6 /24 /97

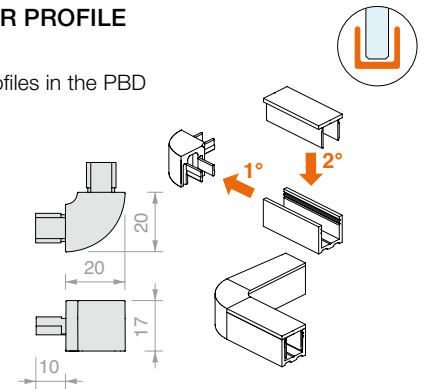

Art.

**DCC90SQ**

Qty

1 Pc



**CORNER JOINT FOR PESQ WATER BARRIER PROFILE**

Material: PPA

Finish: /88 /91 /97 /R2

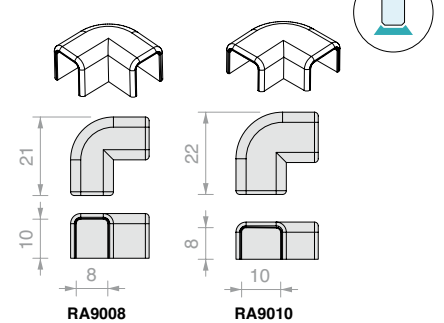

Art.

**RA9008**

For glass

From 6 to 8 mm

Qty

1 Pc

**RA9010**

10 mm

Qty

1 Pc



**HALF ROUND ADHESIVE PROTECTORS**

Material: Polyurethane, self-adhesive, acrylic quick-setting glue.

Resistant to UV rays, does not turn yellow

Colour: transparent

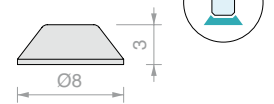

Art.

**GOC009**

Pcs per sheet

288

Hardness

66-70 Shore A

Qty

1 Pc



**ADJUSTMENT WRENCH**

Material: Steel

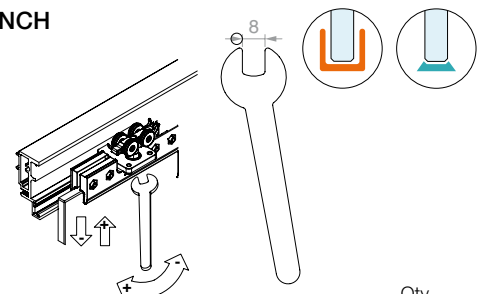

Art.

**GOCCHIA08**

Qty

1 Pc



**WALL/TRACK STABILIZER BAR WITH DOUBLE JOINT**

Material: Brass  
 Finish: /1 /24 /97 /R2

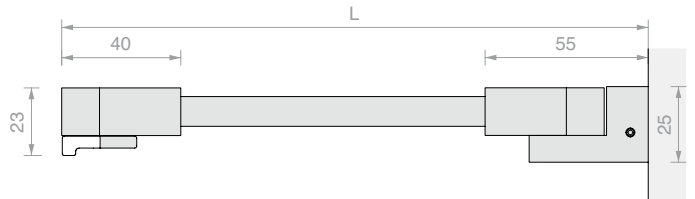
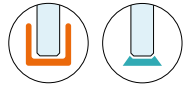

Art.	L	Qty
<b>DQGKT01</b>	557 mm	1 Pc
<b>DQGKT03</b>	1057 mm	1 Pc



**RECTANGULAR BAR**

Material: Brass  
 Finish: /1 /2 /4 /24 /97 /R2  
 \* not available in /97

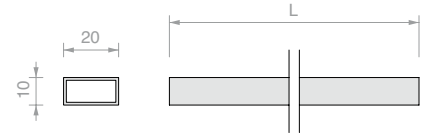
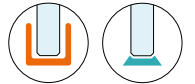

Art.	L	Qty
<b>DQA05</b>	500 mm	1 Pc
<b>DQA06</b>	1000 mm	1 Pc
<b>DQA08*</b>	1500 mm	1 Pc



**ARTICULATED WALL FIXING**

Material: Brass  
 Finish: /1 /2 /4 /24 /97 /R2

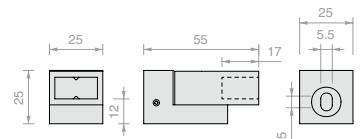
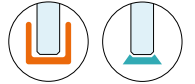

Art.	Qty
<b>DQA88</b>	1 Pc



**JOINTED TRACK FIXING**

Material: Brass  
 Finish: /1 /24 /97 /R2

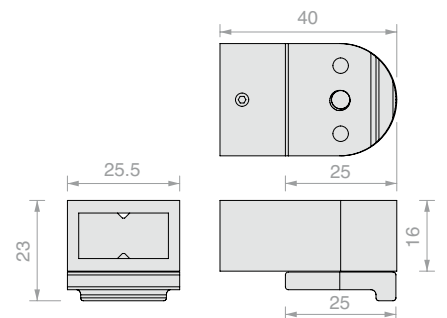

Art.	Qty
<b>DQG26</b>	1 Pc



**MAN500V150 ADHESIVE HANDLE**

Material: Aluminium  
 Finish: /88 /91 /97 /R2

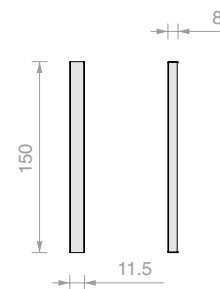

Art. **MAN500V150** Qty 1 Pc



**HAND6640VHB ADHESIVE HANDLE**

Material: Aluminium  
 Finish: /1 /6 /88 /91 /97

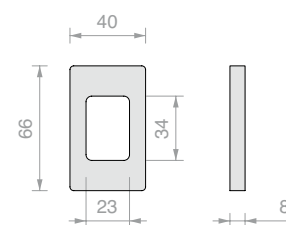

Art. **HAND6640VHB** Qty 1 Pc



**HAND10052VHB ADHESIVE HANDLE**

Material: Aluminium  
 Finish: /1 /6 /88 /91 /97

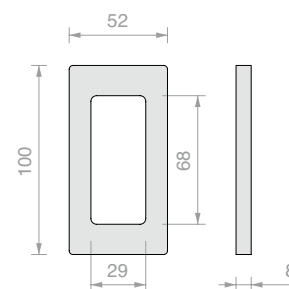

Art. **HAND10052VHB** Qty 1 Pc



**HAND13040VHB ADHESIVE HANDLE**

Material: Aluminium  
 Finish: /1 /6 /88 /91 /97

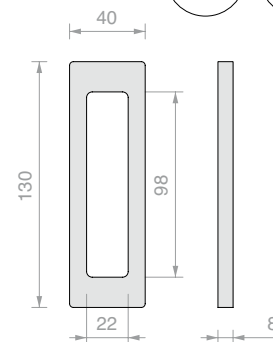

Art. **HAND13040VHB** Qty 1 Pc

# GLMFLAT

## *Design*

The lightness of an all-glass system is combined with straight lines and the beauty of steel.

Sliding wheels visible on a minimal 30 mm x 10 mm rail. This is the GLMFLAT system.

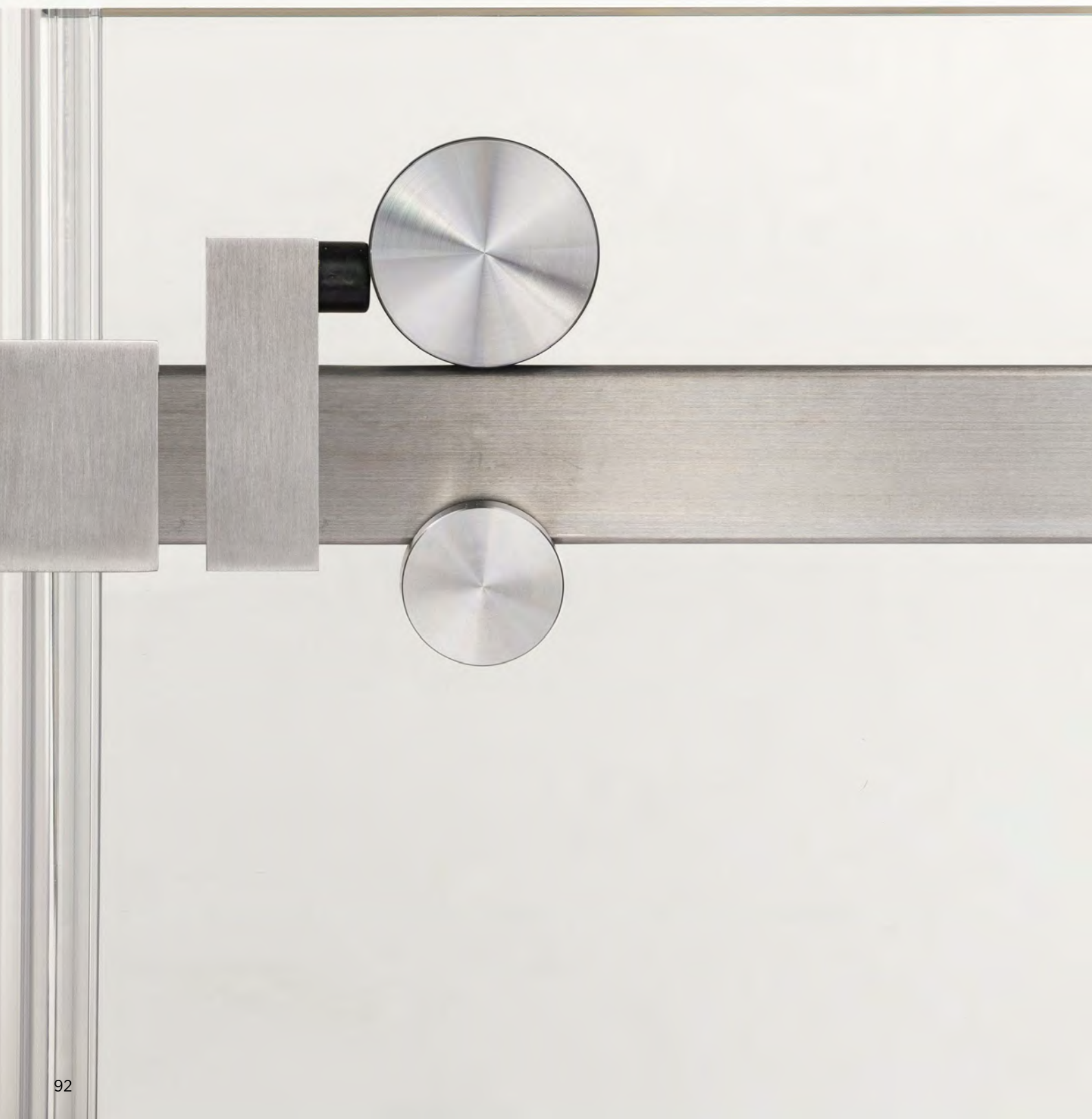



**/8**  
Brushed steel

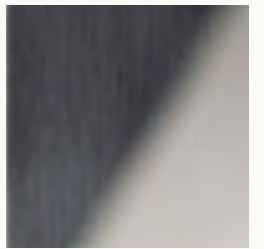

**/15**  
Polished steel



# GLMFLAT

## Technical properties

Sliding door system for 8-mm glass with visible mechanisms.  
 The carriers and stabilisation accessories slide on a robust yet minimal track to move doors weighing up to 35 kg. From the end stop to the bottom rail, the system is equipped with sophisticated accessories, without limiting functionality or reliability.

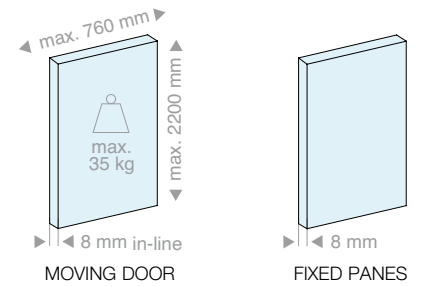

### 4 configurations

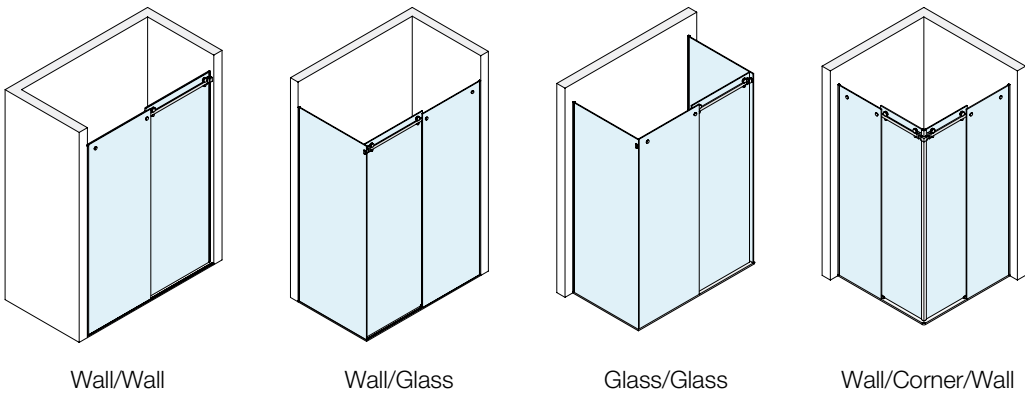

### 2 types of installation

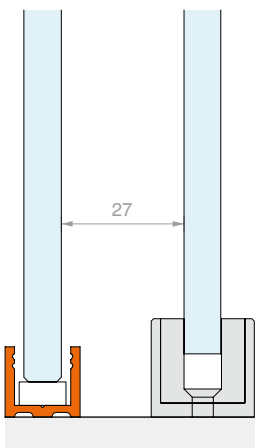
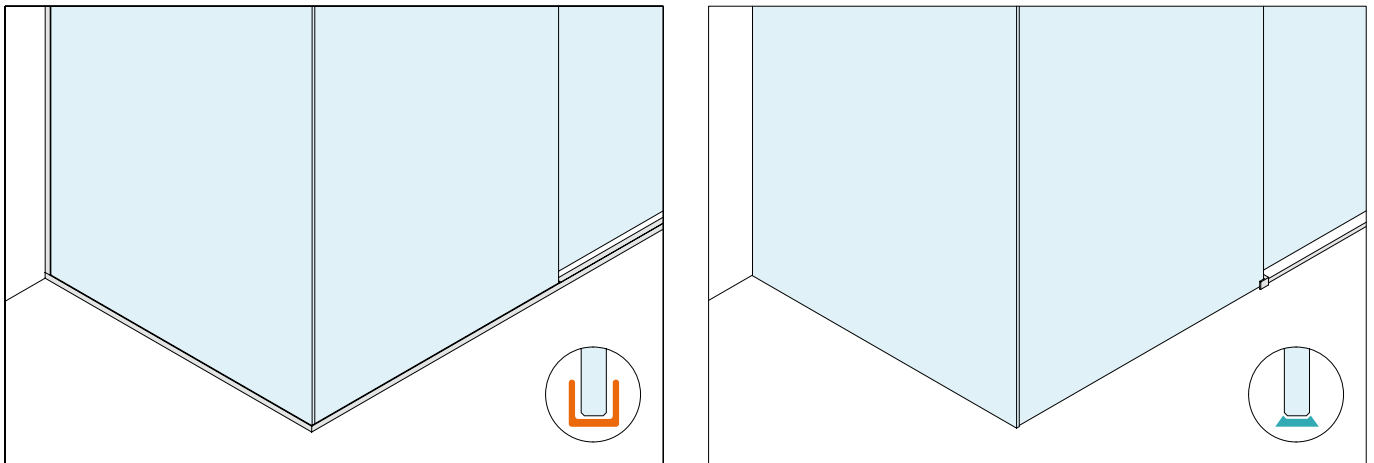

**Kits**  
*With framed fixed panes*

Simple, modern design.  
 With this solution, fixed glass panes are installed within a 15 mm x 16 mm aluminium profile. The same profile, with an upper snap-on cover, acts as a water barrier in the open area.

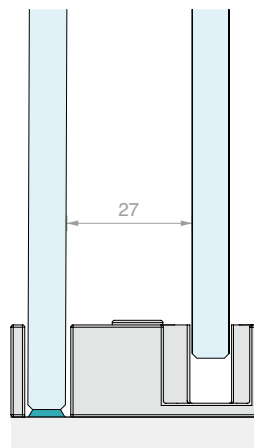

**Kits**  
*With sealed fixed panes*

Elegance and perfect transparency.  
 With this solution, fixed panes are sealed to the support surfaces. A space-saving water barrier profile in aluminium, 5 mm high, can be installed at the opening.

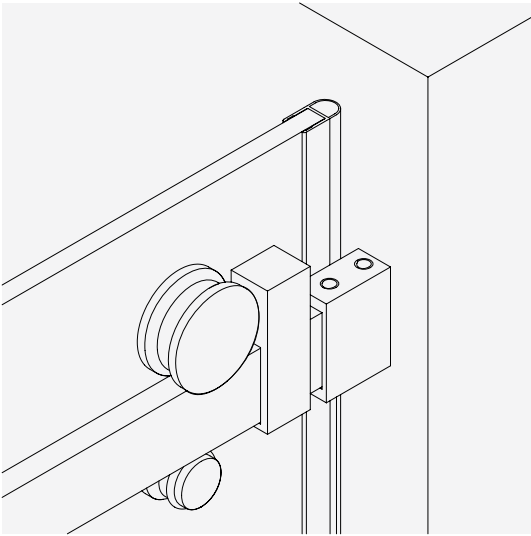

**VISIBLE MECHANISMS**  
 The sliding wheels and external anti-derailment devices highlight the functional parts

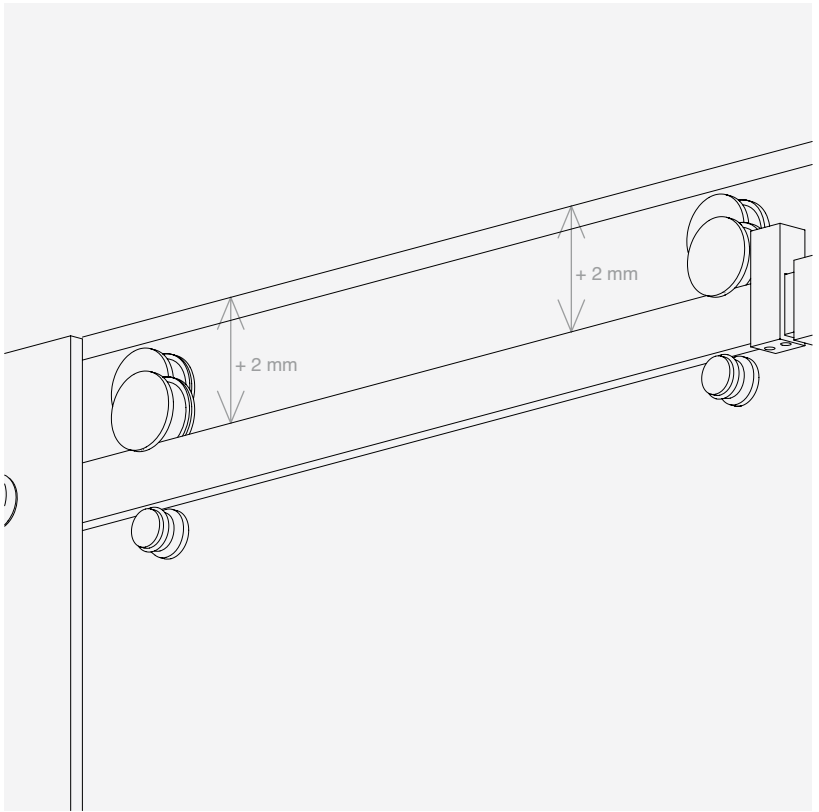

**ADJUSTMENT**  
 The height adjustment of the individual carrier allows the position and inclination of the door to be recorded

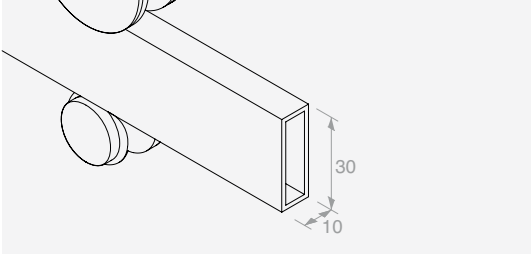

**MINIMAL DESIGN**  
 The design combines essential aesthetics and functional elegance

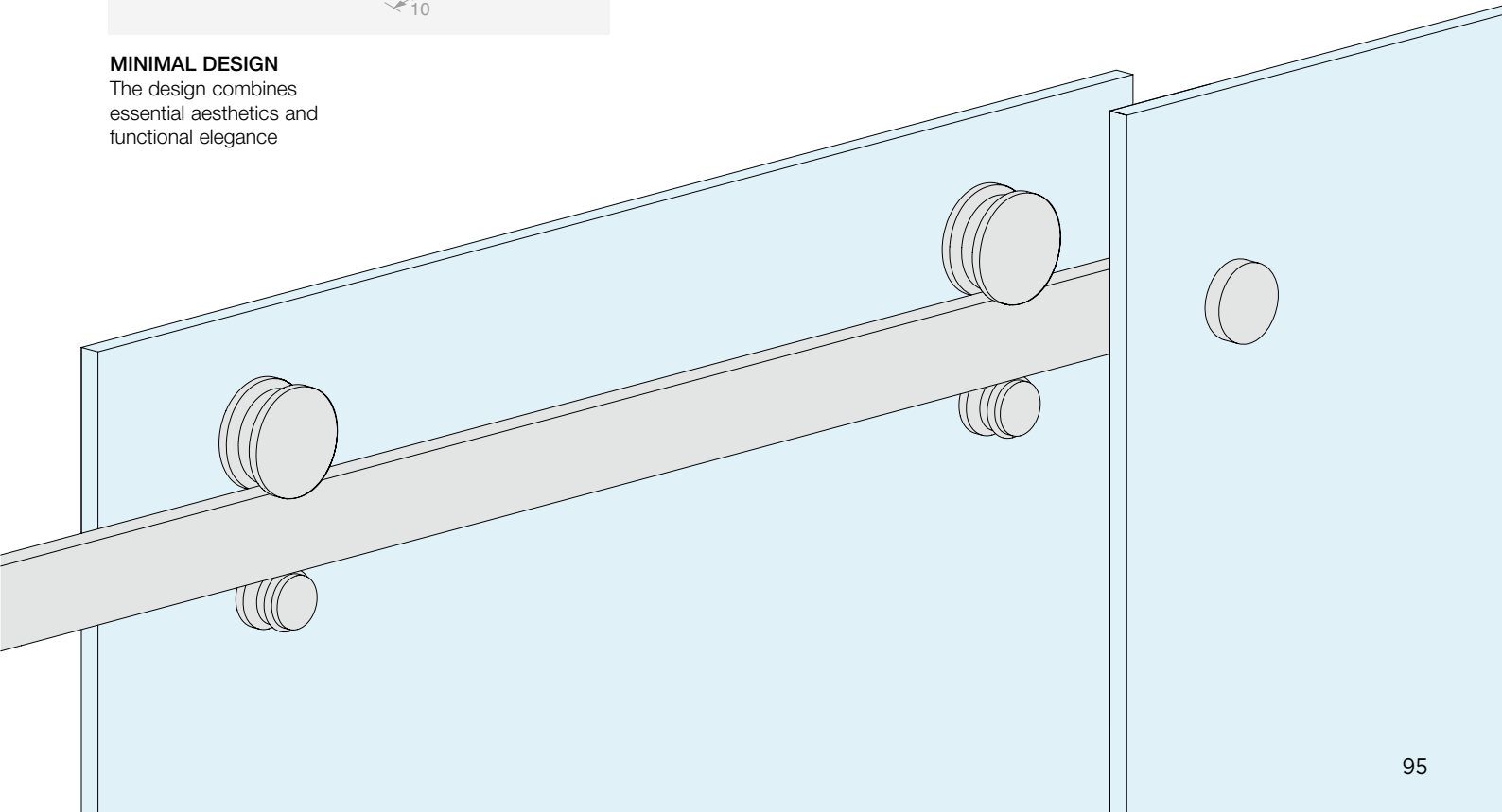





# GLMFLAT

*Kit*



## CONFIGURATIONS WITH FRAMED FIXED PANES

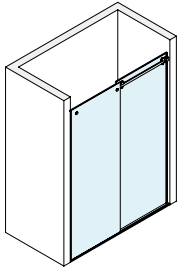

Page 99

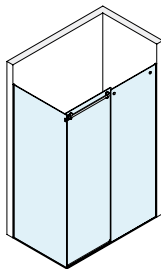

Page 100

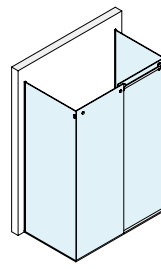

Page 101

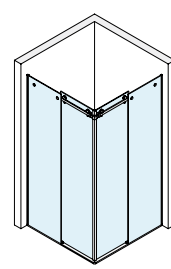

Page 103

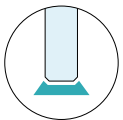

## CONFIGURATIONS WITH SEALED FIXED PANES

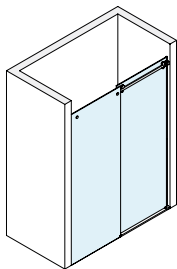

Page 105

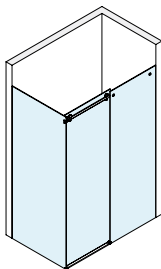

Page 106

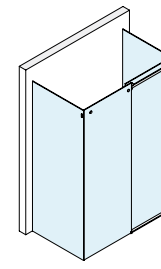

Page 107

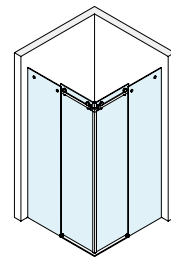

Page 109



**WALL/WALL SLIDING DOOR SHOWER KIT WITH FRAME PROFILE FOR FIXED PANE**

Finish: /8 /15

Handle to be ordered separately

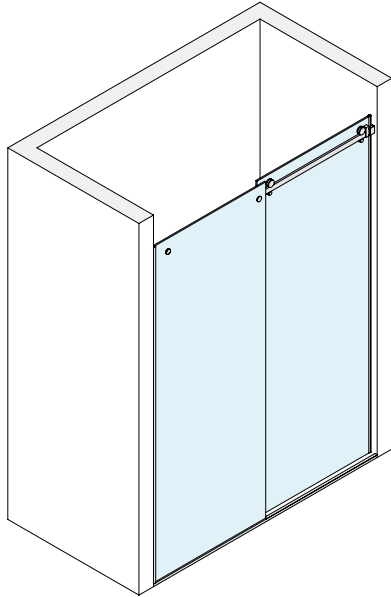

Kit comprising:

Art.	Description	Qty
<b>GLMFLATMUR</b>	Wall/wall accessories kit	1 Pc
<b>GLMSPA08</b>	Floor guide	1 Pc
<b>GLMFT2000</b>	Track	1 Pc
<b>PBD3183.220</b>	U-shaped profile	2 Pcs
<b>PBD3184.150</b>	Rounded upper profile	1 Pc
<b>GTUP4</b>	Glass holder gasket	3 m
<b>GM01422</b>	Gasket with side lip	1 Pc
<b>GM0622</b>	Balloon gasket	1 Pc
Optional		
<b>GLMSFORO</b>	Cutting and drilling	1 Pc

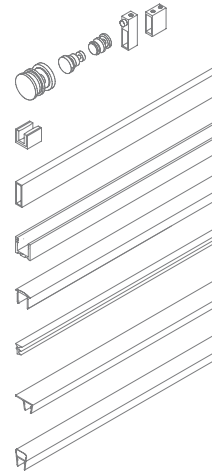

RECOMMENDED LAYOUTS

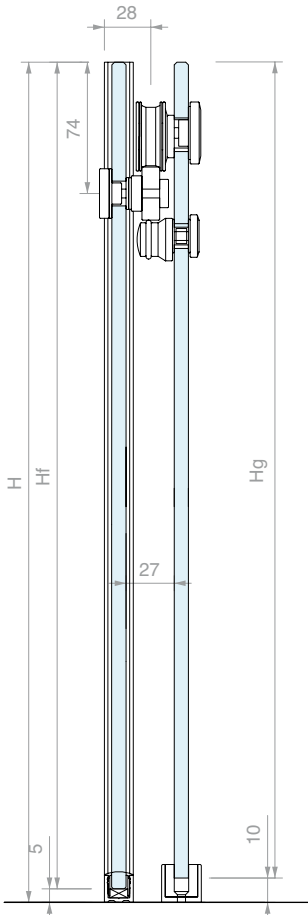

GLASS PANE DIMENSIONS

$L_g = (LV + 19) / 2$

$L_f = L_g$

$H_g = H - 10$

$H_f = H - 5$

$LA = (LV - 112) / 2$

PRIMARY LENGTHS (mm)

LV	Lg	Lf	LA
1500	760	760	694
1400	710	710	644
1300	660	660	594
1200	610	610	544

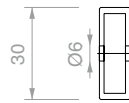

TRACK PROCESSING

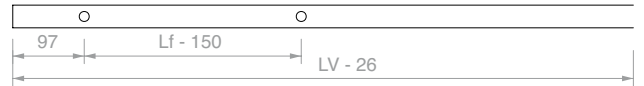

CLOSED SLIDING DOOR CONFIGURATION

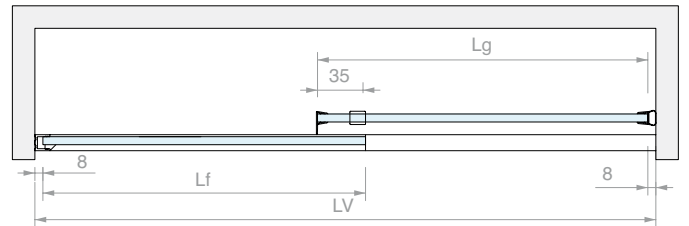

OPEN SLIDING DOOR CONFIGURATION

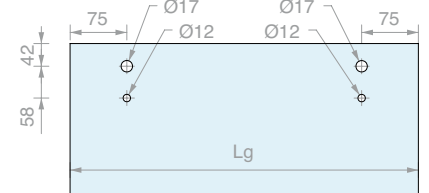
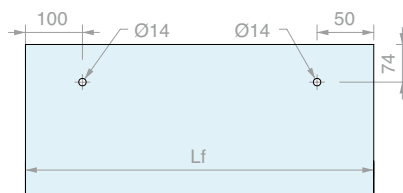
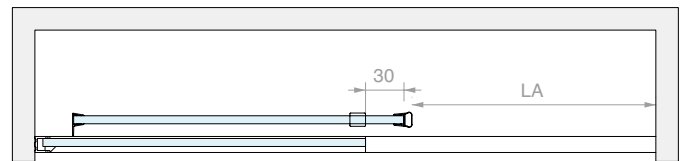

Art. **GLMFLAT030**

Qty  
1 Pc



**WALL/GLASS SLIDING DOOR SHOWER KIT WITH FRAME PROFILE FOR FIXED PANES**

Finish: /8 /15

Handle to be ordered separately

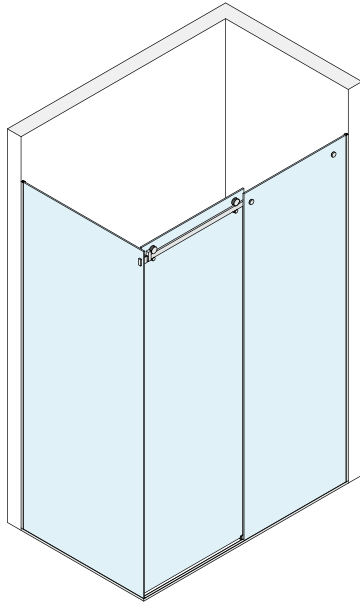

Kit comprising:

Art.	Description	Qty
<b>GLMFLATVET</b>	Wall/glass accessories kit	1 Pc
<b>GLMSPA08</b>	Floor guide	1 Pc
<b>GLMFT2000</b>	Track	1 Pc
<b>PBD3183.220</b>	U-shaped profile	3 Pcs
<b>PBD3183.150</b>	U-shaped profile	1 Pc
<b>PBD3184.150</b>	Rounded upper profile	1 Pc
<b>GTUP4</b>	Glass holder gasket	9 m
<b>GM01422</b>	Gasket with side lip	1 Pc
<b>GM0622</b>	Balloon gasket	1 Pc
Optional		
<b>GLMSFORO</b>	Cutting and drilling	1 Pc

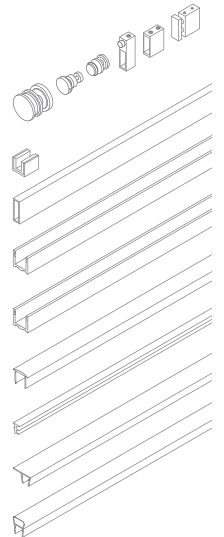

RECOMMENDED LAYOUTS

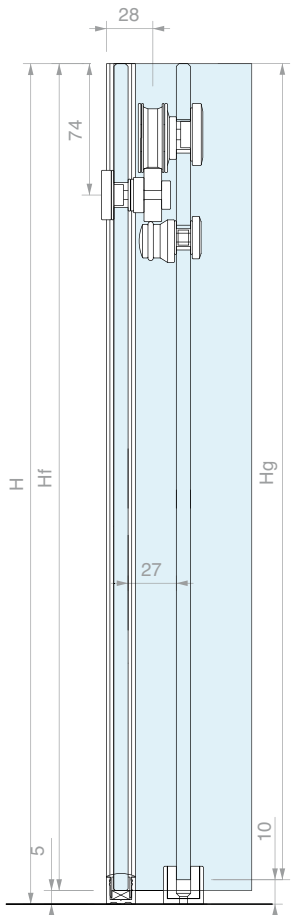

GLASS PANE DIMENSIONS

$L_g = (LV + 5) / 2$   
 $L_f = L_g$

$H_g = H - 10$   
 $H_f = H - 5$

$L_l = P - 14$   
 $H_l = H - 5$

$LA = (LV - 126) / 2$

PRIMARY LENGTHS (mm)

LV	Lg	Lf	LA
1500	753	703	687
1400	703	703	637
1300	653	653	587
1200	603	603	537

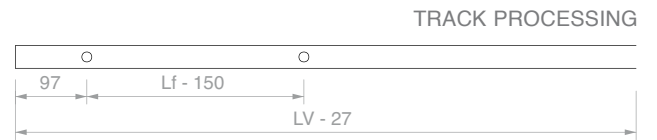
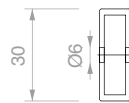

CLOSED SLIDING DOOR CONFIGURATION

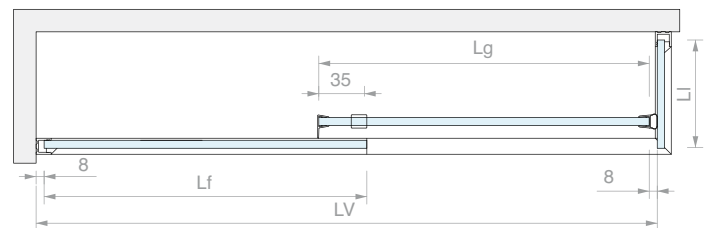

OPEN SLIDING DOOR CONFIGURATION

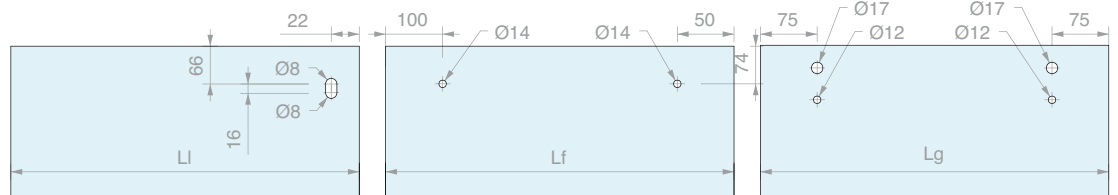
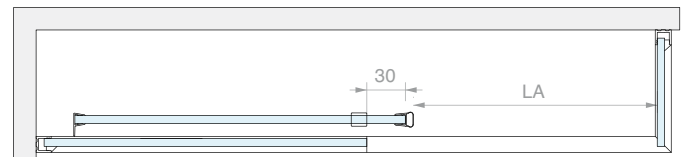

Art.  
**GLMFLAT034**

Qty  
**1 Pc**



**GLASS/GLASS SLIDING DOOR SHOWER KIT WITH FRAME PROFILE FOR FIXED PANES**

Finish: /8 /15

Handle to be ordered separately

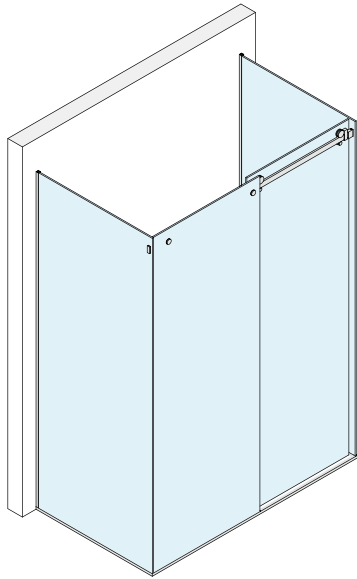

Kit comprising:

Art.	Description	Qty	
<b>GLMFT12</b>	Sliding wheel	2 Pcs	
<b>GLMFT14</b>	Eccentric anti-derailment wheel	2 Pcs	
<b>GLMFT16</b>	Fixing for fixed glass	2 Pcs	
<b>GLMFT37</b>	Glass fixing	2 Pcs	
<b>DCCFT20</b>	End stop	2 Pcs	
<b>GLMSPA08</b>	Floor guide	1 Pc	
<b>GLMFT2000</b>	Track	1 Pc	
<b>PBD3183.220</b>	U-shaped profile	4 Pcs	
<b>PBD3184.150</b>	Rounded upper profile	1 Pc	
<b>GTUP4</b>	Glass holder gasket	9 m	
<b>GM01422</b>	Gasket with side lip	1 Pc	
<b>GM0622</b>	Balloon gasket	1 Pc	
Optional			
<b>GLMSFORO</b>	Cutting and drilling	1 Pc	



RECOMMENDED LAYOUTS

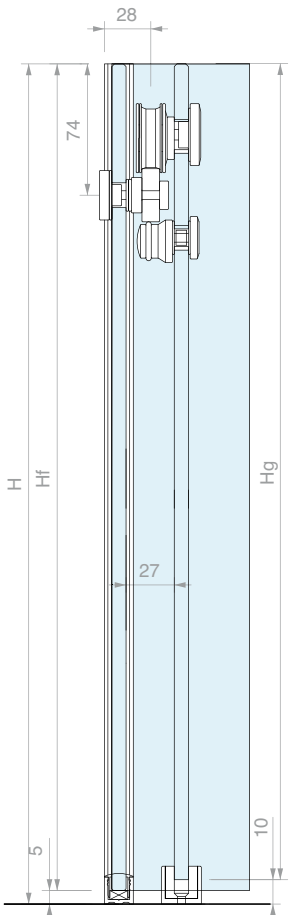

GLASS PANE DIMENSIONS

$L_g = LV / 2$   
 $L_f = L_g$

$H_g = H - 10$   
 $H_f = H - 5$

$L_i = P - 14$   
 $H_i = H - 5$

$LA = (LV - 140) / 2$

PRIMARY LENGTHS (mm)

LV	Lg	Lf	LA
1500	750	750	680
1400	700	700	630
1300	650	650	580
1200	600	600	530

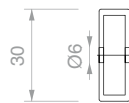

TRACK PROCESSING

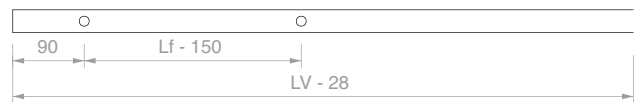

CLOSED SLIDING DOOR CONFIGURATION

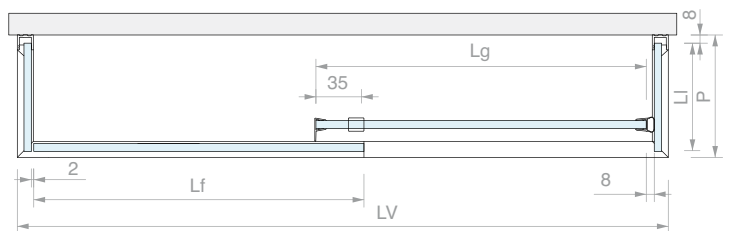

OPEN SLIDING DOOR CONFIGURATION

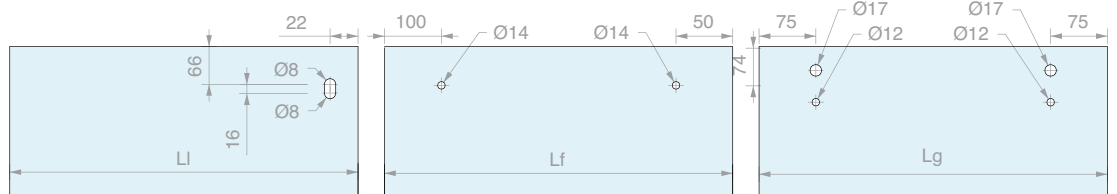
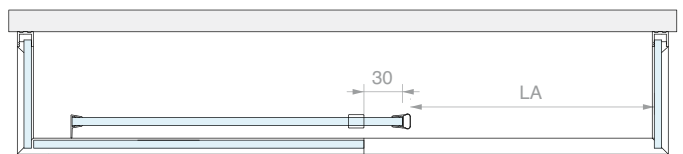

Art.  
**GLMFLAT042**

Qty  
 1 Pc





**WALL/CORNER/WALL SLIDING DOOR SHOWER KIT WITH FRAME PROFILE FOR FIXED PANES**

Finish: /8 /15

Handle to be ordered separately

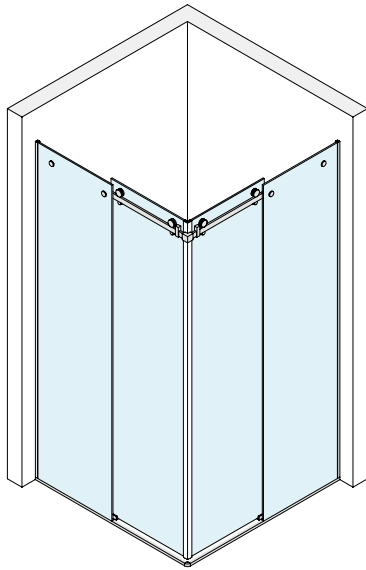

Kit comprising:

Art.	Description	Qty	
<b>GLMFT12</b>	Wall/glass accessories kit	4 Pcs	
<b>GLMFT14</b>	Eccentric anti-derailment wheel	4 Pcs	
<b>GLMFT16</b>	Fixing for fixed glass	4 Pcs	
<b>GLMFT18</b>	Wall fixing	2 Pcs	
<b>GLMFT90</b>	Corner fixing	1 Pc	
<b>DCCFT20</b>	End stop	4 Pcs	
<b>GLMSPA08</b>	Floor guide	2 Pcs	
<b>DCC90</b>	Corner junction	1 Pc	
<b>GLMFT1000</b>	Track	2 Pcs	
<b>PBD3183.220</b>	U-shaped profile	2 Pcs	
<b>PBD3183.150</b>	U-shaped profile	2 Pcs	
<b>PBD3184.150</b>	Rounded upper profile	1 Pc	
<b>GTUP4</b>	Glass holder gasket	9 m	
<b>GM01422</b>	Gasket with side lip	2 Pcs	
<b>GM62SX</b>	45° magnetic gasket	1 Pc	
<b>GM62DX</b>	45° magnetic gasket	1 Pc	



RECOMMENDED LAYOUTS

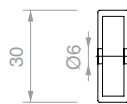
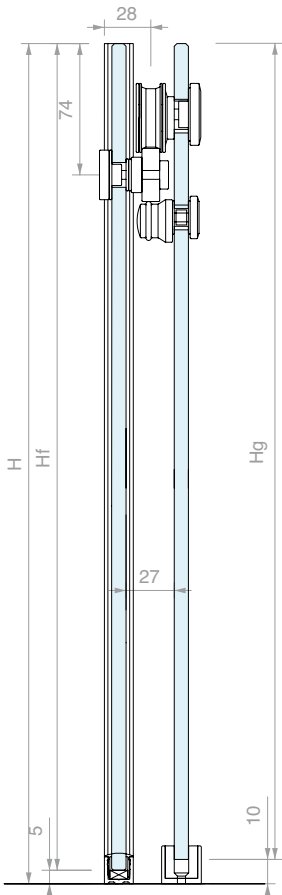

TRACK PROCESSING

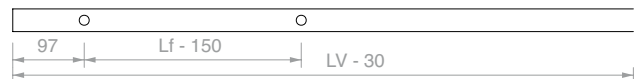

CLOSED SLIDING DOOR CONFIGURATION

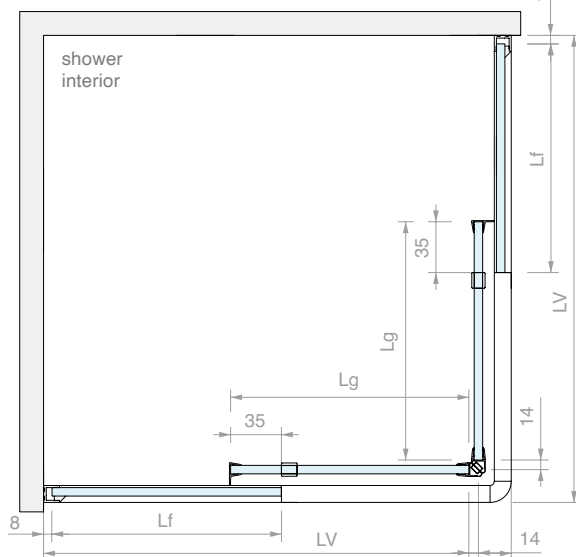

OPEN SLIDING DOOR CONFIGURATION

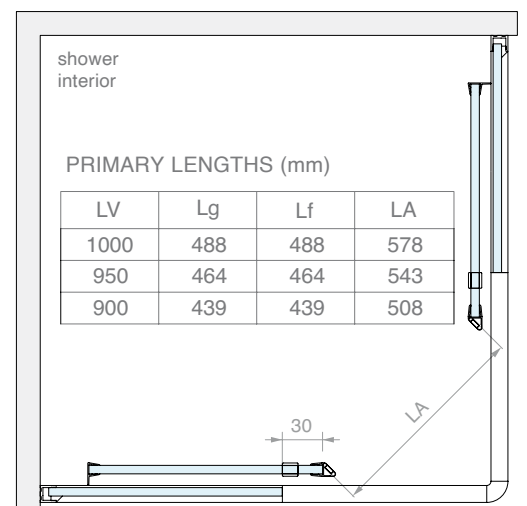

PRIMARY LENGTHS (mm)

LV	Lg	Lf	LA
1000	488	488	578
950	464	464	543
900	439	439	508

GLASS PANE DIMENSIONS

$Lg = (LV - 23) / 2$   
 $Lf = Lg$   
 $Hg = H - 10$   
 $Hf = H - 6$   
 $LA = 0.7 \times (LV - 174)$

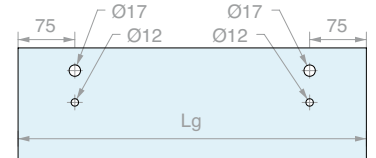
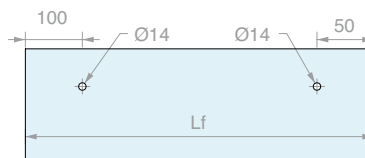

Art. **GLMFLAT038**

Qty  
1 Pc





**WALL/WALL SLIDING DOOR SHOWER KIT FOR SEALED FIXED PANE**

Finish: /8 /15

Handle to be ordered separately

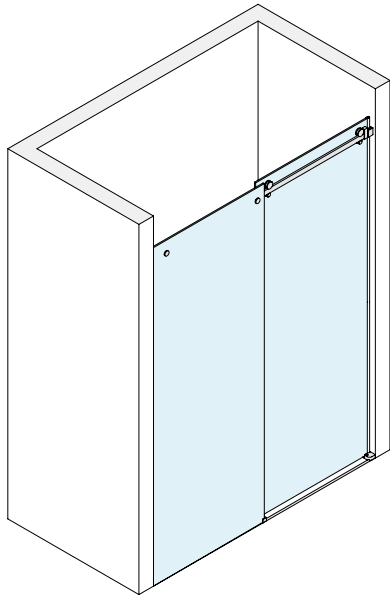

TOWARDS RIGHT

Kit comprising:

Art.	Description	Qty
<b>GLMFLATMUR</b>	Wall/wall accessories kit	1 Pc
<b>BDFIX-DX/SX</b>	Floor guide	1 Pc
<b>BDFIX2-DX/SX</b>	Floor guide	1 Pc
<b>GLMFT2000</b>	Track	1 Pc
<b>BDFIX10</b>	Water barrier profile	1 Pc
<b>GM01422</b>	Gasket with side lip	1 Pc
<b>GM5610</b>	Gasket with drip flap	1 Pc
<b>GM0622</b>	Balloon gasket	1 Pc
Optional		
<b>GLMSFORO</b>	Cutting and drilling	1 Pc

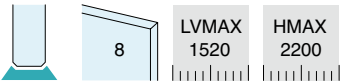
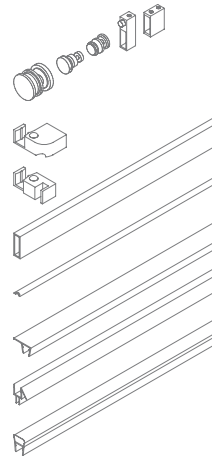

RECOMMENDED LAYOUTS

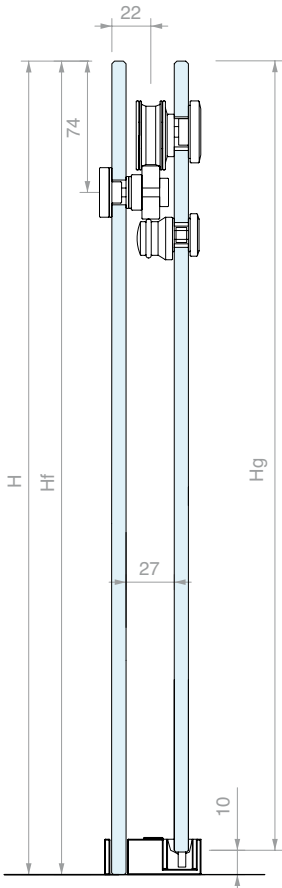

GLASS PANE DIMENSIONS

$$L_g = (LV + 25) / 2$$

$$L_f = L_g$$

$$H_g = H - 10$$

$$H_f = H - 1$$

$$L_A = (LV - 106) / 2$$

PRIMARY LENGTHS (mm)

LV	Lg	Lf	LA
1500	763	763	697
1400	713	713	647
1300	663	663	597
1200	613	613	547

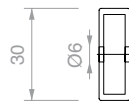

TRACK PROCESSING

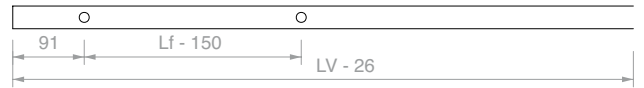

CLOSED SLIDING DOOR CONFIGURATION

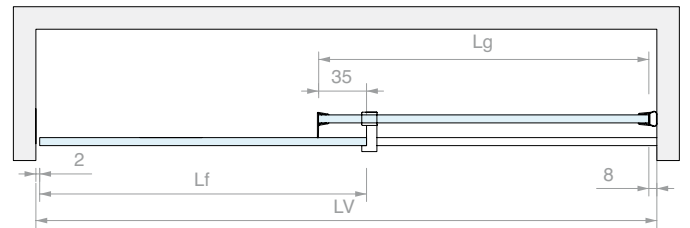

OPEN SLIDING DOOR CONFIGURATION

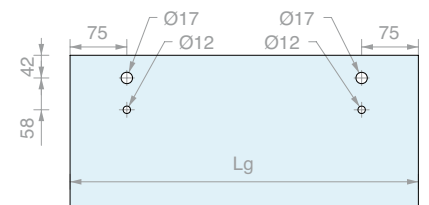
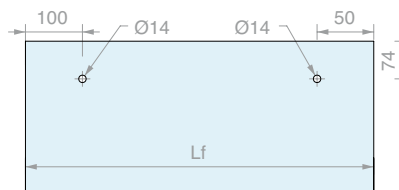
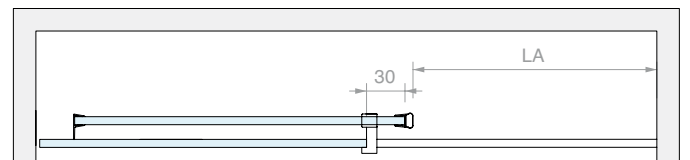

Art.	Description	Qty
<b>GLMFLAT028SX</b>	Towards left	1 Pc
<b>GLMFLAT028DX</b>	Towards right	1 Pc



**WALL/GLASS SLIDING DOOR SHOWER KIT FOR SEALED FIXED PANES**

Finish: /8 /15

Handle to be ordered separately

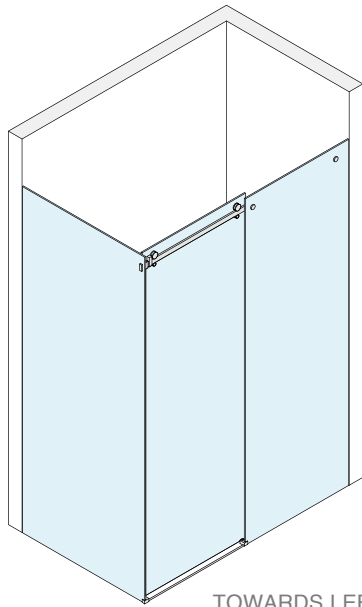

Kit comprising:

Art.	Description	Qty
<b>GLMFLATVET</b>	Wall/glass accessories kit	1 Pc
<b>BDFIX5-DX/SX</b>	Floor guide	1 Pc
<b>BDFIX2-DX/SX</b>	Floor guide	1 Pc
<b>GLMFT2000</b>	Track	1 Pc
<b>BDFIX10</b>	Water barrier profile	1 Pc
<b>GM01422</b>	Gasket with side lip	1 Pc
<b>GM5610</b>	Gasket with drip flap	1 Pc
<b>GM0622</b>	Balloon gasket	1 Pc
Optional		
<b>GLMSFORO</b>	Cutting and drilling	1 Pc

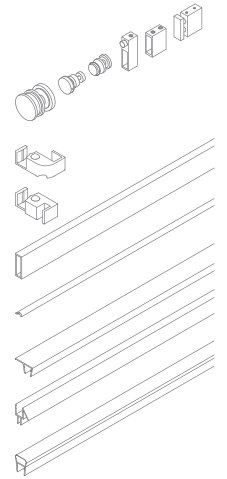

RECOMMENDED LAYOUTS

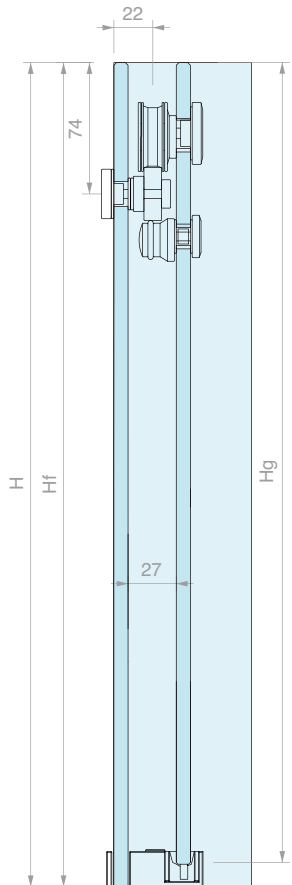

GLASS PANE DIMENSIONS

$L_g = (LV + 17) / 2$   
 $L_f = L_g$

$H_g = H - 10$   
 $H_f = H - 1$

$L_l = P - 2$   
 $H_l = H - 1$

$L_A = (LV - 114) / 2$

PRIMARY LENGTHS (mm)

LV	Lg	Lf	LA
1500	759	759	697
1400	709	709	647
1300	659	659	597
1200	609	609	547

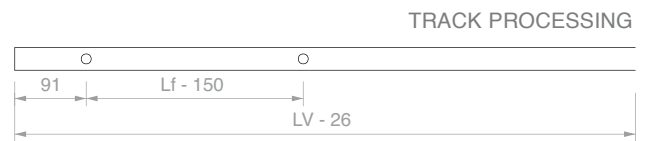
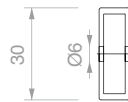

CLOSED SLIDING DOOR CONFIGURATION

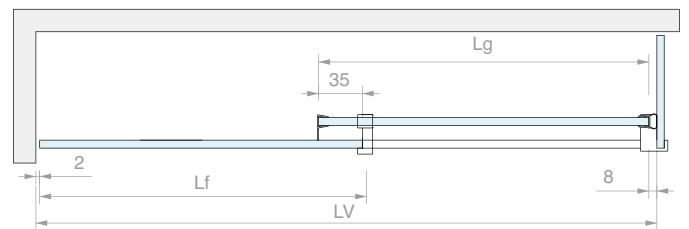

OPEN SLIDING DOOR CONFIGURATION

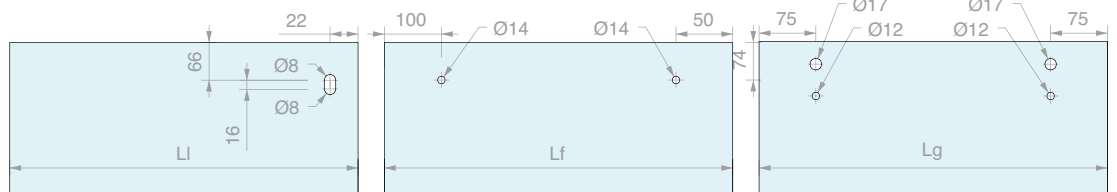
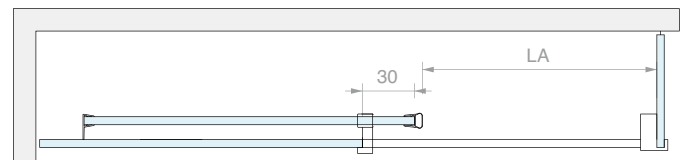

Art.	Description	Qty
<b>GLMFLAT032SX</b>	Towards left	1 Pc
<b>GLMFLAT032DX</b>	Towards right	1 Pc

**GLASS/GLASS SLIDING DOOR SHOWER KIT FOR SEALED FIXED PANES**





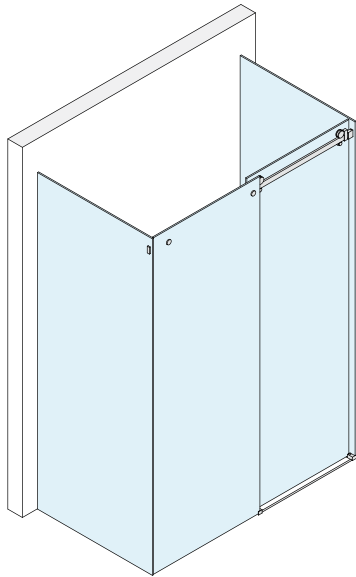







Finish: /8 /15

Handle to be ordered separately



TOWARDS RIGHT

Kit comprising:

Art.	Description	Qty	
<b>GLMFT12</b>	Sliding wheel	2 Pcs	
<b>GLMFT14</b>	Eccentric anti-derailment wheel	2 Pcs	
<b>GLMFT16</b>	Fixing for fixed glass	2 Pcs	
<b>GLMFT37</b>	Glass fixing	2 Pcs	
<b>DCCFT20</b>	End stop	2 Pcs	
<b>BDFIX5-DX/SX</b>	Floor guide	1 Pc	
<b>BDFIX2-DX/SX</b>	Floor guide	1 Pc	
<b>GLMFT2000</b>	Track	1 Pc	
<b>BDFIX10</b>	Water barrier profile	1 Pc	
<b>GM01422</b>	Gasket with side lip	1 Pc	
<b>GM5610</b>	Gasket with drip flap	1 Pc	
<b>GM0622</b>	Balloon gasket	1 Pc	
Optional			
<b>GLMSFORO</b>	Cutting and drilling	1 Pc	



RECOMMENDED LAYOUTS

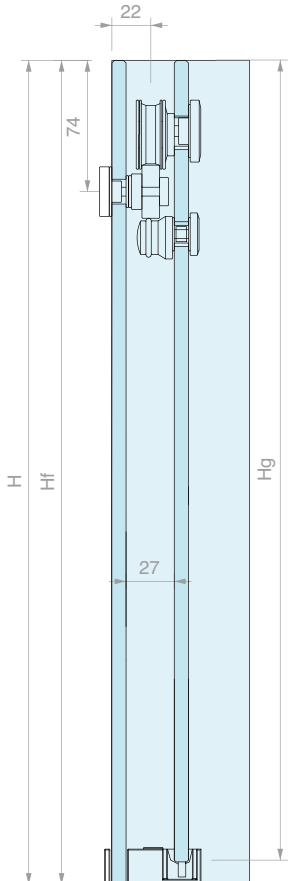

GLASS PANE DIMENSIONS

$L_g = (LV + 7) / 2$   
 $L_f = L_g$

$H_g = H - 10$   
 $H_f = H - 1$

$L_l = P - 2$   
 $H_l = H - 1$

$LA = (LV - 122) / 2$

PRIMARY LENGTHS (mm)

LV	Lg	Lf	LA
1500	504	504	689
1400	704	704	643
1300	654	654	589
1200	604	604	543

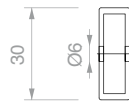

TRACK PROCESSING

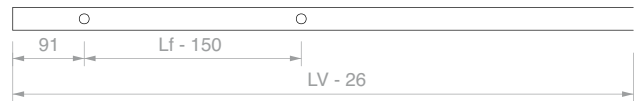

CLOSED SLIDING DOOR CONFIGURATION

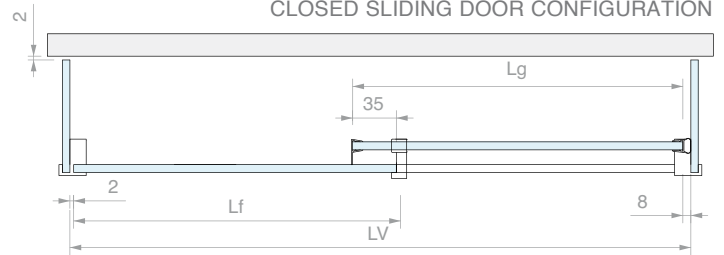

OPEN SLIDING DOOR CONFIGURATION

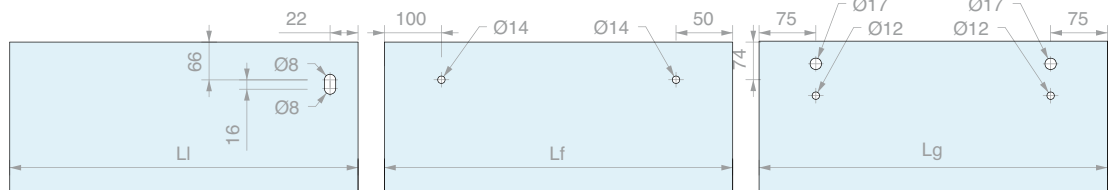
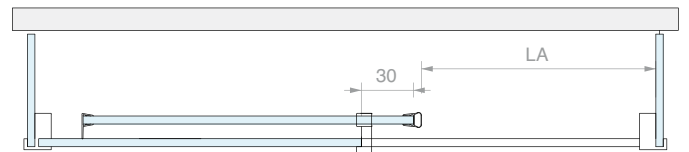

Art.	Description	Qty
<b>GLMFLAT040SX</b>	Towards left	1 Pc
<b>GLMFLAT040DX</b>	Towards right	1 Pc





**WALL/CORNER/WALL SLIDING DOOR SHOWER KIT FOR SEALED FIXED PANES**

Finish: /8 /15

Handle to be ordered separately

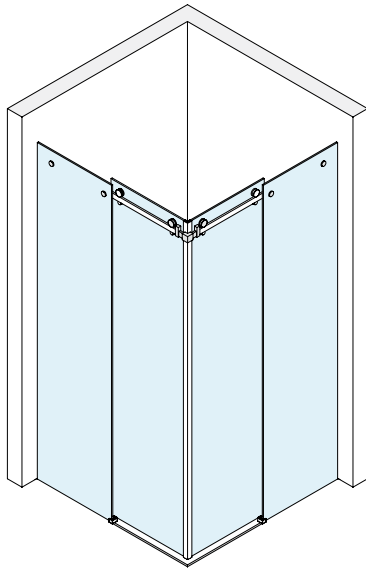

RECOMMENDED LAYOUTS

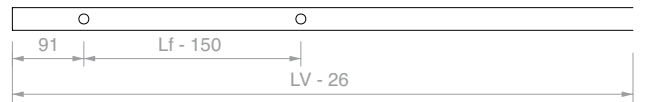
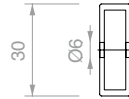
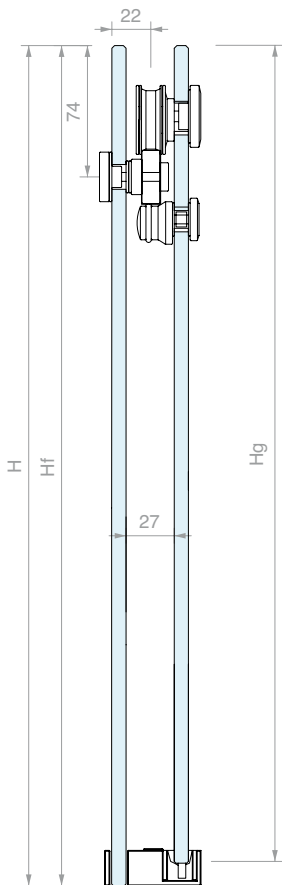

CLOSED SLIDING DOOR CONFIGURATION

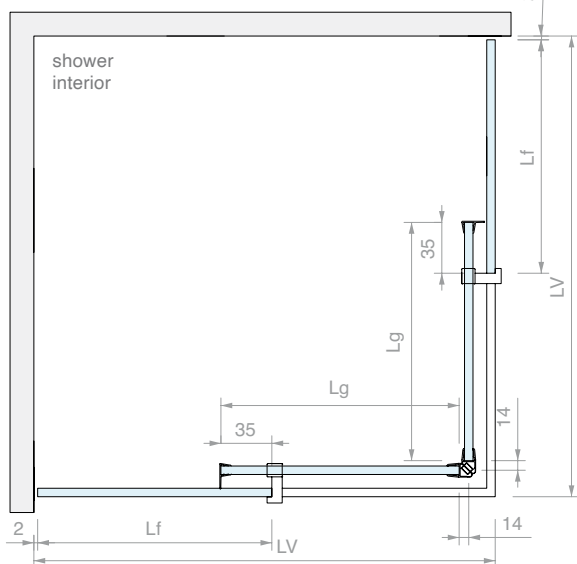

OPEN SLIDING DOOR CONFIGURATION

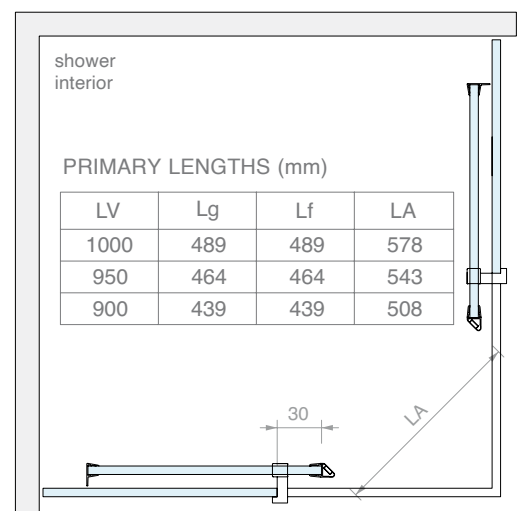

PRIMARY LENGTHS (mm)

LV	Lg	Lf	LA
1000	489	489	578
950	464	464	543
900	439	439	508

GLASS PANE DIMENSIONS

$Lg = (LV - 22) / 2$   
 $Lf = Lg$   
 $Hg = H - 10$   
 $Hf = H - 1$   
 $LA = 0.7 \times (LV - 122)$

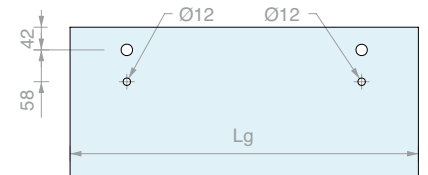
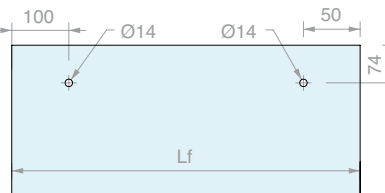

Art. **GLMFLAT036**

Qty  
1 Pc

Kit comprising:

Art.	Description	Qty	
<b>GLMFT12</b>	Sliding wheel	4 Pcs	
<b>GLMFT14</b>	Eccentric anti-derailment wheel	4 Pcs	
<b>GLMFT16</b>	Fixing for fixed glass	4 Pcs	
<b>GLMFT18</b>	Wall fixing	2 Pcs	
<b>GLMFT90</b>	Corner fixing	1 Pc	
<b>DCCFT20</b>	End stop	4 Pcs	
<b>BDFIX2-SX</b>	Floor guide, left	1 Pc	
<b>BDFIX2-DX</b>	Floor guide, right	1 Pc	
<b>GLMFT1000</b>	Track	2 Pcs	
<b>BDFIX8</b>	Water barrier profile	1 Pc	
<b>GM5610</b>	Gasket with drip flap	1 Pc	
<b>GM01422</b>	Gasket with side lip	2 Pcs	
<b>GM62SX</b>	45° magnetic gasket	1 Pc	
<b>GM62DX</b>	45° magnetic gasket	1 Pc	

Optional

<b>GLMSFORO</b>	Cutting and drilling	1 Pc	
-----------------	----------------------	------	--



**WALL/WALL ACCESSORIES KIT**

composed of:  
 2 sliding wheels  
 2 eccentric anti-derailment pins  
 2 fixings for fixed panes  
 2 wall fixings  
 2 end stops  
 Finish: /8 /15

Art.	For glass	Qty
<b>GLMFLATMUR</b>	8 mm	1 Pc



**WALL/GLASS ACCESSORIES KIT**

composed of:  
 2 sliding wheels  
 2 eccentric anti-derailment pins  
 2 fixings for fixed panes  
 1 wall fixing  
 1 glass fixing  
 2 end stops  
 Finish: /8 /15

Art.	For glass	Qty
<b>GLMFLATVET</b>	8 mm	1 Pc



**TRACK**

Material: AISI 304 steel  
 Finish: /8 /15

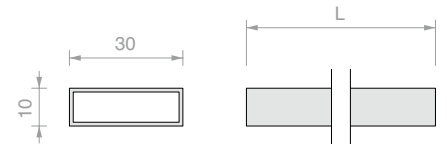

Art.	Length	Qty
<b>GLMFT1000</b>	1000 mm	1 Pc
<b>GLMFT2000</b>	2000 mm	1 Pc
<b>GLMFT3000</b>	3000 mm	1 Pc
<b>GLMSFORO</b>	Track cutting and drilling of 2 holes	1 Pc



**SLIDING WHEEL**

Material: AISI 304 steel  
 Finish: /8 /15  
 Recommended glass hole size Ø17 mm

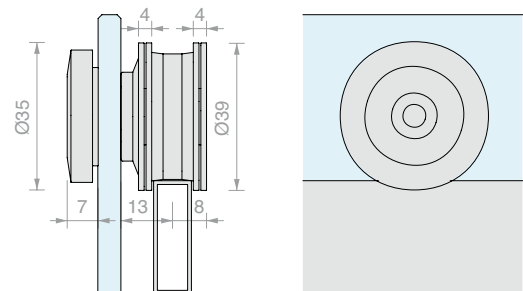

Art.	For glass	Qty
<b>GLMFT12</b>	8 mm	1 Pc



**ECCENTRIC ANTI-DERAILMENT PIN**

Material: AISI 304 steel

Finish: /8 /15

Recommended glass hole size Ø12 mm

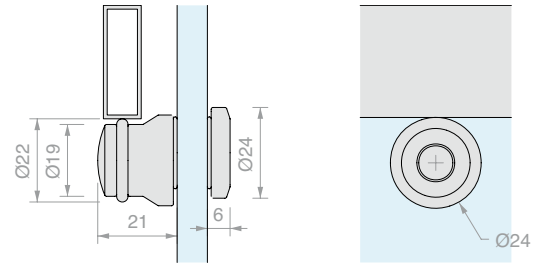

Art.	For glass	Qty
<b>GLMFT14</b>	8 mm	1 Pc



**FIXING FOR FIXED GLASS**

Material: AISI 304 steel

Finish: /8 /15

Recommended glass hole size Ø14 mm

Recommended track hole size Ø6 mm

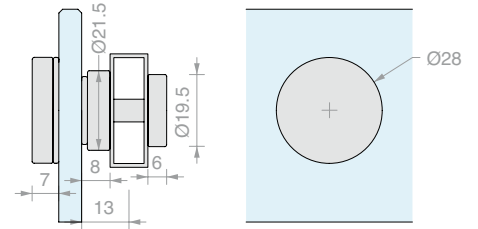

Art.	For glass	Qty
<b>GLMFT16</b>	8 mm	1 Pc



**FIXING FOR FIXED GLASS WITH CONNECTOR**

Material: AISI 304 steel

Finish: /8 /15

Recommended glass hole size Ø14 mm

Recommended track hole size Ø6 mm

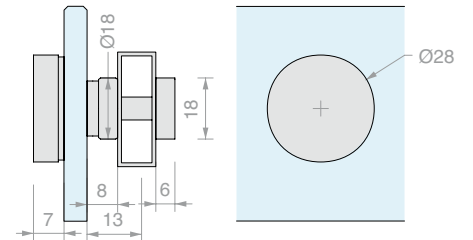

Art.	For glass	Qty
<b>GLMFT26</b>	8 mm	1 Pc



**WALL FIXING**

Material: AISI 304 steel

Finish: /8 /15

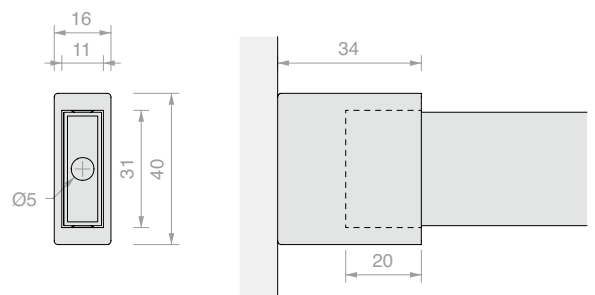

Art.	Qty
<b>GLMFT18</b>	1 Pc



**END STOP WITH RUBBER BUMPER**

Material: AISI 304 steel

Finish: /8 /15

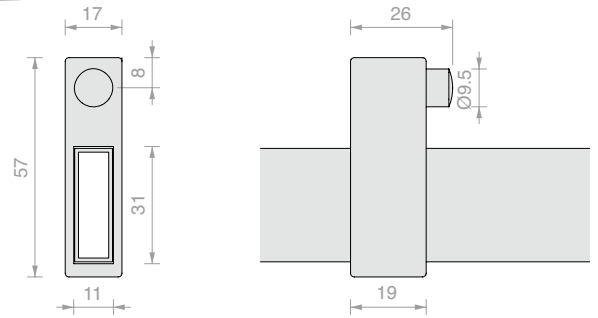

Art.

**DCCFT20**

Qty

1 Pc



**GLASS FIXING**

Material: AISI 304 steel

Finish: /8 /15

Recommended glass hole size Ø8 mm

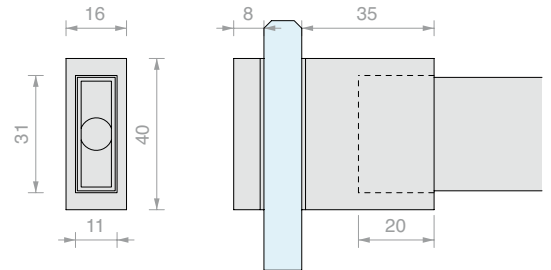

Art.

**GLMFT37**

For glass

From 8 to 10 mm

Qty

1 Pc



**CORNER JUNCTION**

Material: AISI 304 steel

Finish: /8 /15

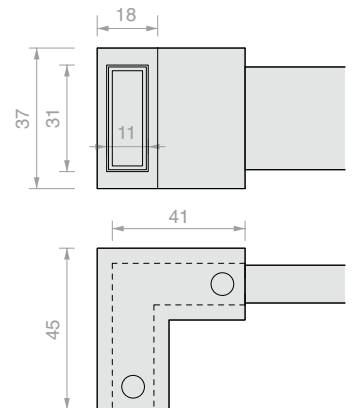

Art.

**GLMFT90**

Qty

1 Pc



**T-SHAPED CONNECTOR**

Material: AISI 304 steel

Finish: /8

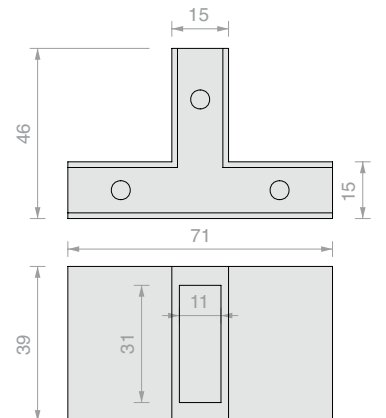

Art.

**PG03**

Qty

1 Pc





**GLASS-THROUGH FIXING**

Material: AISI 304 steel

Finish: /8

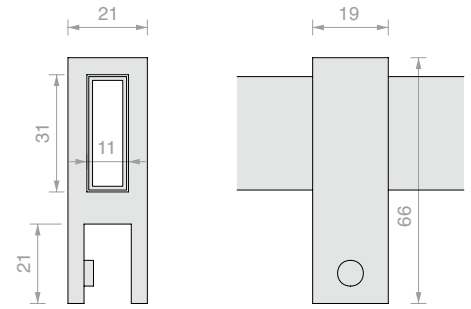

Art.	For glass	Qty
<b>PG05</b>	From 8 to 10 mm	1 Pc



**ADJUSTABLE FOOT SQUARE**

Material: AISI 304 steel

Finish: /8

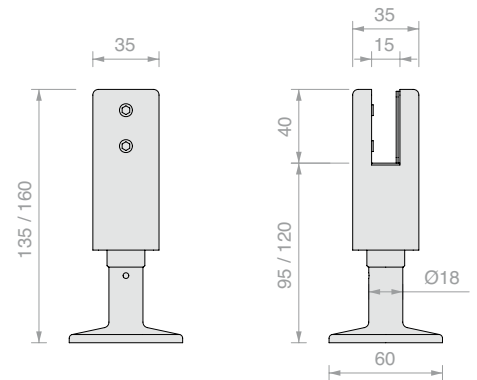

Art.	For glass	Qty
<b>PQ95</b>	From 8 to 12 mm	1 Pc



**ADJUSTABLE FOOT**

Material: AISI 304 steel

Finish: /8

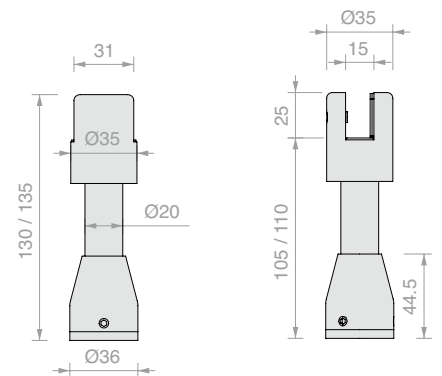

Art.	For glass	Qty
<b>PT105110</b>	From 8 to 12 mm	1 Pc



**DISTANCED GLASS-THROUGH FIXING**

Material: AISI 304 steel

Finish: /8 /15

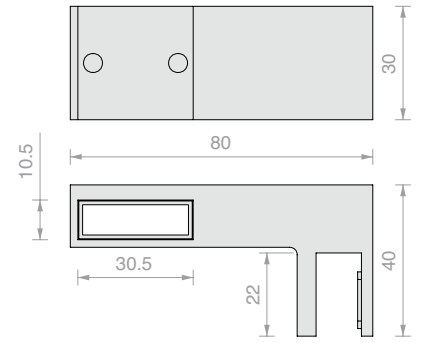

Art.	For glass	Qty
<b>GLMFT40</b>	From 8 to 10 mm	1 Pc



**WALL FIXING**

Material: AISI 304 steel

Finish: /8 /15

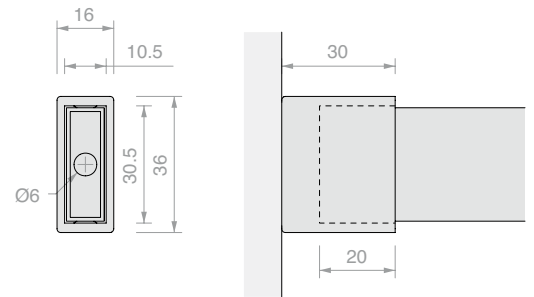

Art.	Qty
<b>GLMFT30</b>	1 Pc



**CLOSED GLASS FIXING**

Material: AISI 304 steel

Finish: /8 /15

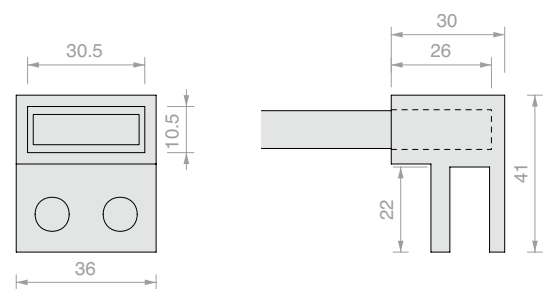

Art.	For glass	Qty
<b>GLMFT50</b>	From 8 to 10 mm	1 Pc



**SNAP-ON FLOOR GUIDE FOR GLASS WITH PROFILE**

Material: Zamak

Compatible with aluminium profiles in the PBD and LMU series

Finish: /1 /24

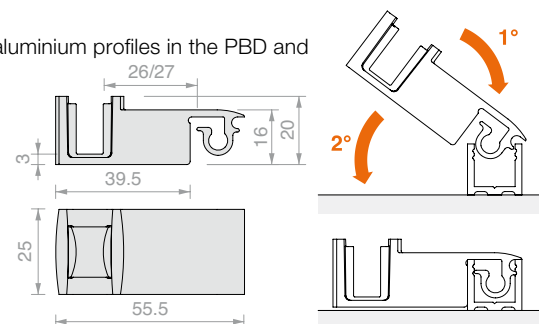

Art.	For glass	Qty
<b>DCC08</b>	8 mm	1 Pc
<b>DCC10</b>	10 mm	1 Pc

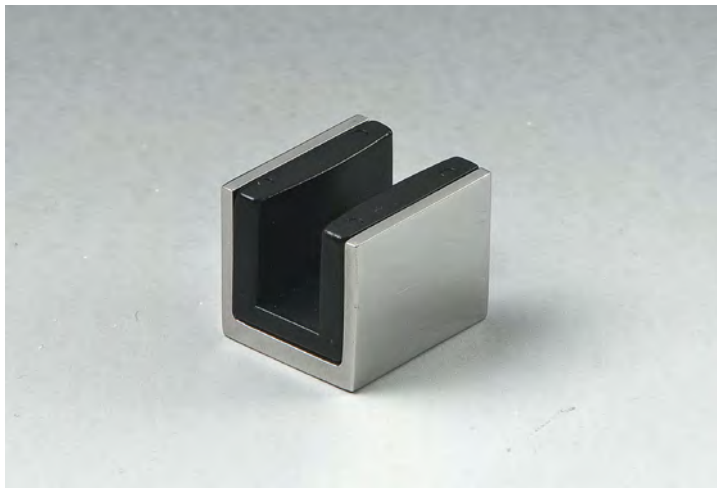

**FLOOR GUIDE**

Material: AISI 304 steel

Finish: /8 /15

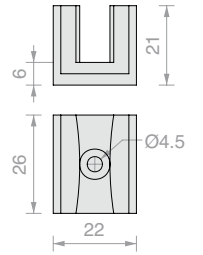

Art.	For glass	Qty
<b>GLMSPA06</b>	6 mm	1 Pc
<b>GLMSPA08</b>	8 mm	1 Pc
<b>GLMSPA10</b>	10 mm	1 Pc

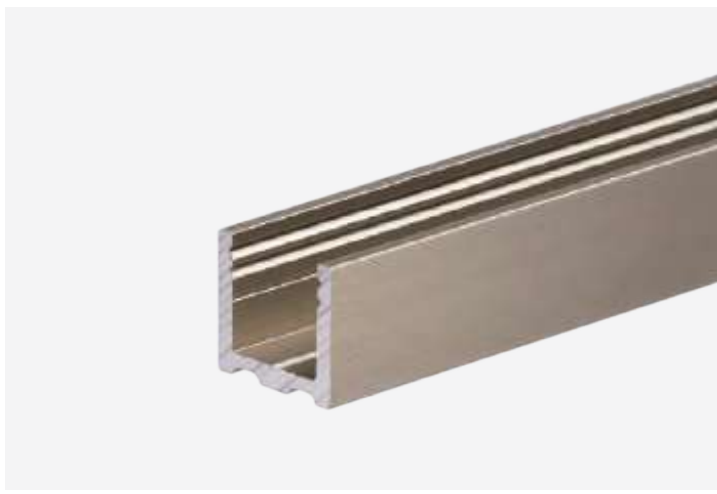

**U-SHAPED PROFILE**

Material: Aluminium

Finish: /6 /88 /91 /97

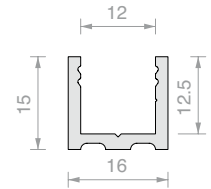

Art.	Length	Qty
<b>PBD3183.150</b>	1498 mm	1 Pc
<b>PBD3183.220</b>	2200 mm	1 Pc
<b>PBD3183</b>	3000 mm	1 Pc



**ROUNDED UPPER PROFILE PBD3184**

Material: Aluminium

Finish: /6 /88 /91 /97

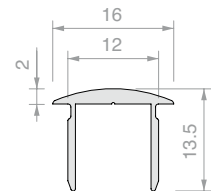

Art.	Length	Qty
<b>PBD3184.100</b>	992 mm	1 Pc
<b>PBD3184.150</b>	1498 mm	1 Pc
<b>PBD3184</b>	3000 mm	1 Pc



**ROUNDED CAP PBD**

Material: Aluminium

Finish: /6 /88 /91 /97

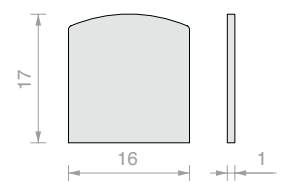

Art.	Qty
<b>PBDTP</b>	1 Pc



**FLAT UPPER PROFILE PBD3186**

Material: Aluminium

Finish: /6 /88 /91 /97

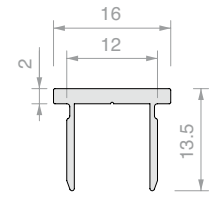

Art.	Length	Qty
<b>PBD3186.100</b>	992 mm	1 Pc
<b>PBD3186.150</b>	1498 mm	1 Pc
<b>PBD3186</b>	3000 mm	1 Pc



**PBD FLAT CAP**

Material: Aluminium

Finish: /6 /88 /91 /97

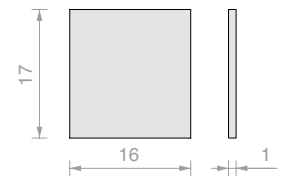

Art.	Qty
<b>PBD86TP</b>	1 Pc



**CORNER JOINT FOR PROFILE**

Material: Zamak

Compatible with aluminium profiles in the PBD and LMU series

For PBD3184 upper profile

Finish: /1 /6 /24 /97

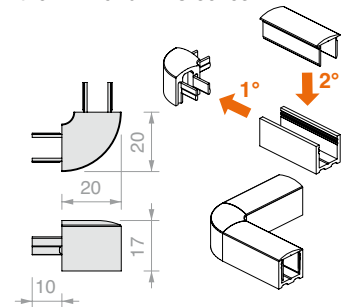

Art.	Qty
<b>DCC90</b>	1 Pc



**FLAT CORNER JOINT FOR PROFILE**

Material: Zamak

Compatible with aluminium profiles in the PBD and LMU series

For PBD3186 upper profile

Finish: /1 /6 /24 /97

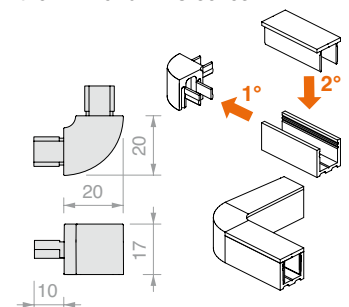

Art.	Qty
<b>DCC90SQ</b>	1 Pc

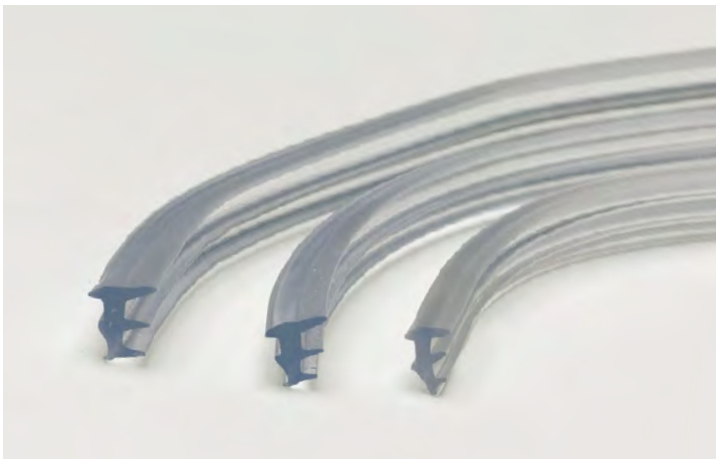

**GLASS HOLDER GASKET**

Material: PVC

Art.	Thickness	Colour	Qty	Art.	Thickness	Colour	Qty	Art.	Thickness	Colour	Qty
<b>GTUP2</b>	2 mm	Transparent	1 m	<b>GTUP2G</b>	2 mm	Embossed	1 m	<b>GTUP2N</b>	2 mm	Black	1 m
<b>GTUP3</b>	3 mm	Transparent	1 m	<b>GTUP3G</b>	3 mm	Embossed	1 m	<b>GTUP3N</b>	3 mm	Black	1 m
<b>GTUP4</b>	4 mm	Transparent	1 m	<b>GTUP4G</b>	4 mm	Embossed	1 m	<b>GTUP4N</b>	4 mm	Black	1 m
<b>GTUP5</b>	5 mm	Transparent	1 m	<b>GTUP5G</b>	5 mm	Embossed	1 m	<b>GTUP5N</b>	5 mm	Black	1 m
<b>GTUP6</b>	6 mm	Transparent	1 m	<b>GTUP6G</b>	6 mm	Embossed	1 m	<b>GTUP6N</b>	6 mm	Black	1 m



**FLOOR GUIDE, WALL SIDE**

Material: AISI 304 steel

Finish: /8 /15

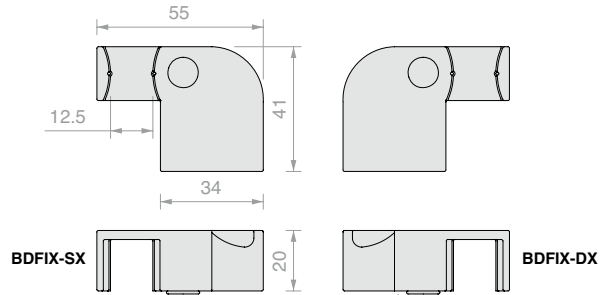

Art.	Description	Qty
<b>BDFIX-SX</b>	Left	1 Pc
<b>BDFIX-DX</b>	Right	1 Pc



**FLOOR GUIDE, FIXED GLASS SIDE**

Material: AISI 304 steel

Finish: /8 /15

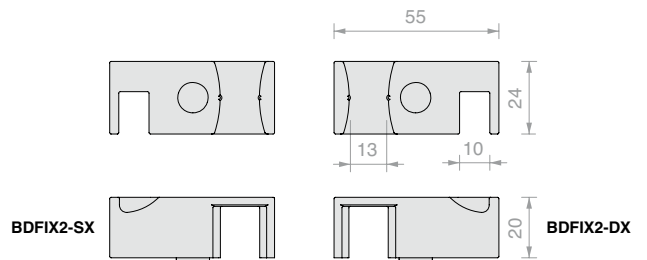

Art.	Description	Qty
<b>BDFIX2-SX</b>	Left	1 Pc
<b>BDFIX2-DX</b>	Right	1 Pc



**FLOOR GUIDE, EDGE SIDE GLASS**

Material: AISI 304 steel

Finish: /8 /15

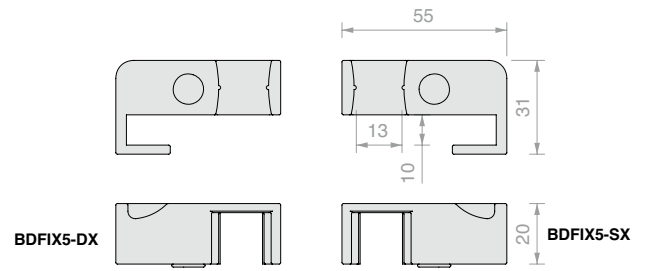

Art.	Description	Qty
<b>BDFIX5-SX</b>	Left	1 Pc
<b>BDFIX5-DX</b>	Right	1 Pc



**FLOOR GUIDE, FIXED GLASS SIDE**

Material: AISI 304 steel

Finish: /8 /15

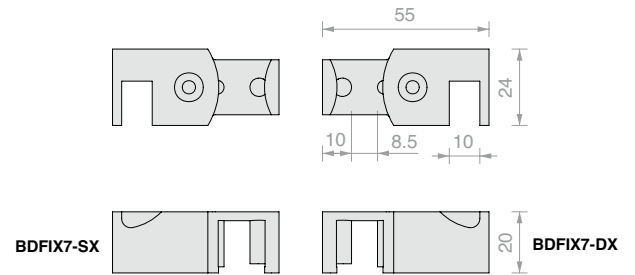

Art.	Description	For glass	Qty
<b>BDFIX7-SX</b>	Left	8 mm	1 Pc
<b>BDFIX7-DX</b>	Right	8 mm	1 Pc

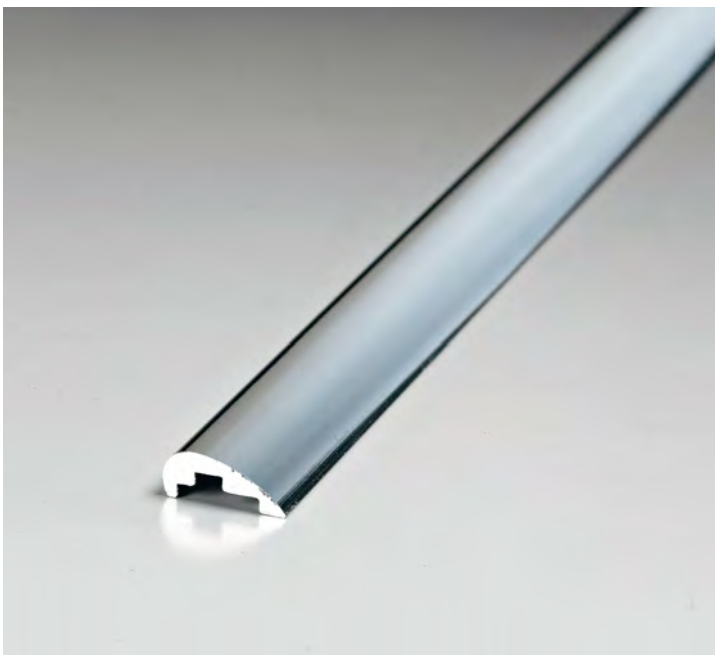

**BDFIX WATER BARRIER PROFILE**

Material: Aluminium

Finish: /91

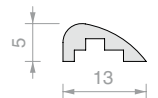

Art.	Length	Qty
<b>BDFIX8</b>	2000 mm	1 Pc
<b>BDFIX10</b>	1000 mm	1 Pc



### MAGNETIC 45° GASKET

Material: Co-extruded rigid and soft PVC  
Resistant to UV rays  
Fungicide to prevent mould from forming  
Maximum operating temperature 70°C  
Colour: transparent balloon,  
white magnet

Art.	Length	For glass	Qty
<b>GM62SX</b>	2200 mm	From 6 to 8 mm	1 Pc
<b>GM6230SX</b>	3000 mm	From 6 to 8 mm	1 Pc
<b>GM62DX</b>	2200 mm	From 6 to 8 mm	1 Pc
<b>GM6230DX</b>	3000 mm	From 6 to 8 mm	1 Pc

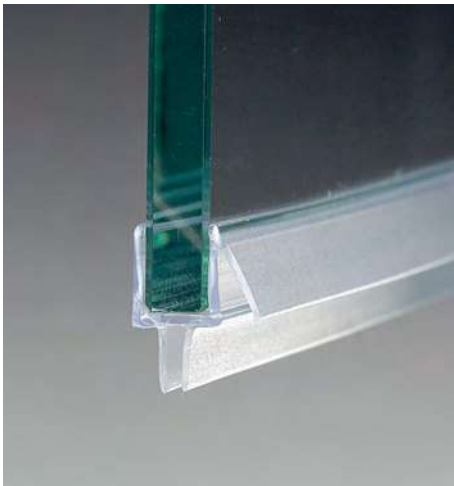
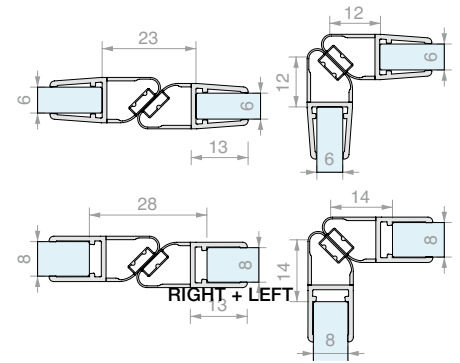

### GASKET WITH DOUBLE-LIP WATER BARRIER AND DRIP FLAP

Material: Co-extruded rigid and soft PVC  
Resistant to UV rays  
Fungicide to prevent mould from forming  
Maximum operating temperature 70°C  
Colour: transparent, embossed lips

Art.	Length	For glass	Qty
<b>GM5610</b>	1000 mm	From 6 to 8 mm	1 Pc
<b>GM5620</b>	2000 mm	From 6 to 8 mm	1 Pc
<b>GM5625</b>	2500 mm	From 6 to 8 mm	1 Pc
<b>GM5630</b>	3000 mm	From 6 to 8 mm	1 Pc

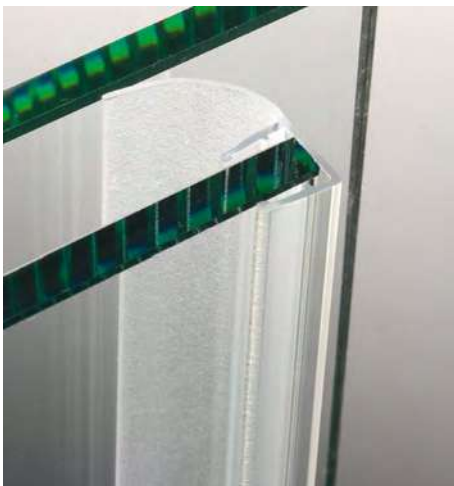
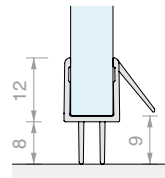

### GASKET WITH LONG SIDE LIP

Material: Co-extruded rigid and soft PVC  
Resistant to UV rays  
Fungicide to prevent mould from forming  
Colour: transparent/\*black, embossed lip

Art.	Length	For glass	Qty
<b>GM014</b>	2000 mm	From 8 to 10 mm	1 Pc
<b>GM01422</b>	2200 mm	From 8 to 10 mm	1 Pc
<b>GM01422NR*</b>	2200 mm	From 8 to 10 mm	1 Pc
<b>GM01425</b>	2500 mm	From 8 to 10 mm	1 Pc
<b>GM01425NR*</b>	2500 mm	From 8 to 10 mm	1 Pc
<b>GM0143000</b>	3000 mm	From 8 to 10 mm	1 Pc
<b>GM0143000NR*</b>	3000 mm	From 8 to 10 mm	1 Pc

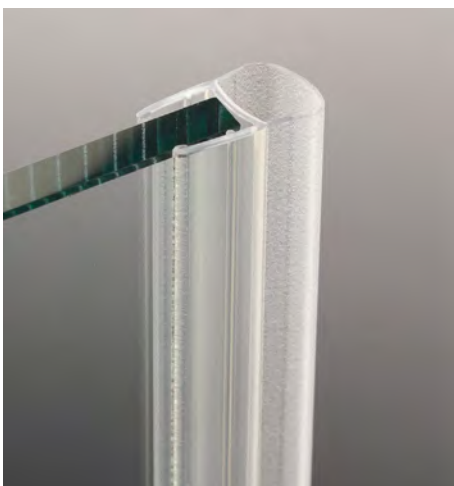
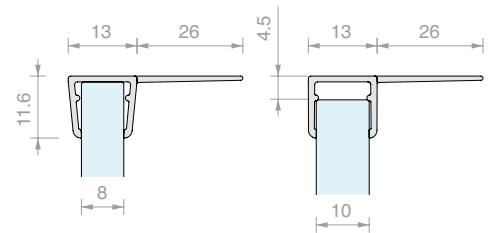

### BALLOON GASKET

Material: Co-extruded rigid and soft PVC  
Maximum operating temperature 70°C  
Colour: transparent/\*black, transparent balloon

Art.	Length	For glass	Qty
<b>GM06</b>	2000 mm	From 8 to 10 mm	1 Pc
<b>GM0622</b>	2200 mm	From 8 to 10 mm	1 Pc
<b>GM0622NR*</b>	2200 mm	From 8 to 10 mm	1 Pc
<b>GM0625</b>	2500 mm	From 8 to 10 mm	1 Pc
<b>GM0625NR*</b>	2500 mm	From 8 to 10 mm	1 Pc
<b>GM063000</b>	3000 mm	From 8 to 10 mm	1 Pc
<b>GM063000NR*</b>	3000 mm	From 8 to 10 mm	1 Pc

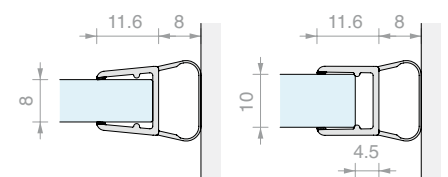

# DCCFLAT

## *Design*

The elegance of steel combines with the transparency of glass.  
The DCCFLAT system offers long-lasting performance and an  
even more sophisticated design.







**/8**  
Brushed steel

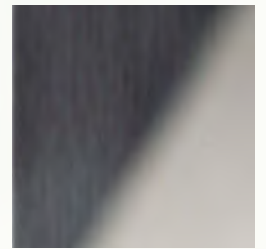

**/15**  
Polished steel



# DCCFLAT

## Technical properties

Sliding door system for 8-mm glass with visible mechanisms. Featuring easy assembly and adjustment, this elegant and functional solution supports doors weighing up to 35 kg. Innovative technical solutions minimize the number of visible components, without ever overlooking the functional features of a top-of-the-line system.

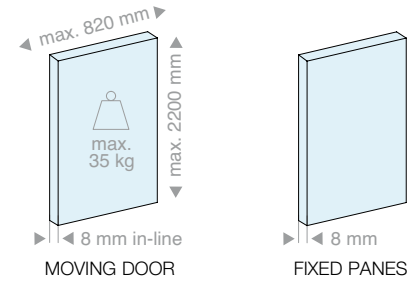

### 4 configurations

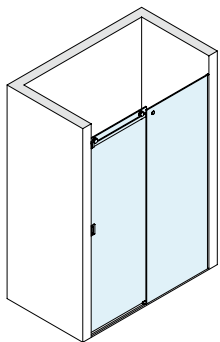

Wall/Wall

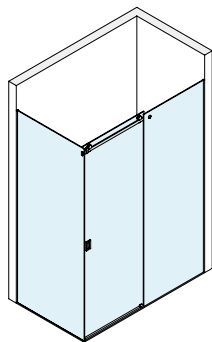

Wall/Glass

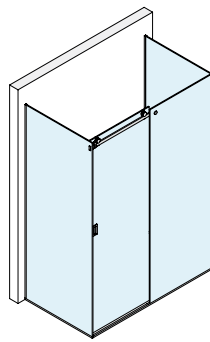

Glass/Glass

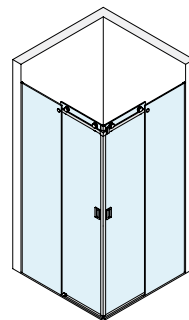

Wall/Corner/Wall

### Types of installation

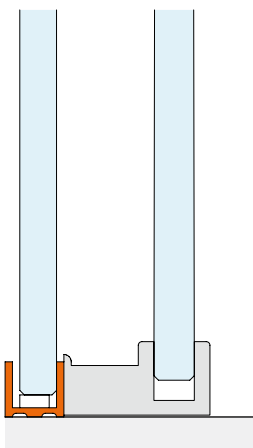
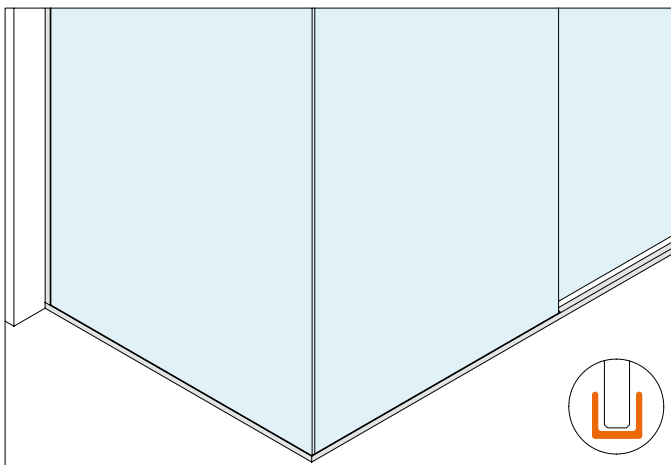

#### Kits

*For framed fixed panes*

Simple, modern design.  
With this solution, fixed glass panes are installed within a 15mm x 16mm aluminium profile. The same profile, with an upper snap-on cover, acts as a water barrier in the open area.

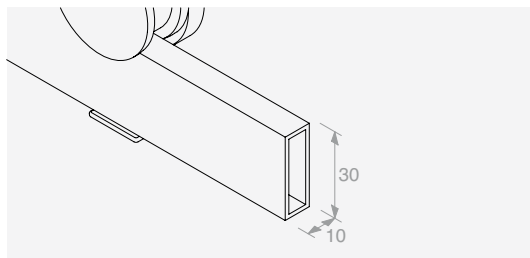
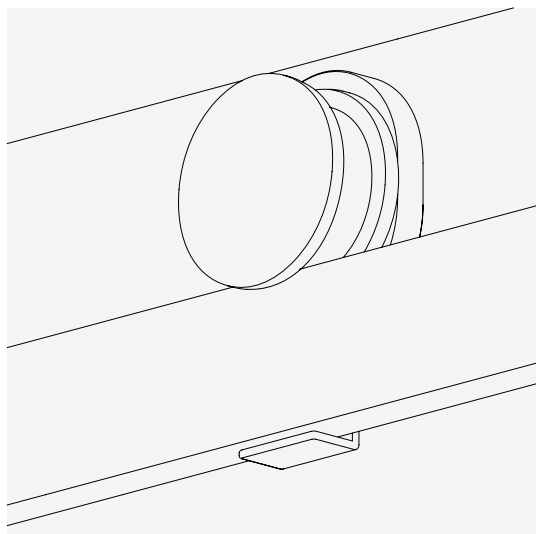

### MINIMAL DESIGN

The design combines essential aesthetics and functional elegance

### STABILISATION

The anti-derailment system is incorporated in the carrier, minimising the number of visible components

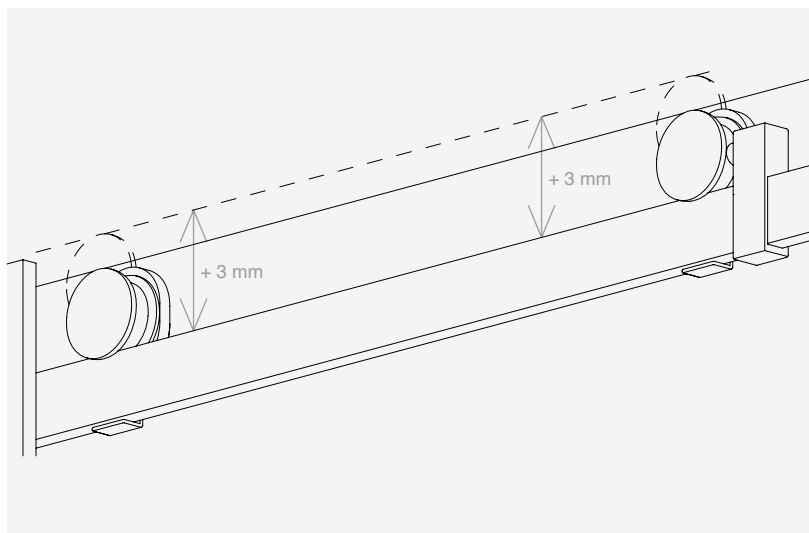
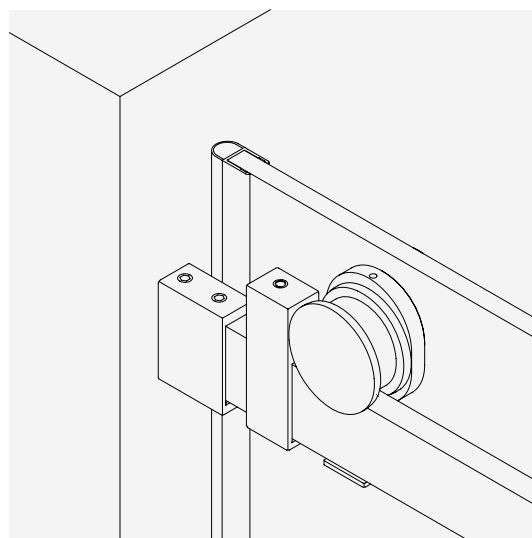

### VISIBLE MECHANISMS

The simple and discreet functional components featuring external sliding wheels make the glass stand out.

### ADJUSTMENT

The height regulation of the carriers using a hidden set screw allows for simple and precise adjustments.

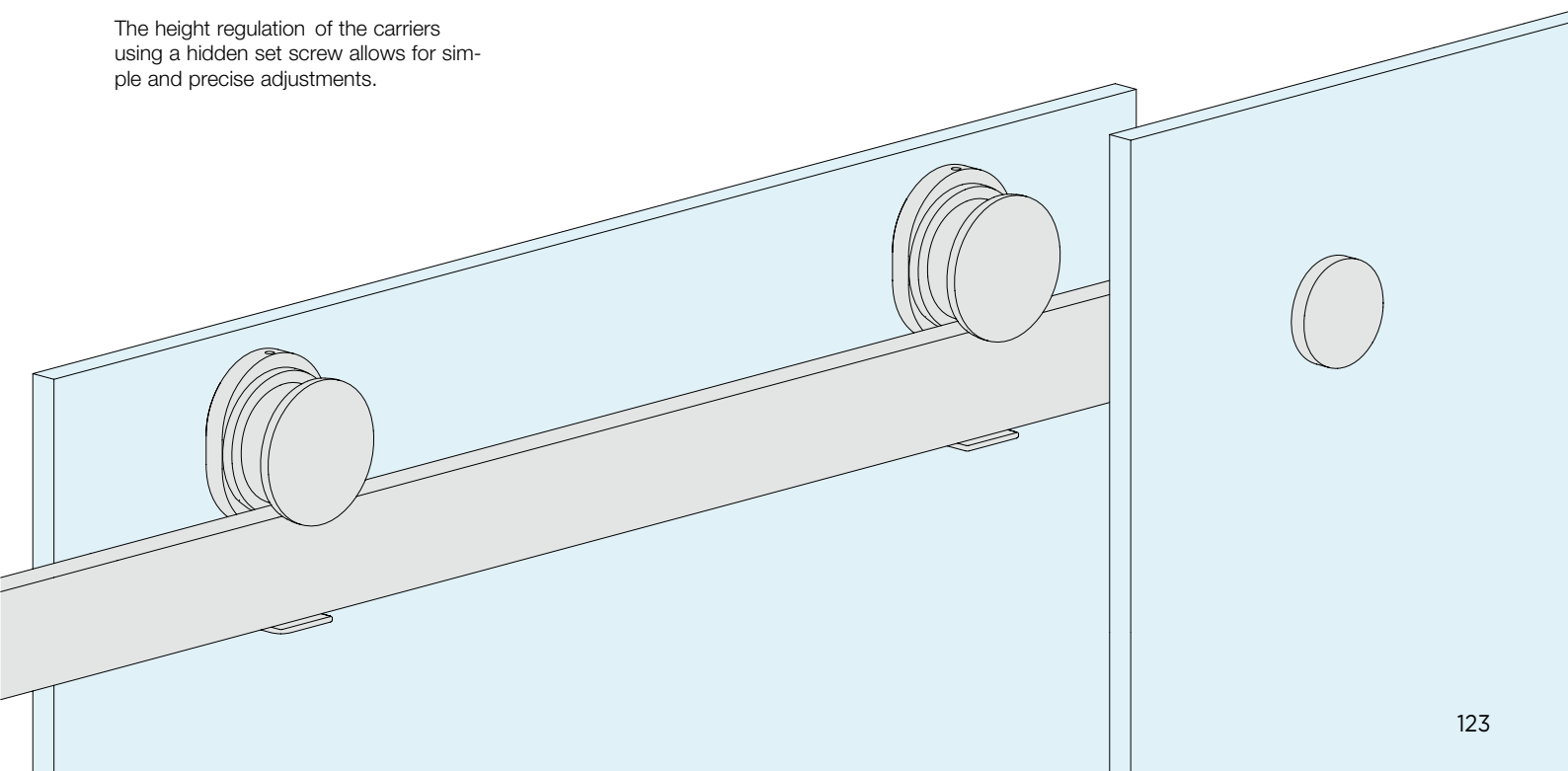



# DCCFLAT

*Kit*



## CONFIGURATIONS WITH FRAMED FIXED PANES

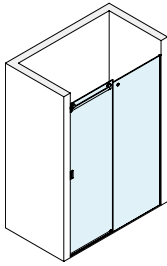

Page 127

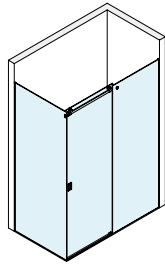

Page 129

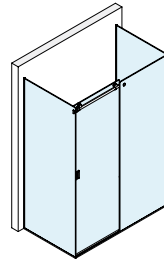

Page 131

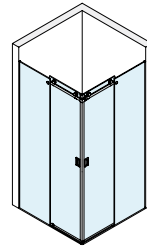

Page 133



**WALL/WALL SLIDING DOOR SHOWER KIT WITH FRAME PROFILE FOR FIXED PANE**

Finish: /8 /15

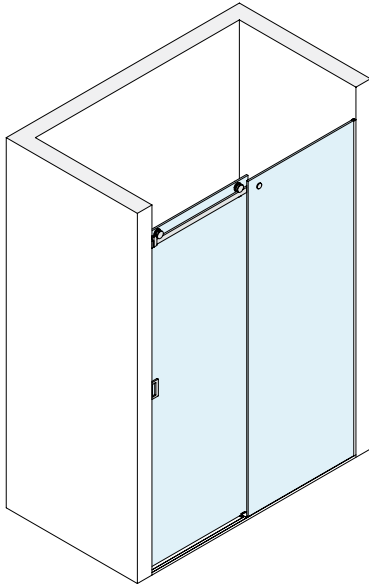

Kit comprising:

Art.	Description	Qty
<b>DCCFTMUR</b>	Wall/wall accessories kit	1 Pc
<b>GLMFT2000</b>	Track	1 Pc
<b>PBD3183.220</b>	U-shaped profile	2 Pcs
<b>PBD3184.150</b>	Rounded upper profile	1 Pc
<b>GTUP4</b>	Glass holder gasket	4 m
<b>GM01422</b>	Gasket with side lip	1 Pc
<b>GM0622</b>	Balloon gasket	1 Pc
<b>HAND10057VHB</b>	Adhesive handle	2 Pcs
Optional		
<b>GLMDCCFORO</b>	Cutting and drilling	1 Pc

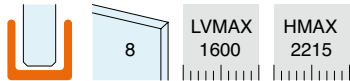
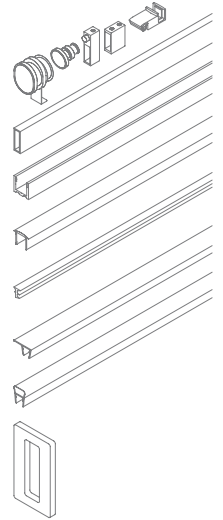

RECOMMENDED LAYOUTS

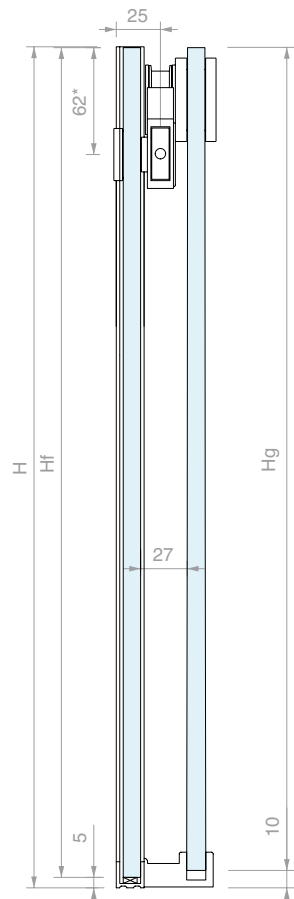

GLASS PANE DIMENSIONS

$L_g = (LV + 40) / 2$   
 $L_f = L_g - 20$

$H_g = H - 10$   
 $H_f = H - 5$

$LA = (LV - 120) / 2$

PRIMARY LENGTHS (mm)

LV	Lg	Lf	LA
1600	820	800	740
1500	770	750	690
1400	720	700	640
1300	670	650	590

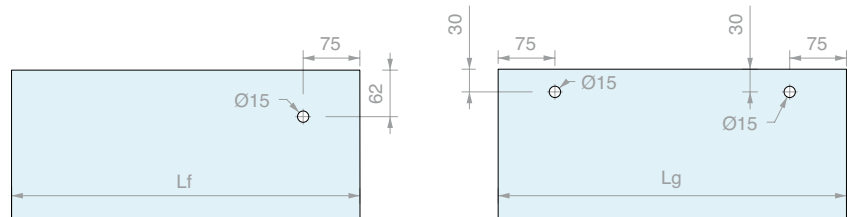
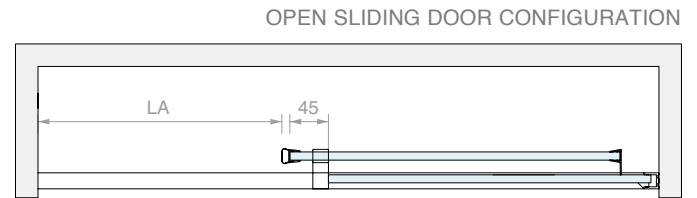
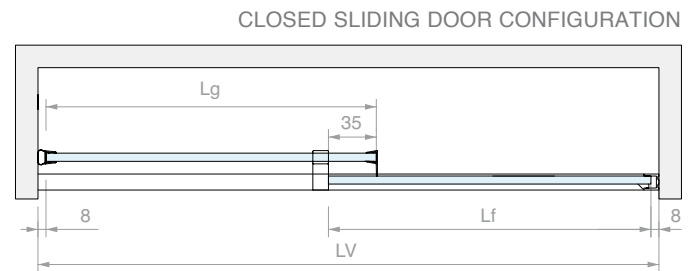
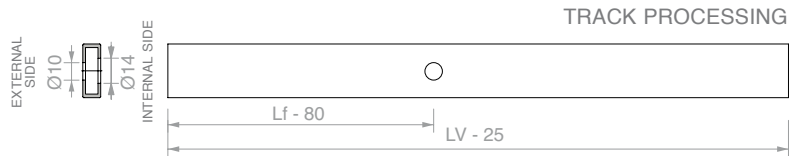

Art.  
**DCCFLAT003**

Qty  
1 Pc







**WALL/GLASS SLIDING DOOR SHOWER KIT WITH FRAME PROFILE FOR FIXED PANES**

Finish: /8 /15

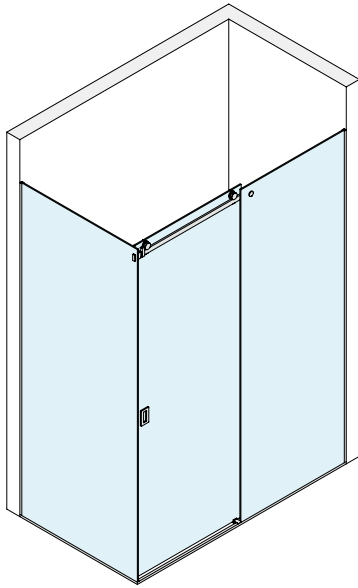

Kit comprising:

Art.	Description	Qty
<b>DCCFTVET</b>	Wall/glass accessories kit	1 Pc
<b>GLMFT2000</b>	Track	1 Pc
<b>PBD3183.220</b>	U-shaped profile	3 Pcs
<b>PBD3183.150</b>	U-shaped profile	1 Pc
<b>PBD3184.150</b>	Rounded upper profile	1 Pc
<b>GTUP4</b>	Glass holder gasket	7 m
<b>GM01422</b>	Gasket with side lip	1 Pc
<b>GM0622</b>	Balloon gasket	1 Pc
<b>HAND10057VHB</b>	Adhesive handle	2 Pcs
Optional		
<b>GLMDCCFORO</b>	Cutting and drilling	1 Pc

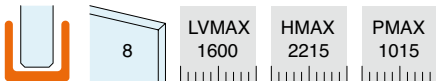
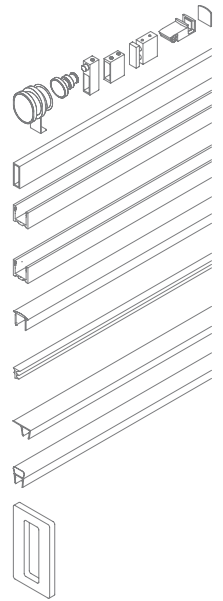

RECOMMENDED LAYOUTS

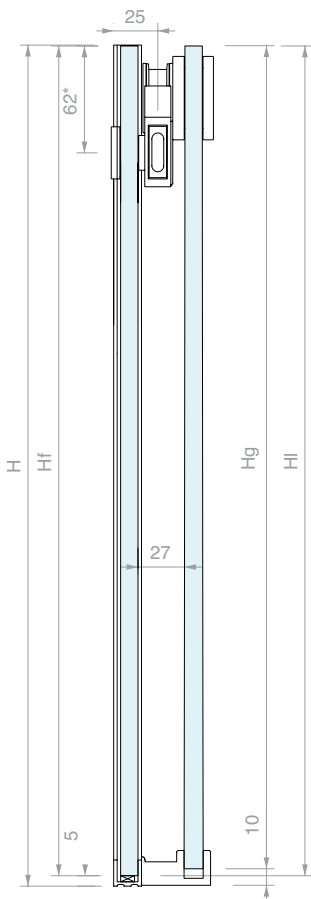

GLASS PANE DIMENSIONS

$L_g = (LV + 26) / 2$   
 $L_f = L_g - 20$

$H_g = H - 10$   
 $H_f = H - 5$

$L_l = P - 14$   
 $H_l = H - 5$   
 $LA = (LV - 134) / 2$

PRIMARY LENGTHS (mm)

LV	Lg	Lf	LA
1600	813	793	733
1500	763	743	683
1400	713	693	633
1300	663	643	583

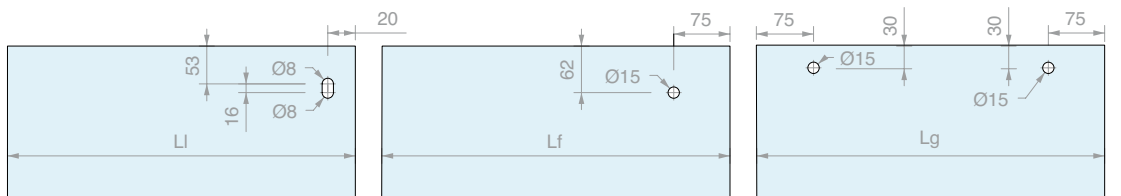
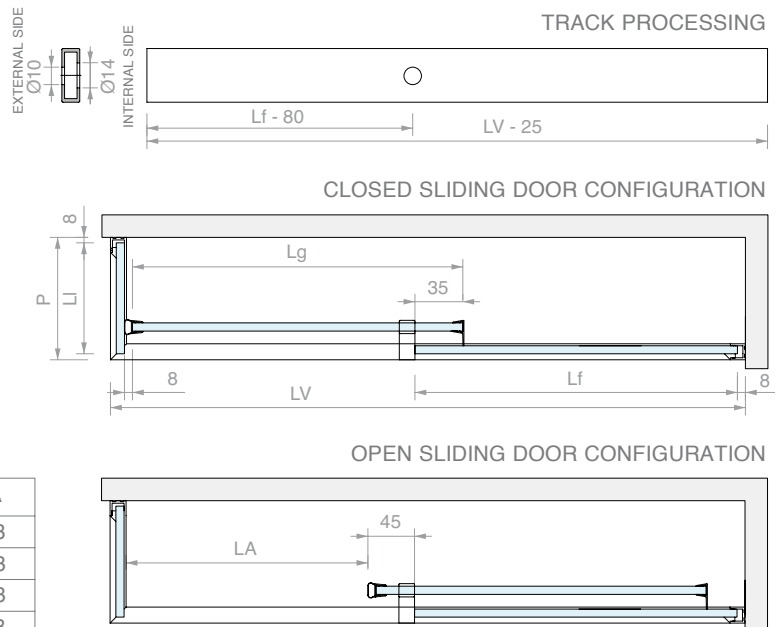

Art.  
**DCCFLAT007**

Qty  
1 Pc





**GLASS/GLASS SLIDING DOOR SHOWER KIT WITH FRAME PROFILE FOR FIXED PANES**

Finish: /8 /15

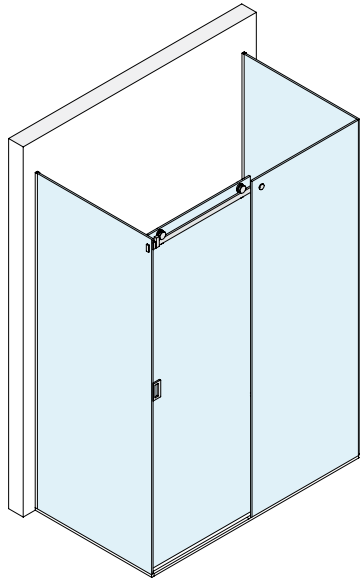

Kit comprising:

Art.	Description	Qty
<b>DCCFTVV</b>	Glass/glass accessories kit	1 Pc
<b>GLMFT2000</b>	Track	1 Pc
<b>PBD3183.220</b>	U-shaped profile	3 Pcs
<b>PBD3183.150</b>	U-shaped profile	2 Pcs
<b>PBD3184.150</b>	Rounded upper profile	1 Pc
<b>GTUP4</b>	Glass holder gasket	7 m
<b>GM01422</b>	Gasket with side lip	1 Pc
<b>GM0622</b>	Balloon gasket	1 Pc
<b>HAND10057VHB</b>	Adhesive handle	2 Pcs
Optional		
<b>GLMDCCFORO</b>	Cutting and drilling	1 Pc

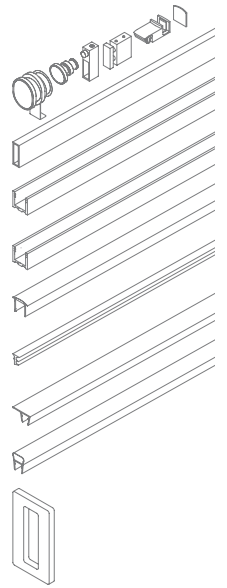

	<b>8</b>	<b>LVMAX</b> 1630	<b>HMAX</b> 2215	<b>PMAX</b> 1015
--	----------	----------------------	---------------------	---------------------

RECOMMENDED LAYOUTS

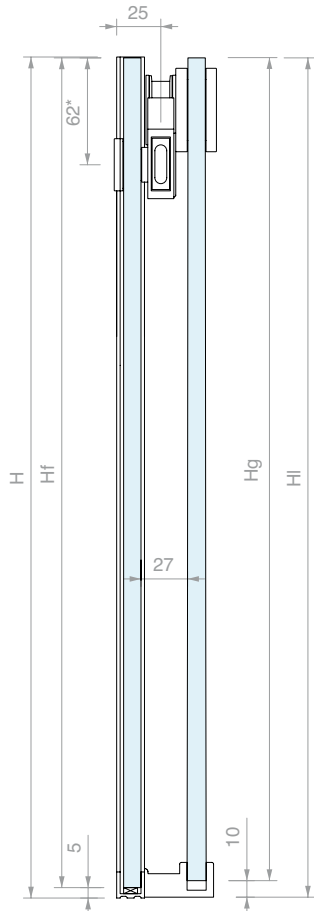

GLASS PANE DIMENSIONS

$L_g = (LV + 12) / 2$   
 $L_f = L_g - 20$

$H_g = H - 10$   
 $H_f = H - 5$

$L_i = P - 14$   
 $H_i = H - 5$   
 $LA = (LV - 148) / 2$

PRIMARY LENGTHS (mm)

LV	Lg	Lf	LA
1600	806	786	726
1500	756	736	676
1400	706	686	626
1300	656	636	576

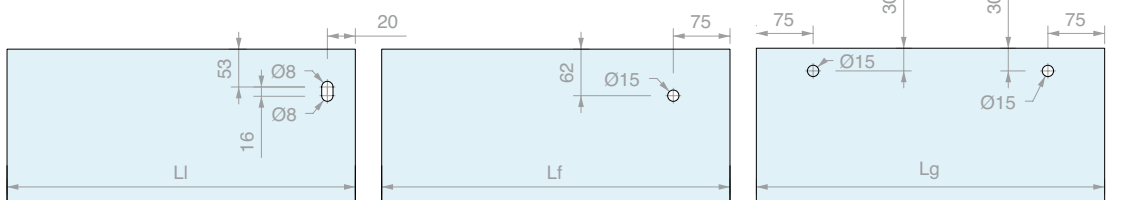
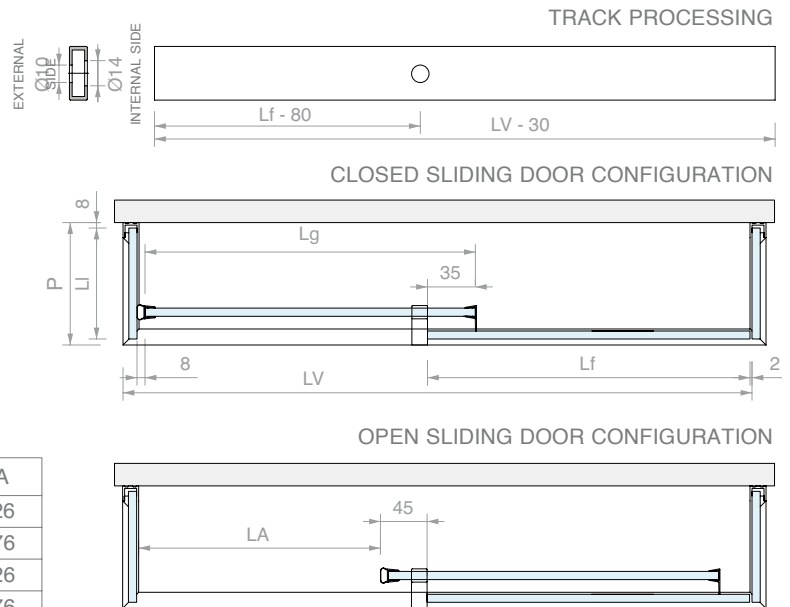

Art.  
**DCCFLAT009**

Qty  
1 Pc





**WALL/CORNER/WALL SLIDING DOOR SHOWER KIT WITH FRAME PROFILE FOR FIXED PANES**

Finish: /8 /15

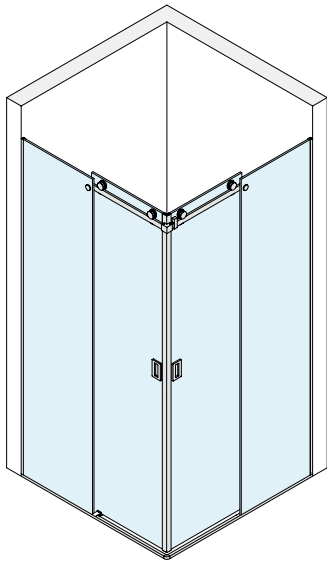

Kit comprising:

Art.	Description	Qty
<b>DCCFT90</b>	Wall/corner/wall accessories kit	1 Pc
<b>GLMFT1000</b>	Track	2 Pcs
<b>PBD3183.220</b>	U-shaped profile	2 Pcs
<b>PBD3183.150</b>	U-shaped profile	2 Pcs
<b>PBD3184.150</b>	Rounded upper profile	1 Pc
<b>GTUP4</b>	Glass holder gasket	7 m
<b>GM62SX</b>	45° magnetic gasket	1 Pc
<b>GM62DX</b>	45° magnetic gasket	1 Pc
<b>GM01422</b>	Gasket with side lip	2 Pcs
<b>HAND10057VHB</b>	Adhesive handle	4 Pcs
Optional		
<b>GLMDCCFORO</b>	Cutting and drilling	1 Pc

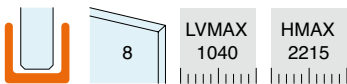
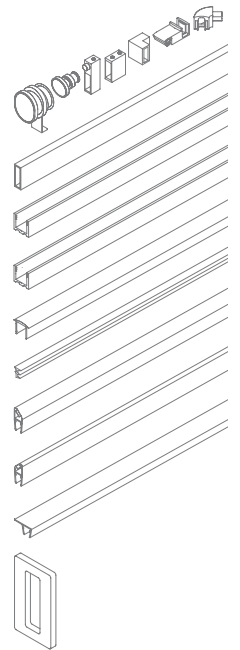

RECOMMENDED LAYOUTS

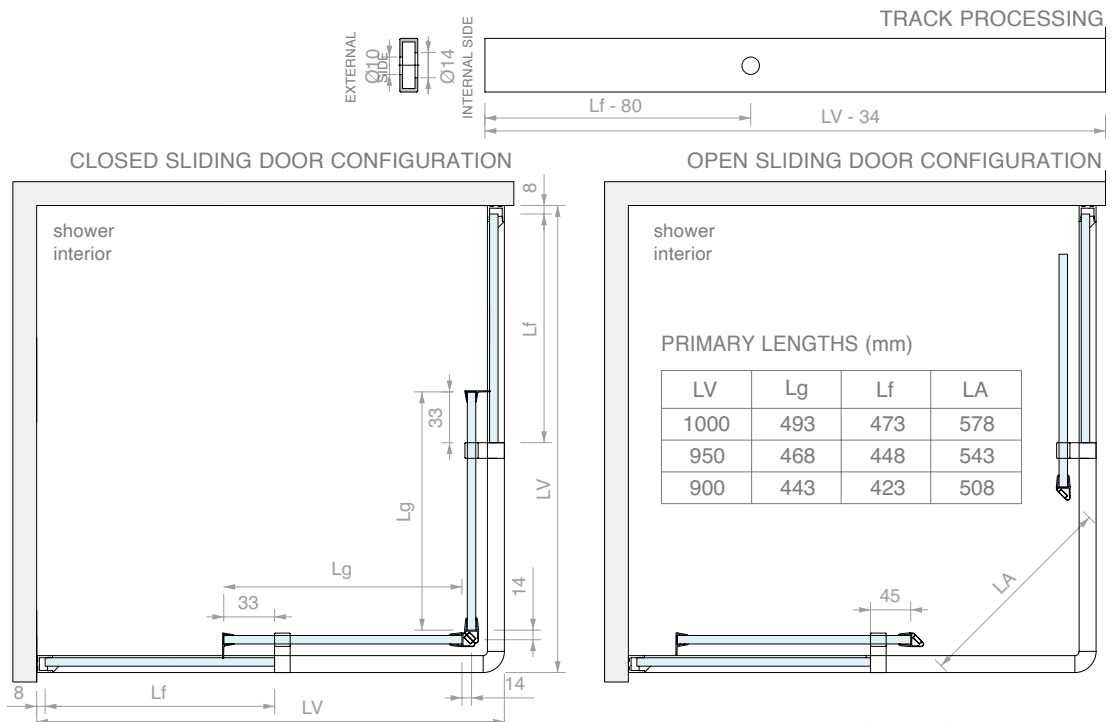
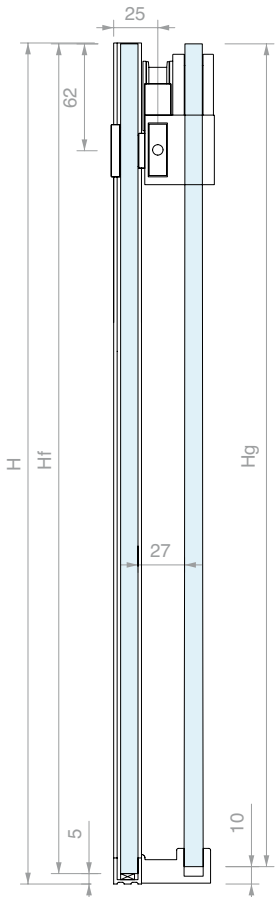

GLASS PANE DIMENSIONS

$Lg = (LV - 14) / 2$   
 $Lf = Lg$   
 $Hg = H - 10$   
 $Hf = H - 6$   
 $LA = 0.7 \times (LV - 174)$

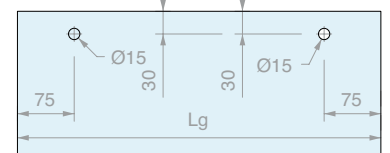
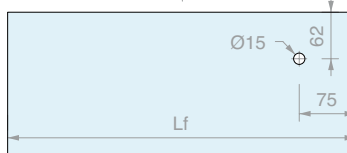

Art.  
**DCCFLAT011**

Qty  
1 Pc



**WALL/WALL ACCESSORIES KIT**

composed of:  
 2 eccentric sliding wheels with cover  
 2 wall fixings  
 2 end stops  
 1 fixing for fixed pane  
 1 floor guide  
 Finish: /8 /15

Art.	For glass	Qty
<b>DCCFTMUR</b>	8 mm	1 Pc



**WALL/GLASS ACCESSORIES KIT**

composed of:  
 2 eccentric sliding wheels with cover  
 1 wall fixing  
 1 glass fixing  
 2 end stops  
 1 fixing for fixed pane  
 1 floor guide  
 1 profile cap  
 Finish: /8 /15

Art.	For glass	Qty
<b>DCCFTVET</b>	8 mm	1 Pc



**GLASS/GLASS ACCESSORIES KIT**

composed of:  
 2 eccentric sliding wheels with cover  
 2 glass fixings  
 2 end stops  
 1 fixing for fixed pane  
 1 floor guide  
 2 profile caps  
 Finish: /8 /15

Art.	For glass	Qty
<b>DCCFTVW</b>	8 mm	1 Pc

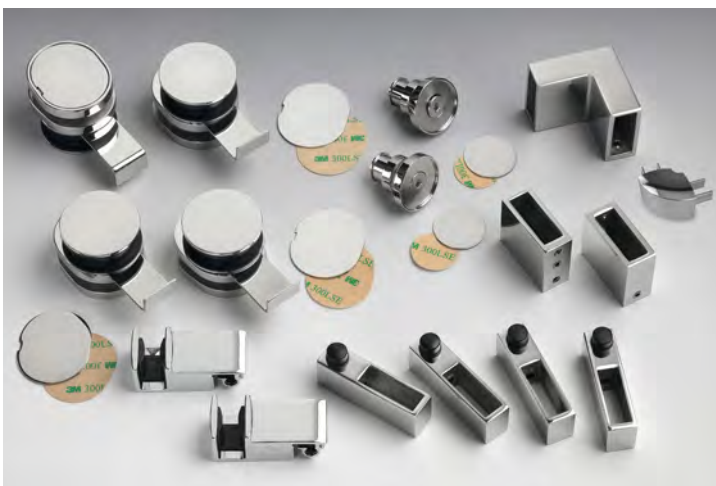

**WALL/CORNER/WALL ACCESSORIES KIT**

composed of:  
 4 eccentric sliding wheels with cover  
 2 wall fixings  
 4 end stops  
 2 fixings for fixed panes  
 2 floor guides  
 1 corner junction for tracks  
 1 corner junction for profiles  
 Finish: /8 /15

Art.	For glass	Qty
<b>DCCFT90</b>	8 mm	1 Pc



**TRACK**

Material: AISI 304 steel

Finish: /8 /15

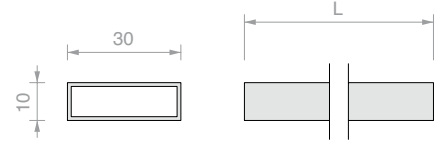

Art.	Length	Qty
<b>GLMFT1000</b>	1000 mm	1 Pc
<b>GLMFT2000</b>	2000 mm	1 Pc
<b>GLMFT3000</b>	3000 mm	1 Pc
<b>GLMDCCFORO</b>	Track cutting and drilling of 1 hole	1 Pc



**1 ECCENTRIC SLIDING WHEEL WITH COVER**

Material: AISI 304 steel

Finish: /8 /15

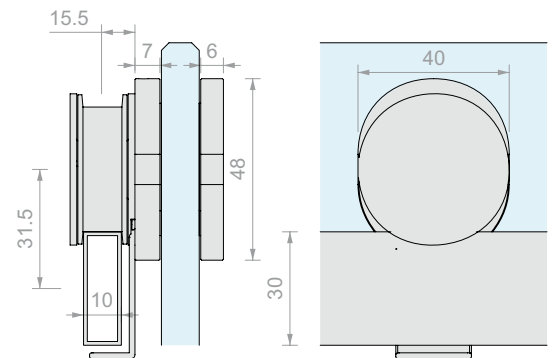

Art.	For glass	Qty
<b>DCCFT12</b>	From 8 to 10 mm	1 Pc



**FIXING FOR FIXED GLASS**

Material: AISI 304 steel

Recommended glass hole size Ø15 mm

Finish: /8 /15

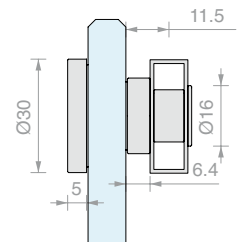

Art.	For glass	Qty
<b>DCCFT16</b>	From 8 to 10 mm	1 Pc



**WALL FIXING**

Material: AISI 304 steel

Finish: /8 /15

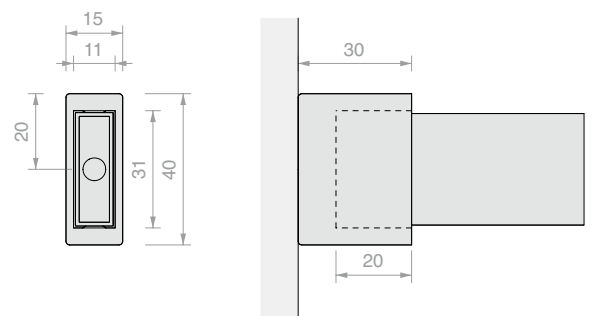

Art.	Qty
<b>DCCFT18</b>	1 Pc



**END STOP WITH RUBBER BUMPER**

Material: AISI 304 steel

Finish: /8 /15

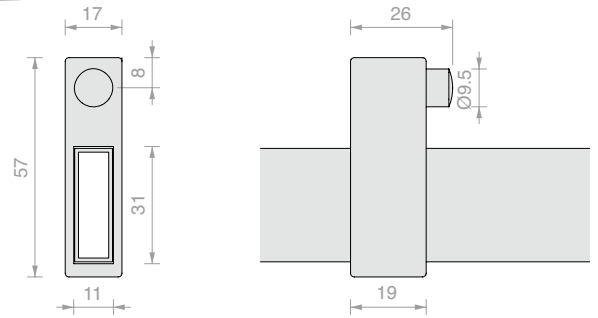

Art.

**DCCFT20**

Qty

1 Pc



**GLASS FIXING**

Material: AISI 304 steel

Finish: /8 /15

Recommended glass hole size Ø8 mm

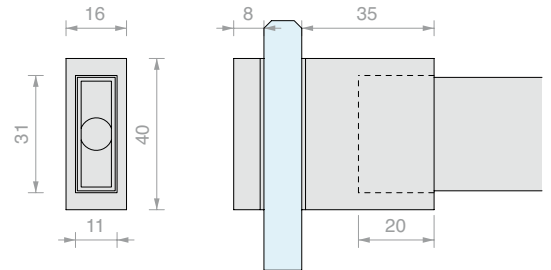

Art.

**GLMFT37**

For glass

From 8 to 10 mm

Qty

1 Pc



**CORNER JUNCTION**

Material: AISI 304 steel

Finish: /8 /15

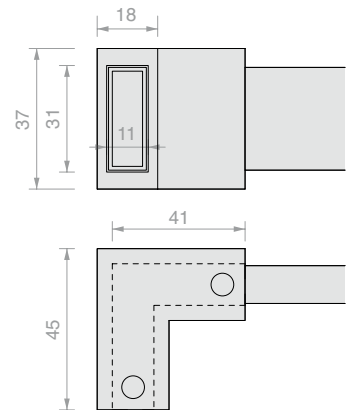

Art.

**GLMFT90**

Qty

1 Pc



**SNAP-ON FLOOR GUIDE FOR GLASS WITH PROFILE**

Material: Zamak

Compatible with aluminium profiles in the PBD and LMU series

Finish: /1 /24

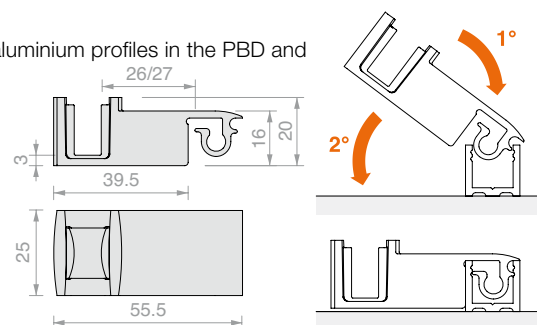

Art.

**DCC08**

**DCC10**

For glass

8 mm

10 mm

Qty

1 Pc

1 Pc



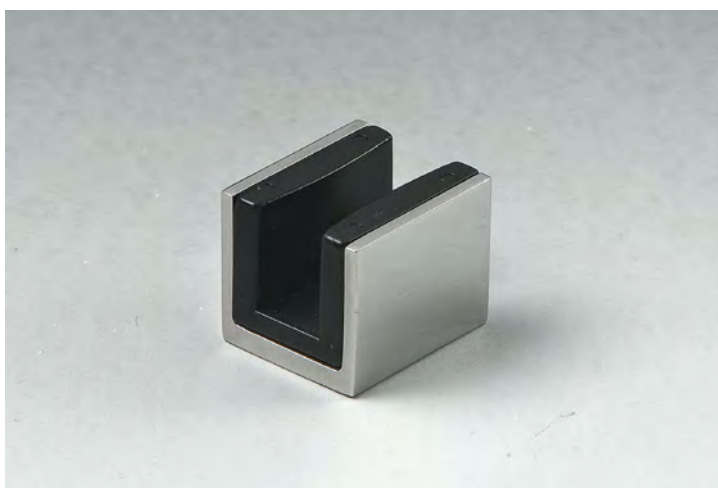

**FLOOR GUIDE**

Material: AISI 304 steel

Finish: /8 /15

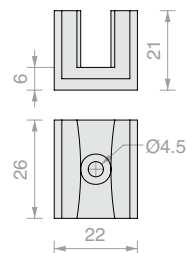

Art.	For glass	Qty
<b>GLMSPA06</b>	6 mm	1 Pc
<b>GLMSPA08</b>	8 mm	1 Pc
<b>GLMSPA10</b>	10 mm	1 Pc



**U-SHAPED PROFILE**

Material: Aluminium

Finish: /6 /88 /91 /97

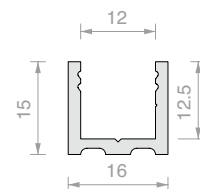

Art.	Length	Qty
<b>PBD3183.150</b>	1498 mm	1 Pc
<b>PBD3183.220</b>	2200 mm	1 Pc
<b>PBD3183</b>	3000 mm	1 Pc



**ROUNDED UPPER PROFILE PBD3184**

Material: Aluminium

Finish: /6 /88 /91 /97

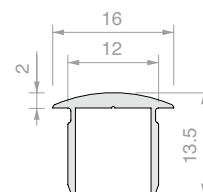

Art.	Length	Qty
<b>PBD3184.100</b>	992 mm	1 Pc
<b>PBD3184.150</b>	1498 mm	1 Pc
<b>PBD3184</b>	3000 mm	1 Pc



**ROUNDED CAP PBD**

Material: Aluminium

Finish: /6 /88 /91 /97

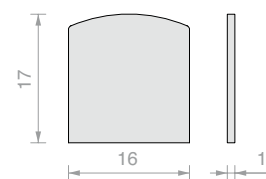

Art.	Qty
<b>PBDTP</b>	1 Pc



**FLAT UPPER PROFILE PBD3186**

Material: Aluminium

Finish: /6 /88 /91 /97

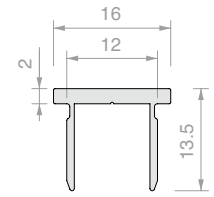

Art.	Length	Qty
<b>PBD3186.100</b>	992 mm	1 Pc
<b>PBD3186.150</b>	1498 mm	1 Pc
<b>PBD3186</b>	3000 mm	1 Pc



**PBD FLAT CAP**

Material: Aluminium

Finish: /6 /88 /91 /97

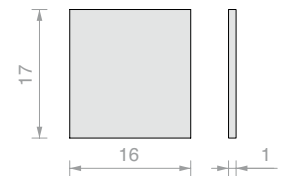

Art.	Qty
<b>PBD86TP</b>	1 Pc



**CORNER JOINT FOR PROFILE**

Material: Zamak

Compatible with aluminium profiles in the PBD and LMU series  
For PBD3184 upper profile

Finish: /1 /6 /24 /97

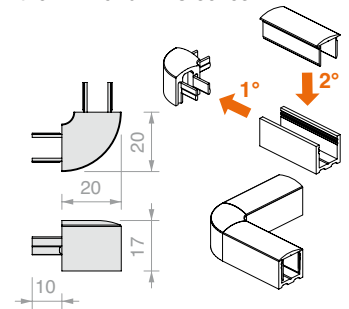

Art.	Qty
<b>DCC90</b>	1 Pc



**FLAT CORNER JOINT FOR PROFILE**

Material: Zamak

Compatible with aluminium profiles in the PBD and LMU series  
For PBD3186 upper profile

Finish: /1 /6 /24 /97

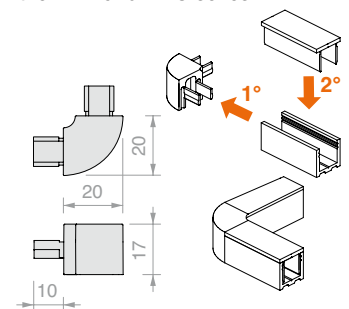

Art.	Qty
<b>DCC90SQ</b>	1 Pc



**GLASS HOLDER GASKET**

Material: PVC

Art.	Thickness	Colour	Qty	Art.	Thickness	Colour	Qty
<b>GTUP2</b>	2	Transparent	1 m	<b>GTUP5G</b>	5	Embossed	1 m
<b>GTUP3</b>	3	Transparent	1 m	<b>GTUP6G</b>	6	Embossed	1 m
<b>GTUP4</b>	4	Transparent	1 m	<b>GTUP2N</b>	2	Black	1 m
<b>GTUP5</b>	5	Transparent	1 m	<b>GTUP3N</b>	3	Black	1 m
<b>GTUP6</b>	6	Transparent	1 m	<b>GTUP4N</b>	4	Black	1 m
<b>GTUP2G</b>	2	Embossed	1 m	<b>GTUP5N</b>	5	Black	1 m
<b>GTUP3G</b>	3	Embossed	1 m	<b>GTUP6N</b>	6	Black	1 m
<b>GTUP4G</b>	4	Embossed	1 m				



**MAGNETIC 45° GASKET**

Material: Co-extruded rigid and soft PVC

Resistant to UV rays

Fungicide to prevent mould from forming

Maximum operating temperature 70°C

Colour: transparent balloon, white magnet

Art.	Length	For glass	Qty
<b>GM62SX</b>	2200 mm	From 6 to 8 mm	1 Pc
<b>GM6230SX</b>	3000 mm	From 6 to 8 mm	1 Pc
<b>GM62DX</b>	2200 mm	From 6 to 8 mm	1 Pc
<b>GM6230DX</b>	3000 mm	From 6 to 8 mm	1 Pc

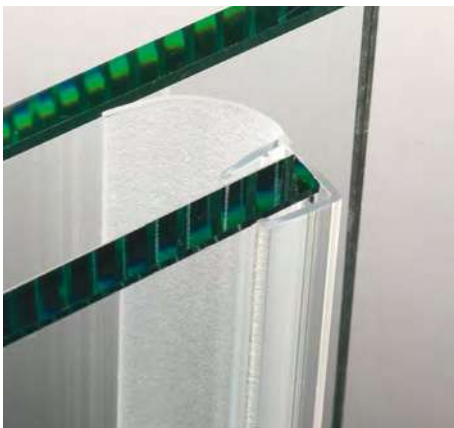
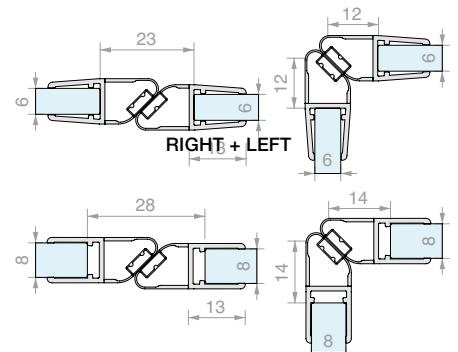

**GASKET WITH SIDE LIP**

Material: Co-extruded rigid and soft PVC - Resistant to UV rays

Fungicide to prevent mould from forming

Colour: transparent/\*black, embossed lip

Art.	Length	For glass	Qty
<b>GM014</b>	2000 mm	From 8 to 10 mm	1 Pc
<b>GM01422</b>	2200 mm	From 8 to 10 mm	1 Pc
<b>GM01422NR*</b>	2200 mm	From 8 to 10 mm	1 Pc
<b>GM01425</b>	2500 mm	From 8 to 10 mm	1 Pc
<b>GM01425NR*</b>	2500 mm	From 8 to 10 mm	1 Pc
<b>GM0143000</b>	3000 mm	From 8 to 10 mm	1 Pc
<b>GM0143000NR*</b>	3000 mm	From 8 to 10 mm	1 Pc

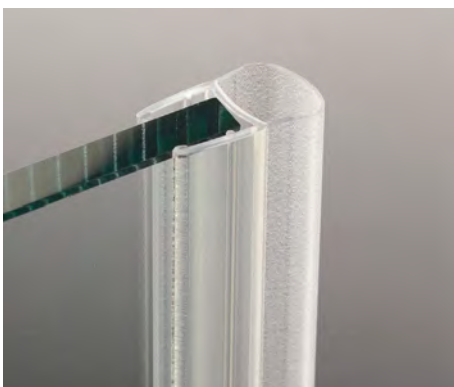
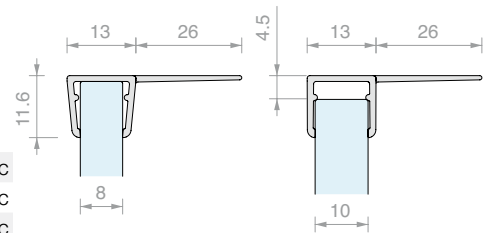

**BALLOON GASKET**

Material: Co-extruded rigid and soft PVC

Resistant to UV rays. Fungicide to prevent mould from forming

Colour: transparent/\*black, transparent balloon

Art.	Length	For glass	Qty
<b>GM06</b>	2000 mm	From 8 to 10 mm	1 Pc
<b>GM0622</b>	2200 mm	From 8 to 10 mm	1 Pc
<b>GM0622NR*</b>	2200 mm	From 8 to 10 mm	1 Pc
<b>GM0625</b>	2500 mm	From 8 to 10 mm	1 Pc
<b>GM0625NR*</b>	2500 mm	From 8 to 10 mm	1 Pc
<b>GM063000</b>	3000 mm	From 8 to 10 mm	1 Pc
<b>GM063000NR*</b>	3000 mm	From 8 to 10 mm	1 Pc

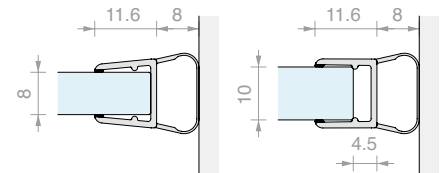

**HANDLE WITH VHB FIXING**

Material: AISI 304 steel

Finish: /8 /15

Art.	Qty
<b>HAND10057VHB</b>	1 Pc

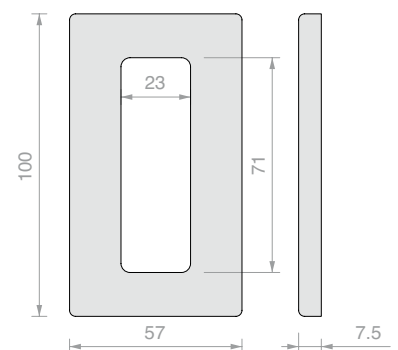

# GIUMAX

## *Design*

Rounded shapes combine with the strength of a fully stainless steel track for enviable performance. GIUMAX SHOWER joins the style of its carriers with the resistance of AISI 304 stainless steel.





/8  
Brushed steel

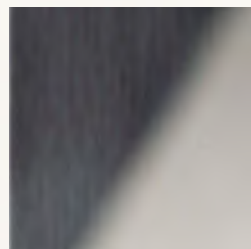

/15  
Polished steel



# GIUMAX

## Technical properties

The sliding shower door system for 8-mm glass in the GIUMAX series uses visible sliding wheels on load-bearing tracks. These solutions are made of AISI 304 stainless steel and stand out for their elegance, reliability and durability.

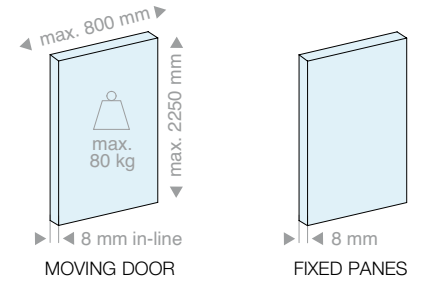

### 3 configurations

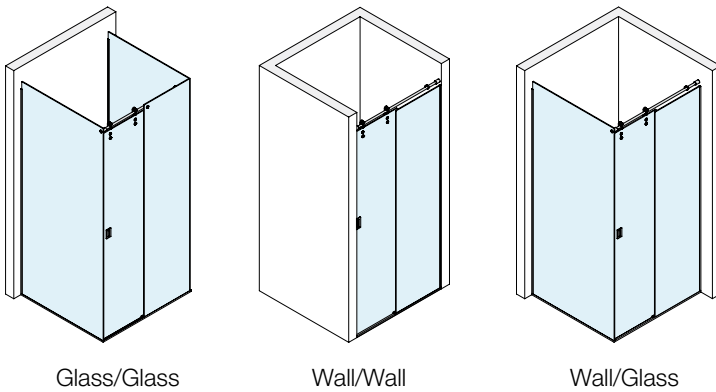

### Types of installation

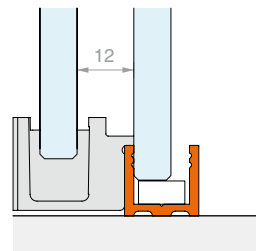
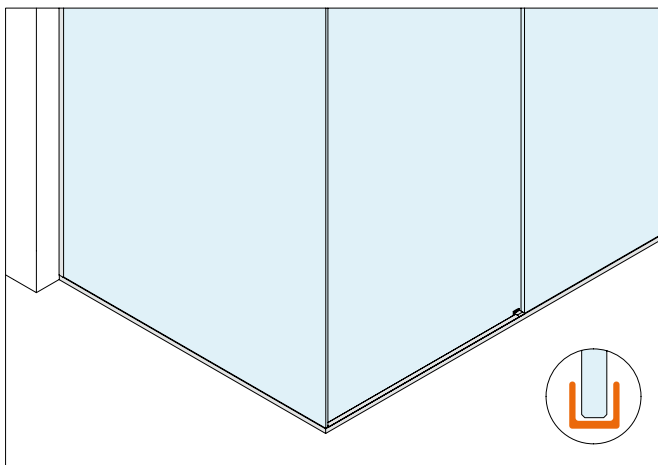

### Kits

#### For framed fixed panes

Simple, modern design.  
With Linea U, fixed panes are held within a 15 mm x 16 mm aluminium profile.  
The same profile, with an upper snap-on cover, acts as a water barrier in the open area.

### Installation with pair of sliding wheels

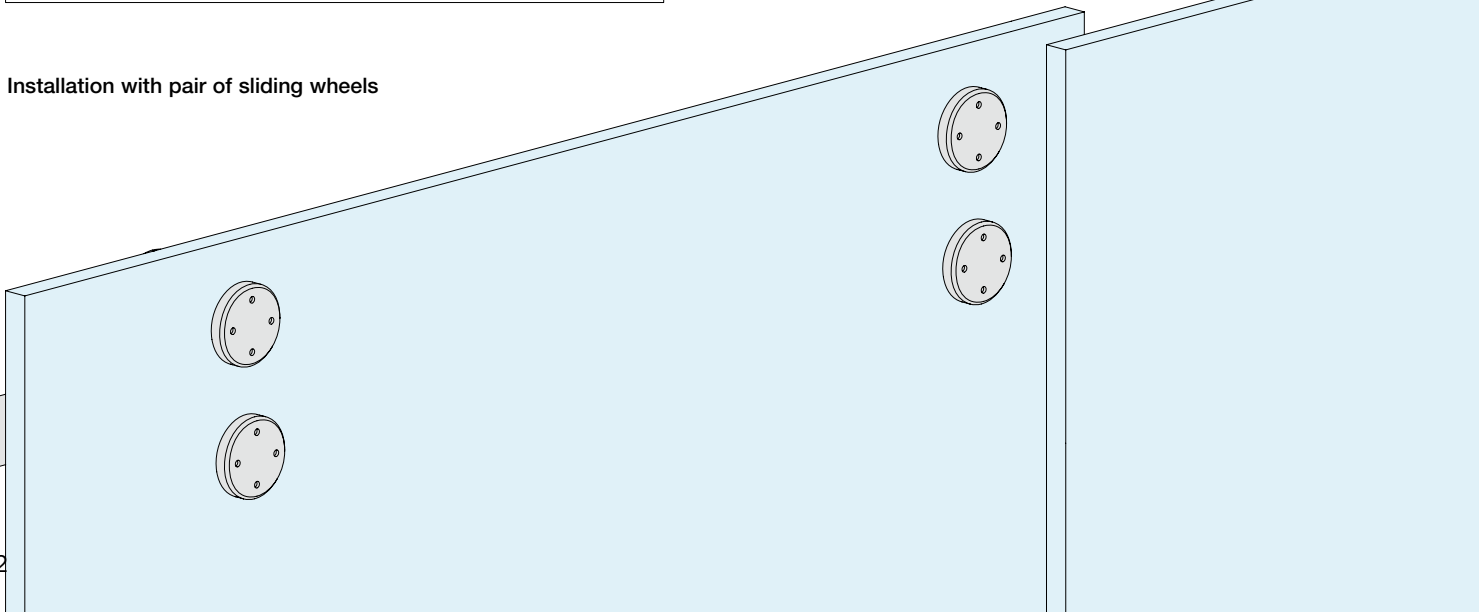

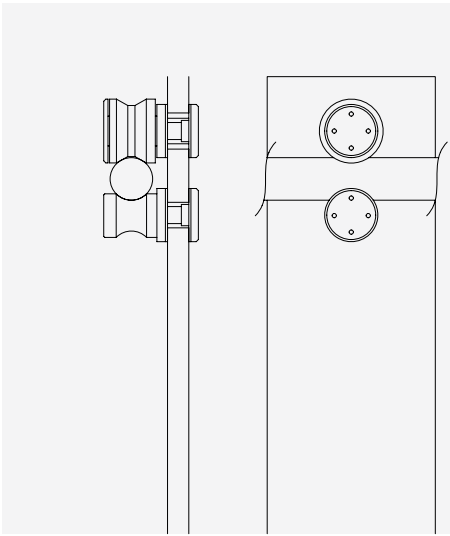

**SYSTEM WITH SLIDING WHEELS**

The door is mounted on two sliding wheels and the track operates within the dimensions of the door.

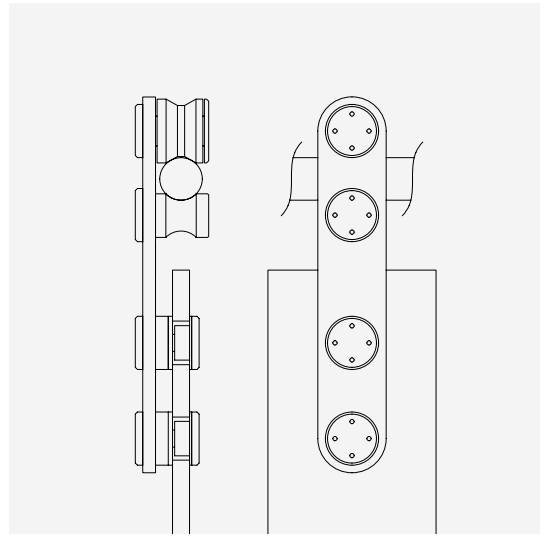

**SYSTEM WITH CARRIER**

The door is mounted on carrier. The track moves in the upper part of the carrier, above the door.

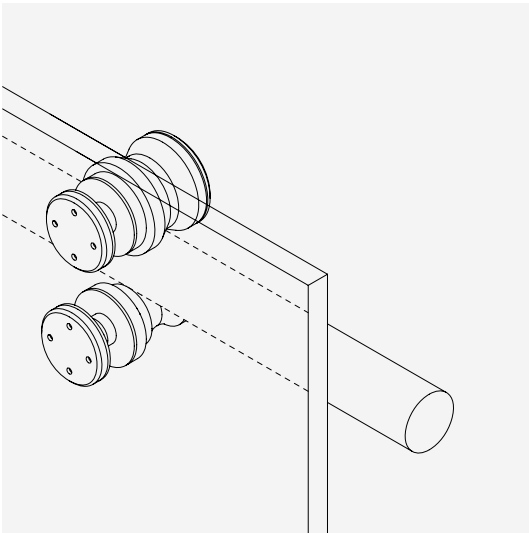

**MAXIMUM TRANSPARENCY**

The system stands out for its goal of obtaining the utmost transparency with the use of sleek accessories and a minimal design.

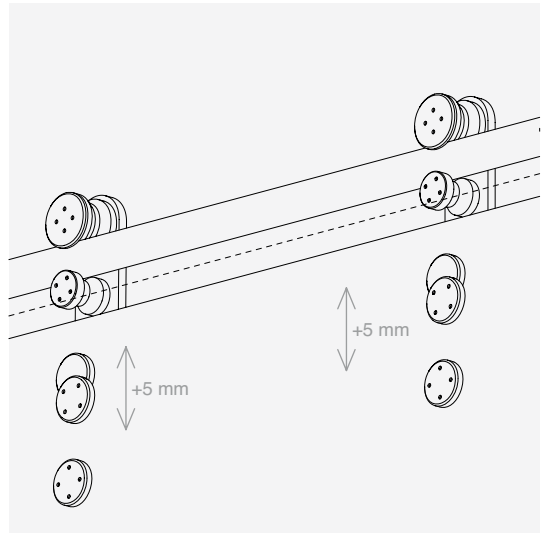

**DOOR ADJUSTMENT**

With the carrier technology, the height of the sliding wheel and hubs can be adjusted, thereby regulating the position of the door.

Installation with carrier

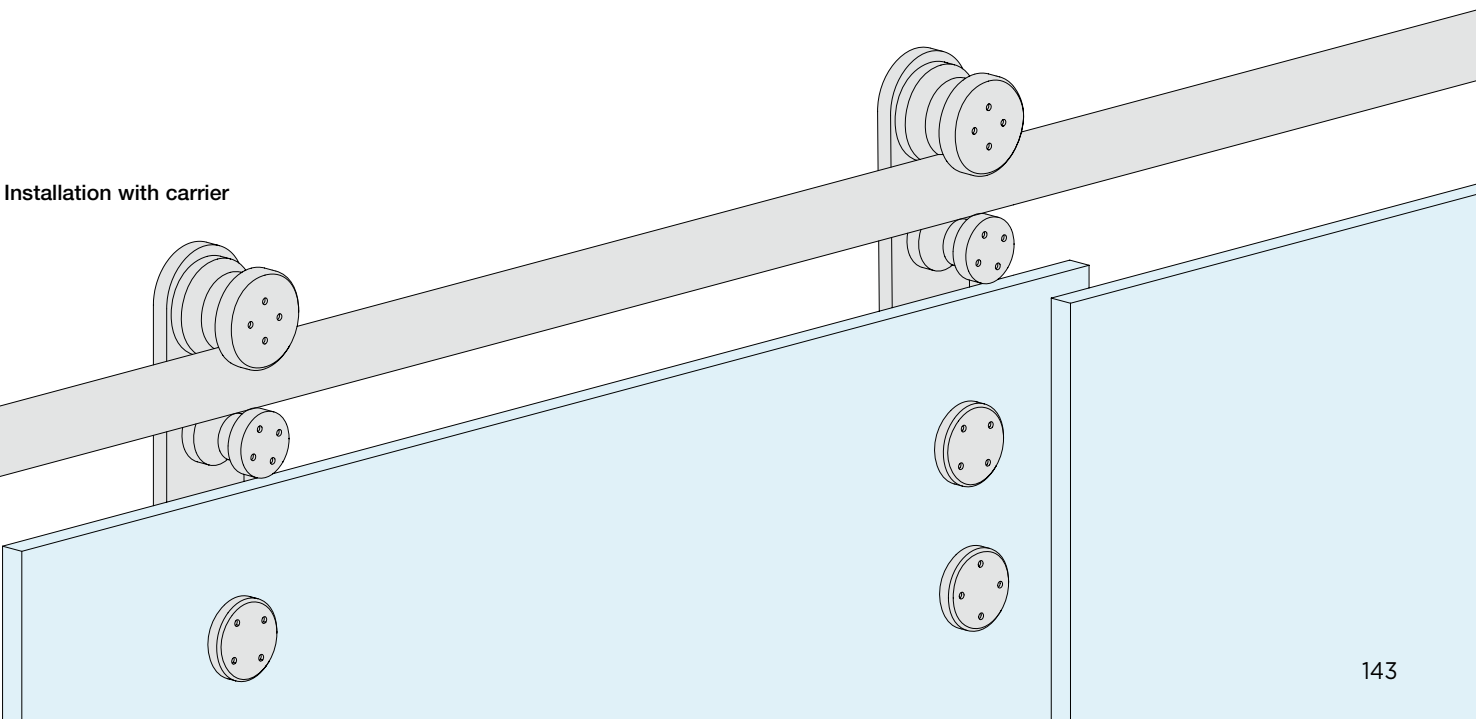





# GIUMAX

*Kit*



## CONFIGURATIONS WITH FRAMED FIXED PANES

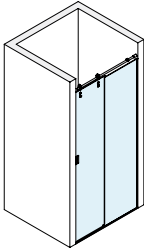

Page 146

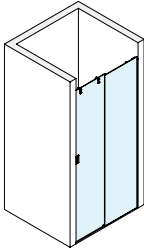

Page 147

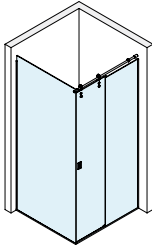

Page 148

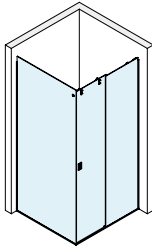

Page 149

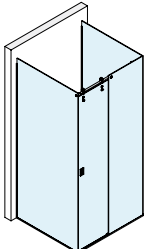

Page 150

**WALL/WALL SLIDING DOOR SHOWER KIT WITH FRAME PROFILE FOR FIXED PANE AND CARRIERS**

Finish: /8 /15

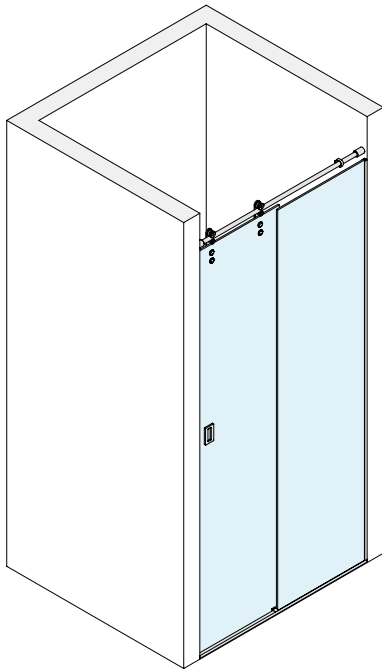

Kit comprising:

Art.	Description	Qty
<b>GLM3000</b>	Kit of 2 carriers on a plate	1 Pc
<b>GLMDSTP</b>	Wall fixing	2 Pcs
<b>GLM3023</b>	End stop	2 Pcs
<b>DCC218</b>	Floor guide	1 Pc
<b>GLMTND10</b>	Track	1 Pc
<b>PBD3183.220</b>	U-shaped profile	1 Pc
<b>PBD3183.150</b>	U-shaped profile	1 Pc
<b>PBD3184.150</b>	Rounded upper profile	1 Pc
<b>GTUP4</b>	Glass holder gasket	4 m
<b>GM0141022</b>	Gasket with side lip	1 Pc
<b>GM0622</b>	Balloon gasket	1 Pc
<b>HAND10057VHB</b>	Adhesive handle	2 Pcs

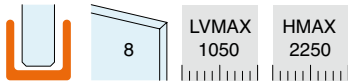
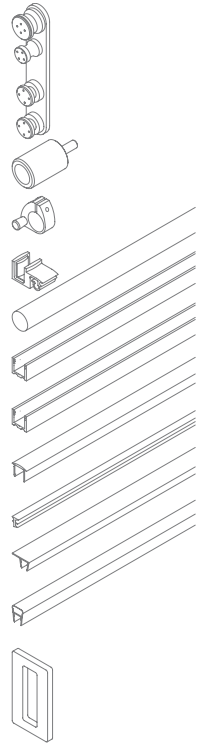

RECOMMENDED LAYOUTS

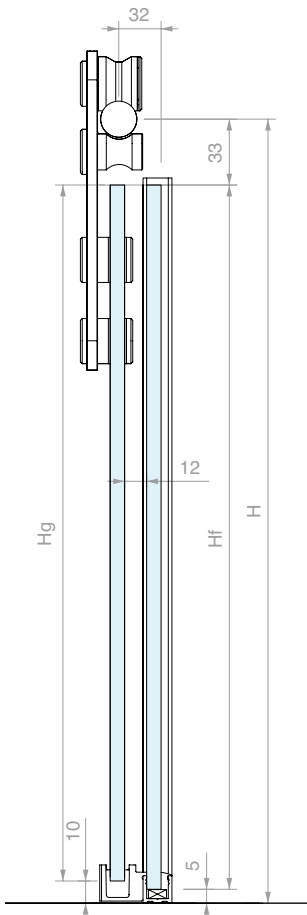

GLASS PANE DIMENSIONS

$L_g = (LV + 20) / 2$   
 $L_f = L_g$

$H_g = H - 43$   
 $H_f = H - 38$

$LA = (LV - 112) / 2$

PRIMARY LENGTHS (mm)

LV	Lg	Lf	LA
1000	510	510	444
950	485	485	419

TRACK PROCESSING

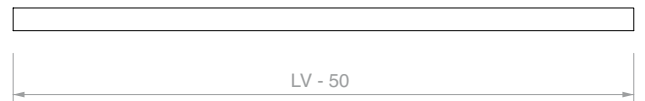

CLOSED SLIDING DOOR CONFIGURATION

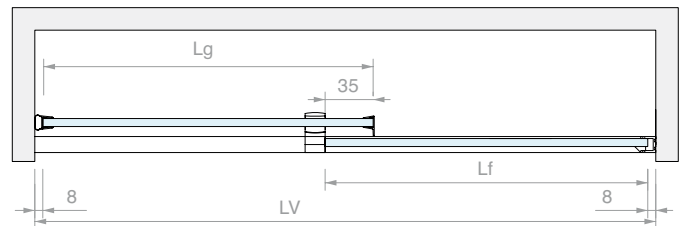

OPEN SLIDING DOOR CONFIGURATION

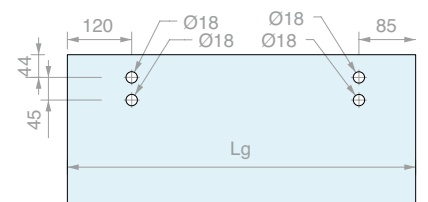
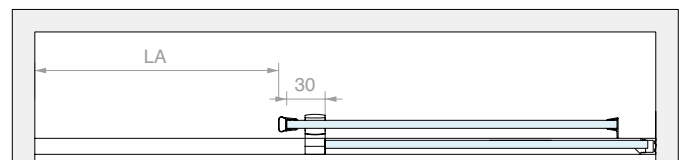

Art.  
**GLMKIT301**

Qty  
1 Pc

**WALL/WALL SLIDING DOOR SHOWER KIT WITH FRAME PROFILE FOR FIXED PANE AND SLIDING WHEELS**

Finish: /8 /15

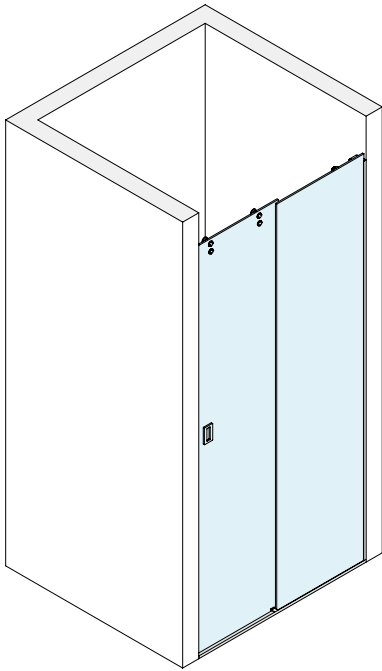

Kit comprising:

Art.	Description	Qty
<b>GLM7000</b>	Kit of 2+2 sliding wheels	1 Pc
<b>GLMDSTP</b>	Wall fixing	2 Pcs
<b>GLM3020</b>	End stop	2 Pcs
<b>DCC218</b>	Floor guide	1 Pc
<b>GLMTND10</b>	Track	1 Pc
<b>PBD3183.220</b>	U-shaped profile	1 Pc
<b>PBD3183.150</b>	U-shaped profile	1 Pc
<b>PBD3184.150</b>	Rounded upper profile	1 Pc
<b>GTUP4</b>	Glass holder gasket	4 m
<b>GM0141022</b>	Gasket with side lip	1 Pc
<b>GM0622</b>	Balloon gasket	1 Pc
<b>HAND10057VHB</b>	Adhesive handle	2 Pcs

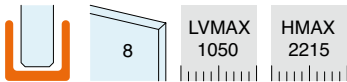
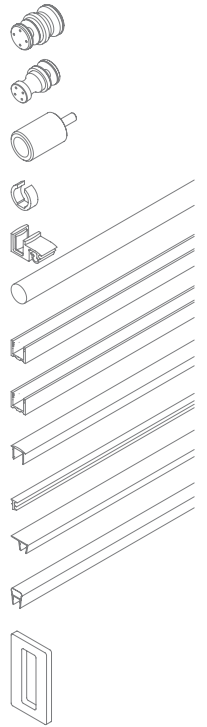

RECOMMENDED LAYOUTS

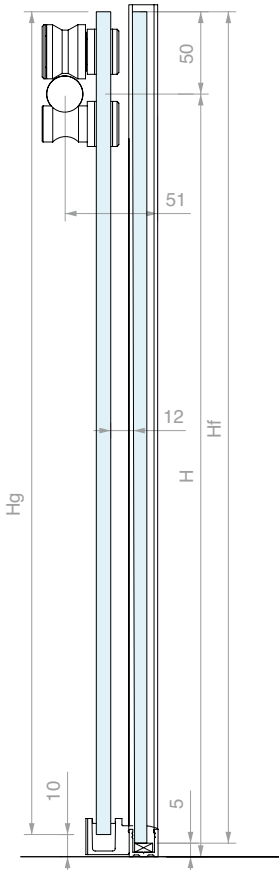

GLASS PANE DIMENSIONS

$L_g = (LV + 20) / 2$   
 $L_f = L_g$

$H_g = H + 40$   
 $H_f = H + 45$

$LA = (LV - 112) / 2$

PRIMARY LENGTHS (mm)

LV	Lg	Lf	LA
1000	510	510	444
950	485	485	419

TRACK PROCESSING

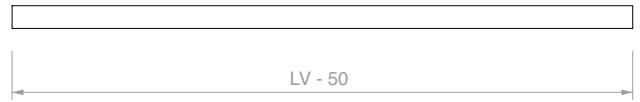

CLOSED SLIDING DOOR CONFIGURATION

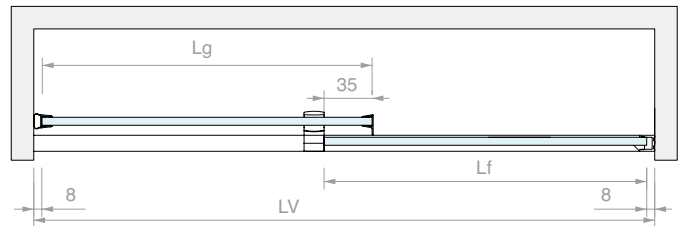

OPEN SLIDING DOOR CONFIGURATION

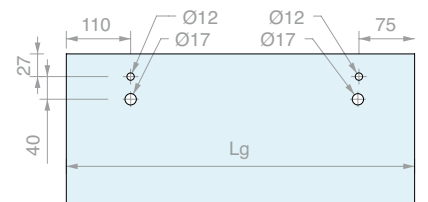
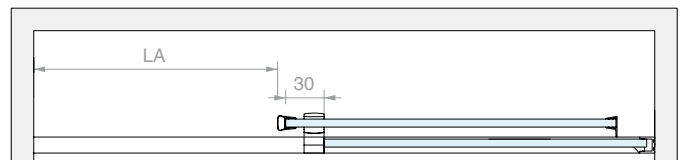

Art.  
**GLMKIT701**

Qty  
1 Pc

**WALL/GLASS SLIDING DOOR SHOWER KIT WITH FRAME PROFILE FOR FIXED PANES AND CARRIERS**

Finish: /8 /15

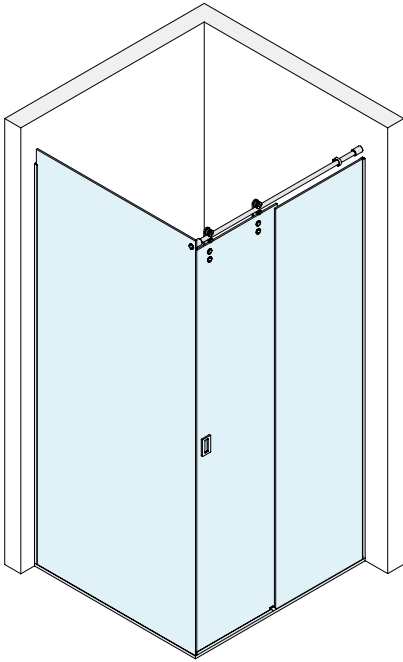

Kit comprising:

Art.	Description	Qty
<b>GLM3000</b>	Kit of 2 carriers on a plate	1 Pc
<b>GLMDSTP</b>	Wall fixing	1 Pc
<b>GLMDSTV</b>	Glass fixing	1 Pc
<b>GLM3023</b>	End stop	2 Pcs
<b>DCC218</b>	Floor guide	1 Pc
<b>GLMTND10</b>	Track	1 Pc
<b>PBD3183.220</b>	U-shaped profile	2 Pcs
<b>PBD3183.150</b>	U-shaped profile	2 Pcs
<b>PBD3184.150</b>	Rounded upper profile	1 Pc
<b>GTUP4</b>	Glass holder gasket	7 m
<b>GM0141022</b>	Gasket with side lip	1 Pc
<b>GM0622</b>	Balloon gasket	1 Pc
<b>HAND10057VHB</b>	Adhesive handle	2 Pcs

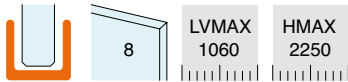
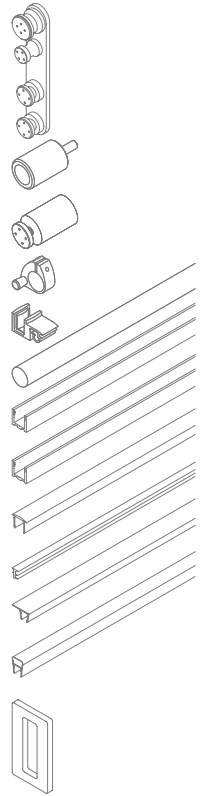

RECOMMENDED LAYOUTS

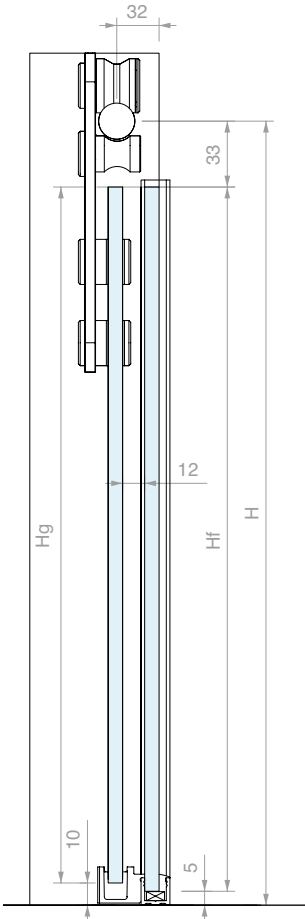

GLASS PANE DIMENSIONS

$L_g = (LV + 5) / 2$   
 $L_f = L_g$

$H_g = H - 43$   
 $H_f = H - 38$

$L_l = P - 14$   
 $H_l = H + 35$

$LA = (LV - 126) / 2$

PRIMARY LENGTHS (mm)

LV	Lg	Lf	LA
1000	503	503	437
950	478	478	412

TRACK PROCESSING



CLOSED SLIDING DOOR CONFIGURATION

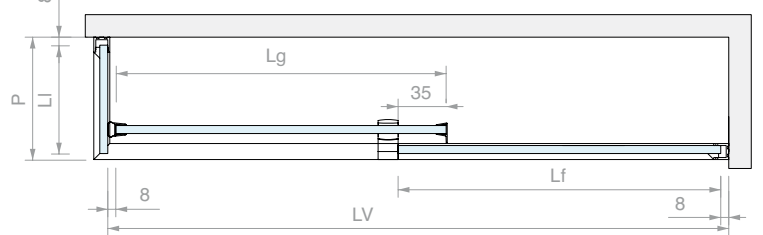

OPEN SLIDING DOOR CONFIGURATION

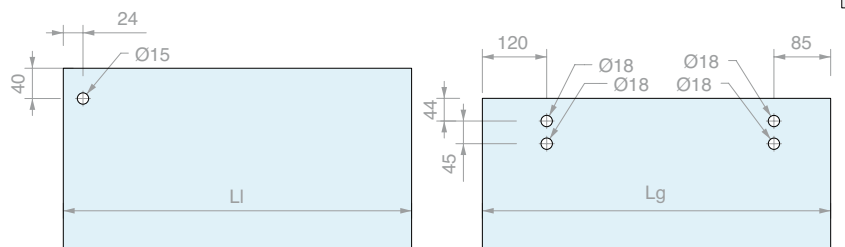
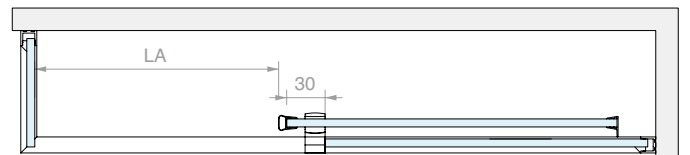

Art.  
**GLMKIT303**

Qty  
1 Pc

**WALL/GLASS SLIDING DOOR SHOWER KIT WITH FRAME PROFILE FOR FIXED PANES AND SLIDING WHEELS**

Finish: /8 /15

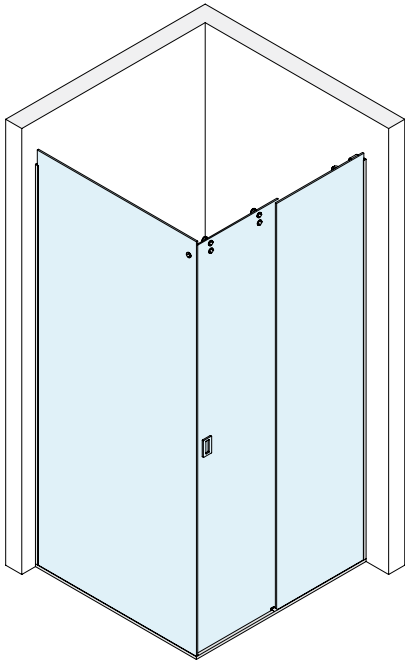

Kit comprising:

Art.	Description	Qty
<b>GLM7000</b>	Kit of 2+2 sliding wheels	1 Pc
<b>GLMDSTP</b>	Wall fixing	1 Pc
<b>GLMDSTV</b>	Glass fixing	1 Pc
<b>GLM3020</b>	End stop	2 Pcs
<b>DCC218</b>	Floor guide	1 Pc
<b>GLMTND10</b>	Track	1 Pc
<b>PBD3183.220</b>	U-shaped profile	2 Pcs
<b>PBD3183.150</b>	U-shaped profile	2 Pcs
<b>PBD3184.150</b>	Rounded upper profile	1 Pc
<b>GTUP4</b>	Glass holder gasket	7 m
<b>GM0141022</b>	Gasket with side lip	1 Pc
<b>GM0622</b>	Balloon gasket	1 Pc
<b>HAND10057VHB</b>	Adhesive handle	2 Pcs

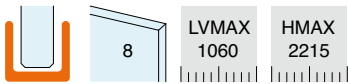
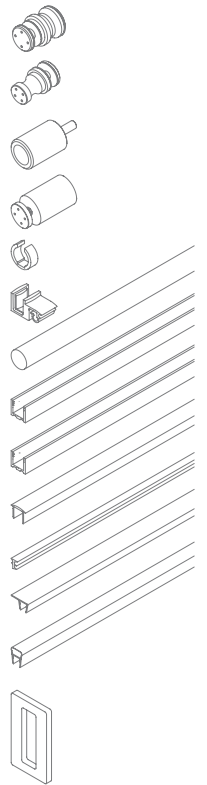

RECOMMENDED LAYOUTS

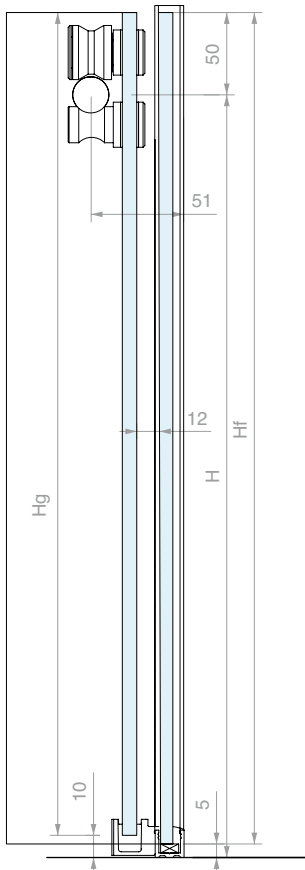

GLASS PANE DIMENSIONS

$L_g = (LV + 5) / 2$   
 $L_f = L_g$

$H_g = H + 40$   
 $H_f = H + 45$

$L_i = P - 14$   
 $H_i = H + 45$

$LA = (LV - 126) / 2$

PRIMARY LENGTHS (mm)

LV	Lg	Lf	LA
1000	503	503	437
950	478	478	412

TRACK PROCESSING

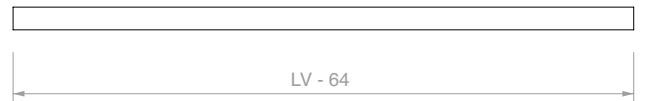

CLOSED SLIDING DOOR CONFIGURATION

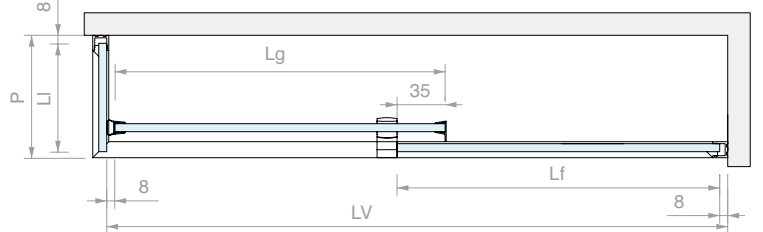

OPEN SLIDING DOOR CONFIGURATION

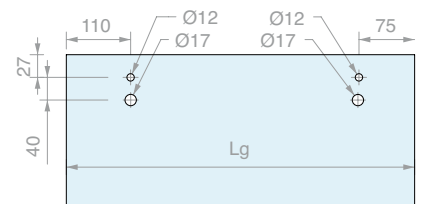
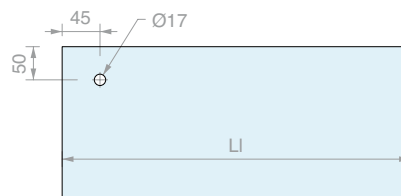
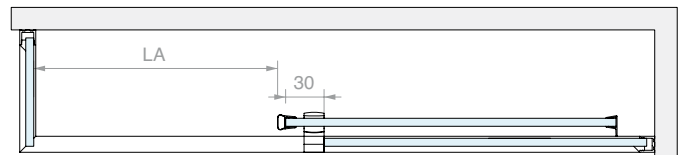

Art. **GLMKIT703**

Qty  
1 Pc

**GLASS/GLASS SLIDING DOOR SHOWER KIT WITH FRAME PROFILE FOR FIXED PANES AND CARRIERS**

Finish: /8 /15

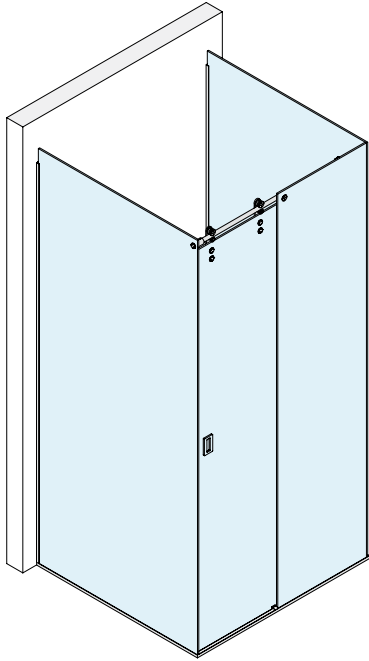

Kit comprising:

Art.	Description	Qty
<b>GLM3000</b>	Kit of 2 carriers on a plate	1 Pc
<b>GLMBRV</b>	Fixing for fixed glass	1 Pc
<b>GLMDSTV</b>	Glass fixing	2 Pcs
<b>GLM3023</b>	End stop	2 Pcs
<b>DCC218</b>	Floor guide	1 Pc
<b>GLMBDLN15</b>	Track	1.5 m
<b>GLMFORO</b>	Customised hole drilling	1 Pc
<b>PBD3183.220</b>	U-shaped profile	2 Pcs
<b>PBD3183.150</b>	U-shaped profile	3 Pcs
<b>PBD3184.150</b>	Rounded upper profile	1 Pc
<b>GTUP4</b>	Glass holder gasket	7 m
<b>GM0141022</b>	Gasket with side lip	1 Pc
<b>GM0622</b>	Balloon gasket	1 Pc
<b>HAND10057VHB</b>	Adhesive handle	2 Pcs

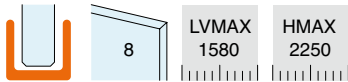
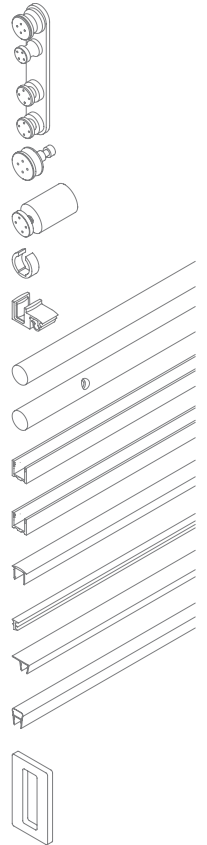

RECOMMENDED LAYOUTS

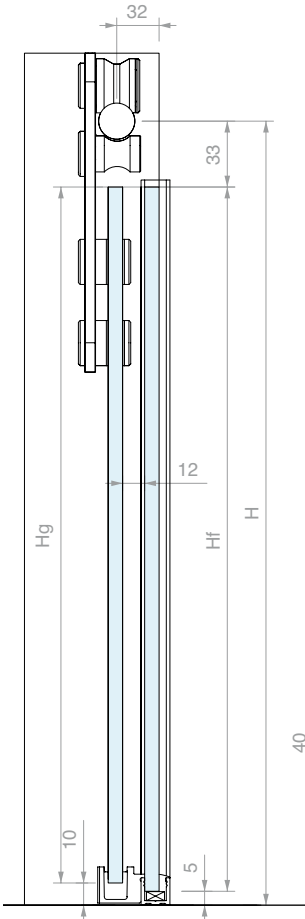

GLASS PANE DIMENSIONS

$L_g = LV / 2$   
 $L_f = L_g$

$H_g = H - 43$   
 $H_f = H + 35$

$L_i = P - 14$   
 $H_i = H + 35$

$LA = (LV - 140) / 2$

PRIMARY LENGTHS (mm)

LV	Lg	Lf	LA
1500	750	750	680
1400	700	700	630

TRACK PROCESSING



CLOSED SLIDING DOOR CONFIGURATION

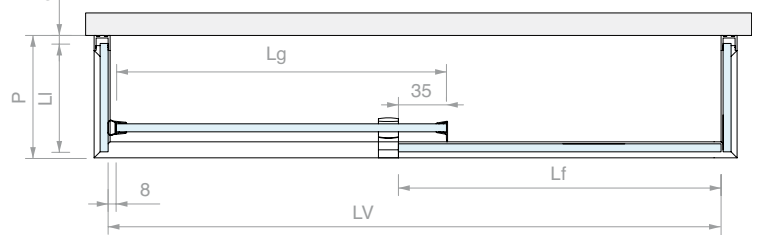

OPEN SLIDING DOOR CONFIGURATION

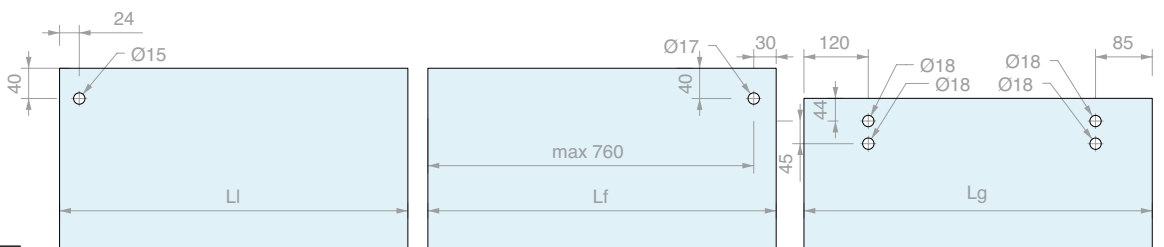
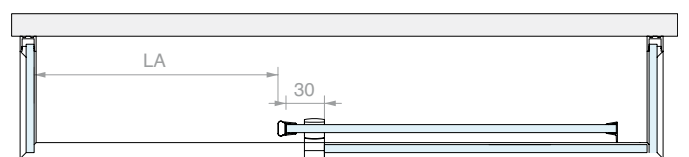

Art. **GLMKIT305**

Qty **1 Pc**

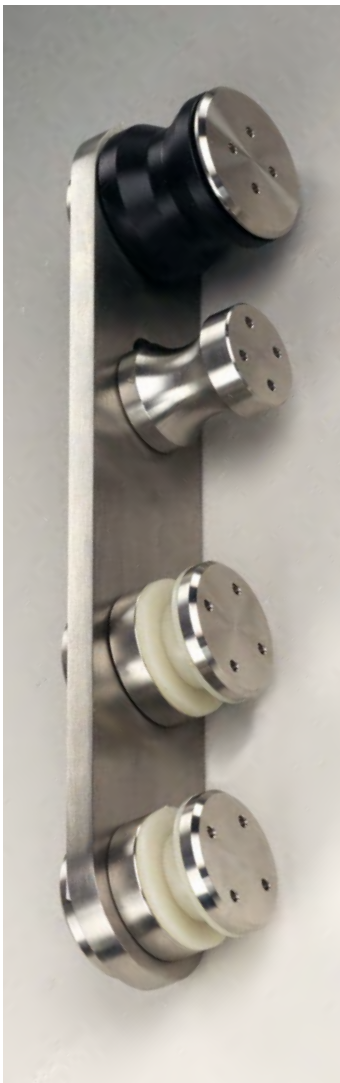

**CARRIER**

Material: AISI 304 stainless steel  
 Recommended holes size Ø18 mm  
 Recommended tool for tightening Art. UT200  
 Finish: /9 /15

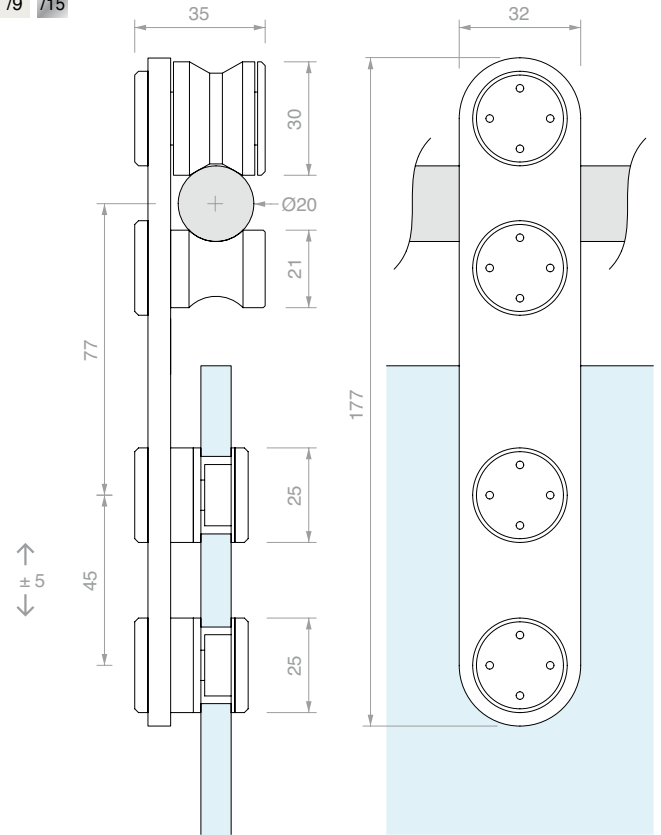

Art.	Description	For glass	Qty
<b>GLM3050</b>	Single carrier	From 8 to 10.7 mm	1 Pc
<b>GLM3000</b>	Kit of 2 carriers	From 8 to 10.7 mm	1 Pc



**WHEELS**

Material: AISI 304 stainless steel  
 Recommended holes size GLMRCT Ø12 mm  
 Recommended holes size GLMAN Ø17 mm  
 Recommended tool for tightening Art. UT200  
 Finish: /9 /15

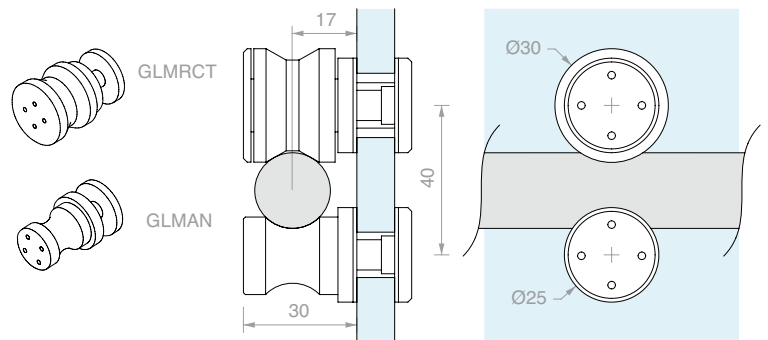

Art.	Description	For glass	Qty
<b>GLMRCT</b>	Sliding wheel	From 6 to 12.7 mm	1 Pc
<b>GLMAN</b>	Anti-derailment pin	From 6 to 12.7 mm	1 Pc
<b>GLM7000</b>	Kit of 2 wheels + 2 pins	From 6 to 12.7 mm	1 Pc



**DRILLED SOLID ROUND TRACK**

Material: AISI 304 stainless steel

Finish: /8 /15

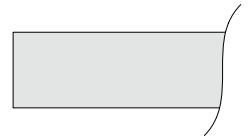
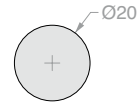

Track drilling pattern:

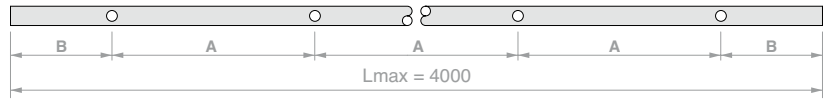

Art.	Length	No. holes	Dimensions	Qty
<b>GLMTND10</b>	1000 mm	-	- - -	1 Pc
<b>GLMBDLN15</b>	cut to size	-	- - -	1 m
<b>GLMFORO</b>	Hole for GLMBDLN15	1	cut to size cut to size	1 Pc



**WALL FIXING**

Material: AISI 304 stainless steel

Finish: /9 /15

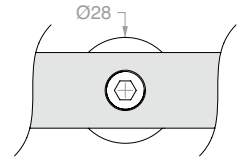
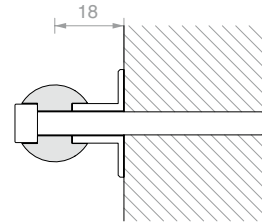

Art.	Description	Qty
<b>GLMBRM</b>	With M6 mm x 60 mm screws	1 Pc



**GLASS FIXING**

Material: AISI 304 stainless steel

Recommended hole size Ø18 mm

Recommended tool for tightening Art. UT200

Finish: /9 /15

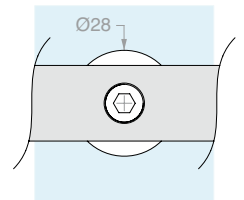
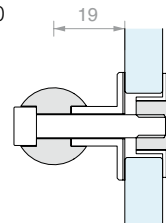

Art.	Description	For glass	Qty
<b>GLMBRV</b>	With M6 mm x 30 mm screws	From 8 to 10 mm	1 Pc



**SIDE WALL FIXING**

Material: AISI 304 stainless steel

Finish: /9 /15

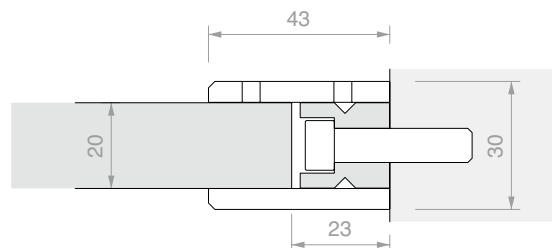

Art.	Qty
<b>GLMDSTP</b>	1 Pc





**SIDE GLASS FIXING**

Material: AISI 304 stainless steel  
 Recommended hole size Ø15 mm  
 Recommended tool for tightening Art. UT200  
 Finish: /9 /15

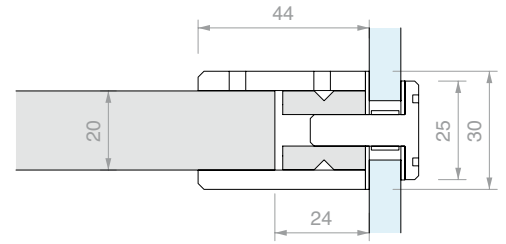

Art.	For glass	Qty
<b>GLMDSTV</b>	From 8 to 15 mm	1 Pc



**END STOP**

Material: AISI 304 stainless steel  
 Finish: /9 /15

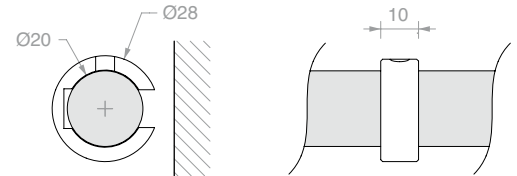

Art.	Qty
<b>GLM3020</b>	1 Pc



**OVAL END STOP WITH RUBBER BUMPER**

Material: AISI 304 stainless steel  
 Finish: /9 /15

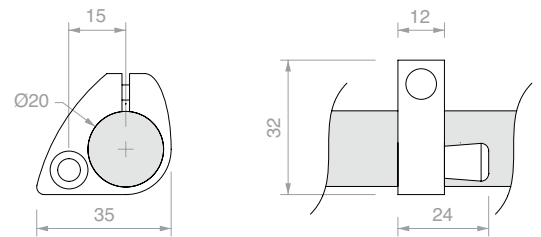

Art.	Qty
<b>GLM3023</b>	1 Pc



**SNAP-ON FLOOR GUIDE FOR GLASS WITH PROFILE**

Material: Zamak  
 Compatible with aluminium profiles in the PBD and LMU series  
 Finish: /1 /24

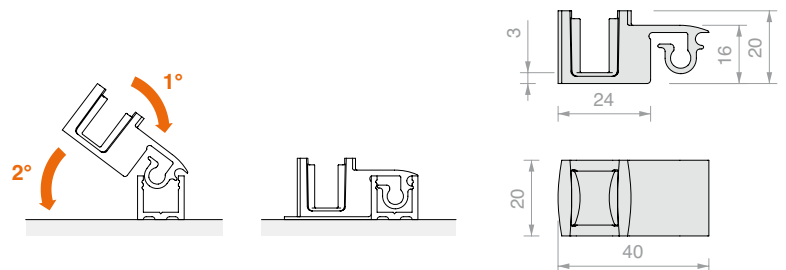

Art.	For glass	Qty
<b>DCC218</b>	8 mm	1 Pc
<b>DCC220</b>	10 mm	1 Pc



**U-SHAPED PROFILE PBD3183**

Material: Aluminium  
 Finish: /6 /88 /91 /97

Art.	Length	Qty
<b>PBD3183.150</b>	1498 mm	1 Pc
<b>PBD3183.220</b>	2200 mm	1 Pc
<b>PBD3183</b>	3000 mm	1 Pc

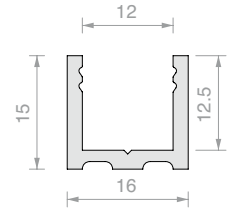

**ROUNDED UPPER PROFILE PBD3184**

Material: Aluminium  
 Finish: /6 /88 /91 /97

Art.	Length	Qty
<b>PBD3184.100</b>	992 mm	1 Pc
<b>PBD3184.150</b>	1498 mm	1 Pc
<b>PBD3184</b>	3000 mm	1 Pc

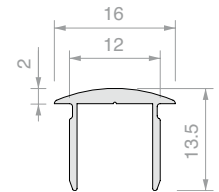

**ROUNDED CAP PBD**

Material: Aluminium  
 Finish: /6 /88 /91 /97

Art.	Qty
<b>PBDTP</b>	1 Pc

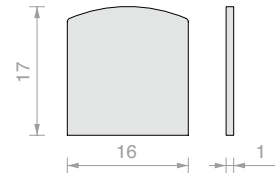

**FLAT UPPER PROFILE PBD3186**

Material: Aluminium  
 Finish: /6 /88 /91 /97

Art.	Length	Qty
<b>PBD3186.100</b>	992 mm	1 Pc
<b>PBD3186.150</b>	1498 mm	1 Pc
<b>PBD3186</b>	3000 mm	1 Pc

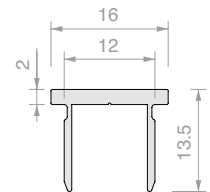

**PBD FLAT CAP**

Material: Aluminium  
 Finish: /6 /88 /91 /97

Art.	Qty
<b>PBD86TP</b>	1 Pc

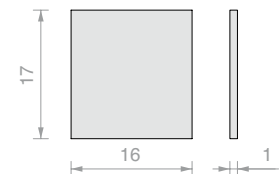

**CORNER JOINT FOR PROFILE**

Material: Zamak  
 Compatible with aluminium profiles in the PBD and LMU series  
 For PBD3184 upper profile  
 Finish: /1 /6 /24 /97

Art.	Qty
<b>DCC90</b>	1 Pc

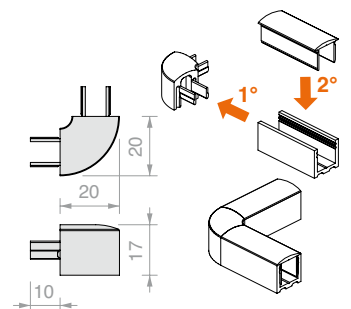



**FLAT CORNER JOINT FOR PROFILE**

Material: Zamak

Compatible with aluminium profiles in the PBD and LMU series

For PBD3186 upper profile

Finish: /1 /6 /24 /97

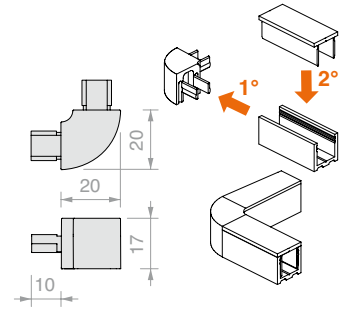

Art.	Qty
<b>DCC90SQ</b>	1 Pc



**GLASS HOLDER GASKET**

Material: PVC

Art.	Thickness	Colour	Qty	Art.	Thickness	Colour	Qty
<b>GTUP2</b>	2	Transparent	1 m	<b>GTUP5G</b>	5	Embossed	1 m
<b>GTUP3</b>	3	Transparent	1 m	<b>GTUP6G</b>	6	Embossed	1 m
<b>GTUP4</b>	4	Transparent	1 m	<b>GTUP2N</b>	2	Black	1 m
<b>GTUP5</b>	5	Transparent	1 m	<b>GTUP3N</b>	3	Black	1 m
<b>GTUP6</b>	6	Transparent	1 m	<b>GTUP4N</b>	4	Black	1 m
<b>GTUP2G</b>	2	Embossed	1 m	<b>GTUP5N</b>	5	Black	1 m
<b>GTUP3G</b>	3	Embossed	1 m	<b>GTUP6N</b>	6	Black	1 m
<b>GTUP4G</b>	4	Embossed	1 m				

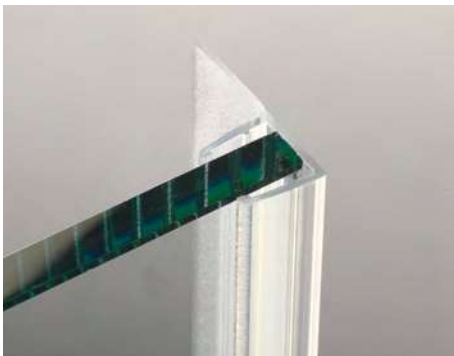

**GASKET WITH SHORT SIDE LIP**

Material: Co-extruded rigid and soft PVC

Fungicide to prevent mould from forming

Colour: transparent, embossed lip

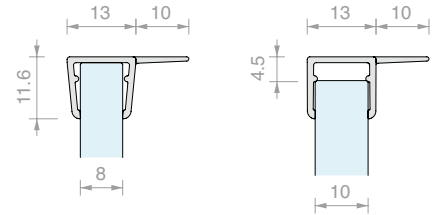

Art.	Length	For glass	Qty
<b>GM01410</b>	2000 mm	From 8 to 10 mm	1 Pc
<b>GM0141022</b>	2200 mm	From 8 to 10 mm	1 Pc
<b>GM0141025</b>	2500 mm	From 8 to 10 mm	1 Pc

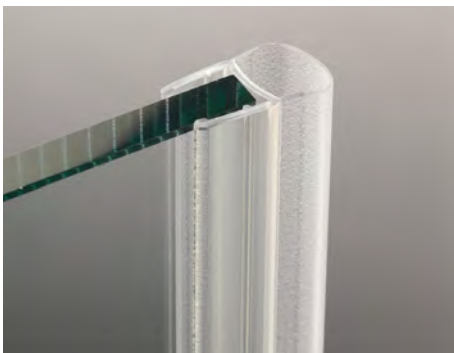

**BALLOON GASKET**

Material: Co-extruded rigid and soft PVC - Resistant to UV rays

Colour: transparent/\*black, transparent balloon

Art.	Length	For glass	Qty
<b>GM06</b>	2000 mm	From 8 to 10 mm	1 Pc
<b>GM0622</b>	2200 mm	From 8 to 10 mm	1 Pc
<b>GM0622NR*</b>	2200 mm	From 8 to 10 mm	1 Pc
<b>GM0625</b>	2500 mm	From 8 to 10 mm	1 Pc
<b>GM0625NR*</b>	2500 mm	From 8 to 10 mm	1 Pc
<b>GM063000</b>	3000 mm	From 8 to 10 mm	1 Pc
<b>GM063000NR*</b>	3000 mm	From 8 to 10 mm	1 Pc

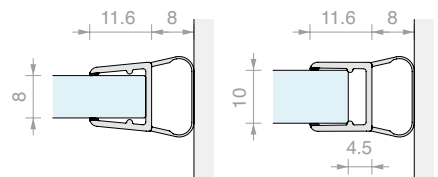

**HANDLE WITH VHB FIXING**

Material: AISI 304 steel

Finish: /8 /15

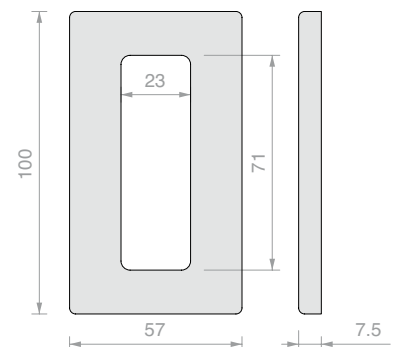

Art.	Qty
<b>HAND10057VHB</b>	1 Pc

# HINGED SHOWERS





**SQUARE**  
Page 158



**SQUARE ACCESSORIES**  
Page 201

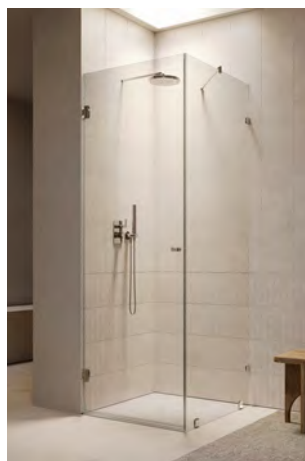

**CHD**  
Page 246



**CHD ACCESSORIES**  
Page 281

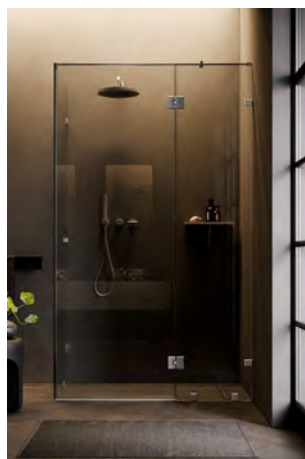

**CER**  
Page 312



**CER ACCESSORIES**  
Page 339

# SQUARE

## *Design*

Aesthetics, technology, and functionality. This is what makes the SQUARE series one of the highest-performance product lines.

The clean design with its square lines enhances every application requiring the utmost transparency and cleanliness. The different finishes and TÜV mark make each creation unique and reliable.

Suitable for glass thicknesses from 6 to 12 mm, the SQUARE range offers standard configurations as well as numerous opportunities for customisation thanks to the hinges, locks, knobs, clamps, and stabilizer bars, which can be combined to adapt to any type of request.

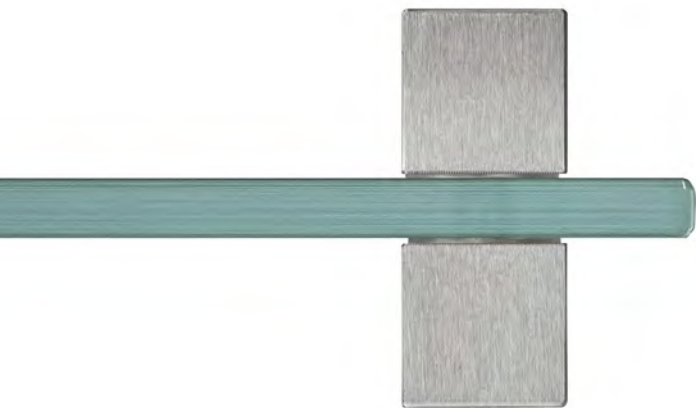



*/1*  
Chrome



*/2*  
Gold



*/4*  
Bronze



*/24*  
Brushed steel effect



*/R2*  
RAL9005 matt black

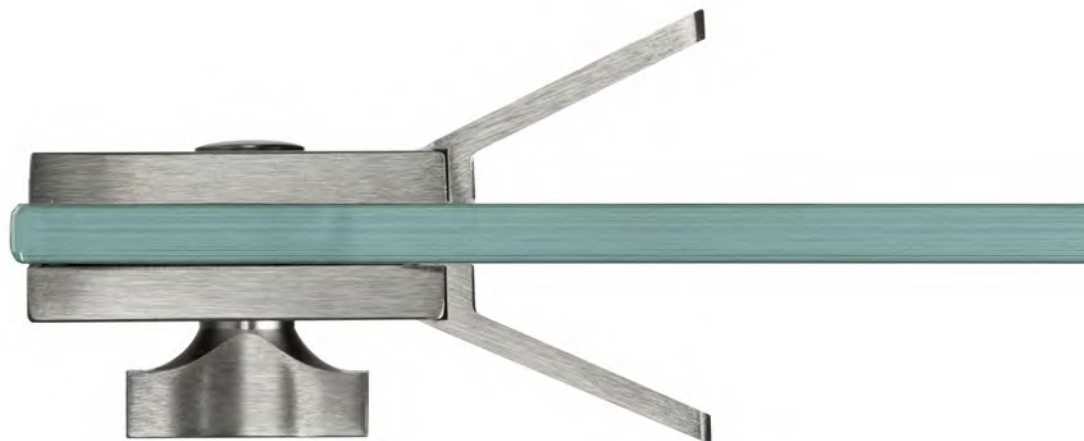
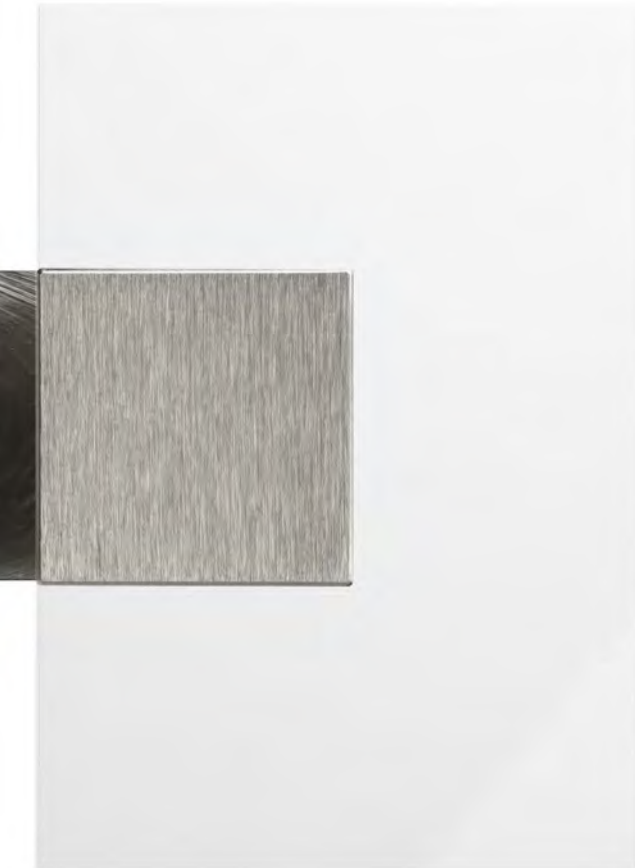

# SQUARE

## DQ Hinges

DQ hinges are the functional heart of the HD SQUARE SERIES.  
The hinge body is made of cast brass, while the components are mechanically processed.



Cap on one side to cover the screws fixing the hinge on the glass.



Adhesive seals to facilitate positioning of the hinge on the glass.

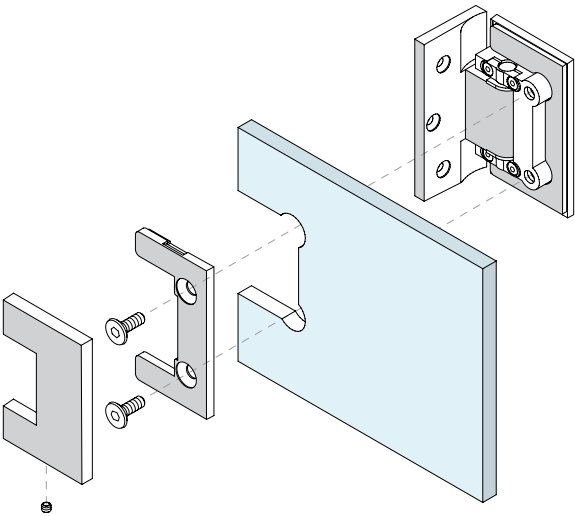



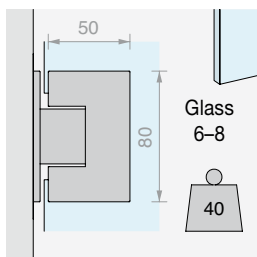
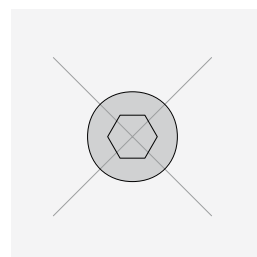
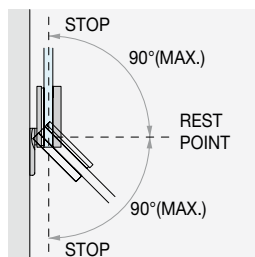
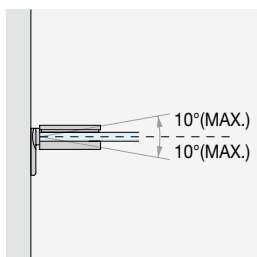
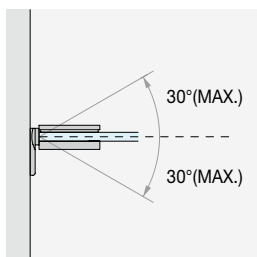
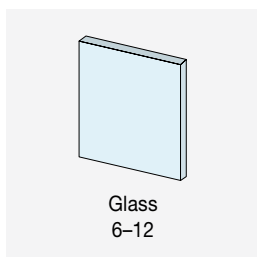

**CLOSING RETURN**  
Automatic return to the zero position in the last 30°.

**CORRECTION 10°**  
Correction of the door angle  $\pm 10^\circ$  upon installation.

**ANGLE OF ROTATION**  
Angle of rotation from  $+90^\circ$  to  $-90^\circ$ .  
With rest point at  $0^\circ$  and stops at  $-90^\circ$  and  $+90^\circ$ .

**NO VISIBLE SCREWS**

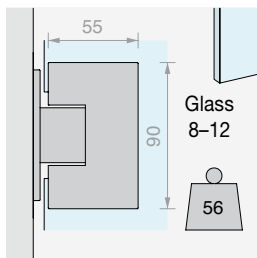

**TWO VERSIONS FOR GLASS WITH THICKNESS FROM 6 TO 12 mm**

The HD SQUARE SERIES can be used for glass with thickness from 6 to 12 mm thanks to hinges and locks in two versions, small and large. Depending on the chosen glass, it is possible to select the related hinge.

Adhesive finishing  
screw-cover cap

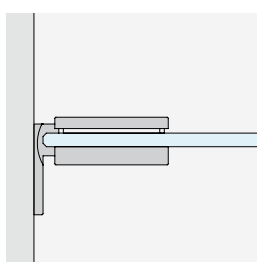

**WALL/GLASS**  
with side plate

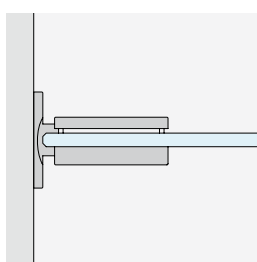

**WALL/GLASS**  
with central plate

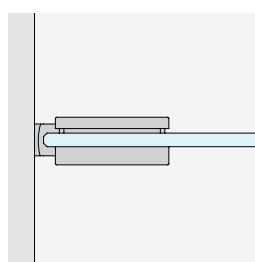

**WALL/GLASS**  
for narrow jambs

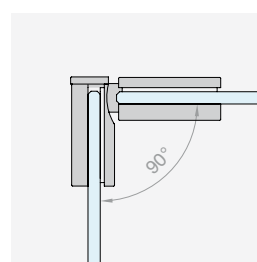

**GLASS/GLASS**  
90° corner

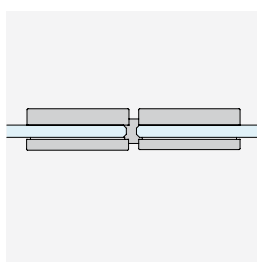

**GLASS/GLASS**  
in-line

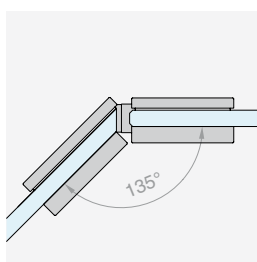

**GLASS/GLASS**  
135° corner

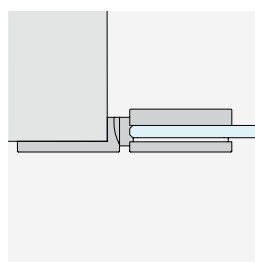

**WALL/GLASS**  
with in-line plate

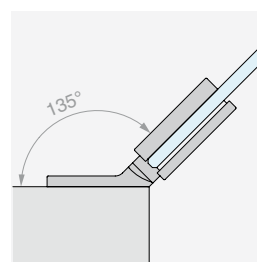

**WALL/GLASS**  
with plate at 135°



# SQUARE

*Kits*

## CONFIGURATIONS WITH HINGED DOORS

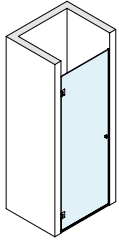

Page 165

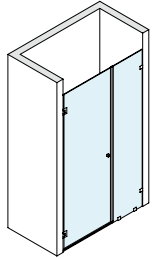

Page 169

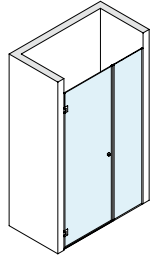

Page 173

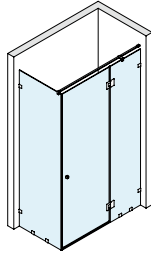

Page 177

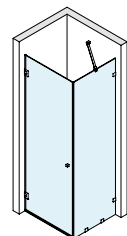

Page 181

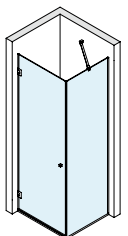

Page 185

## WALK-IN CONFIGURATIONS

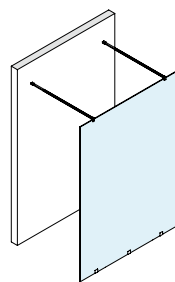

Page 189

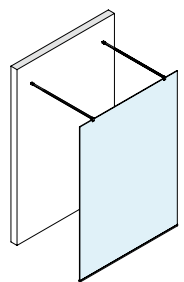

Page 191

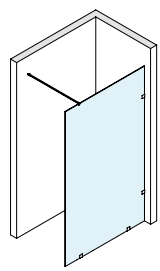

Page 193

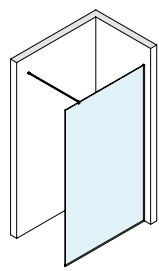

Page 195

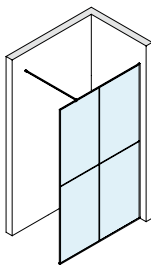

Page 197

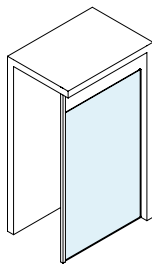

Page 199



**WALL/WALL HINGED  
SHOWER KIT**



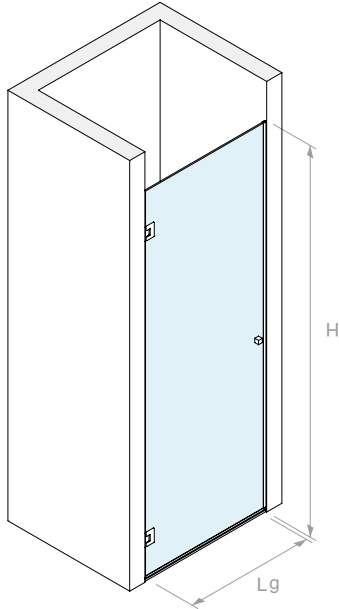

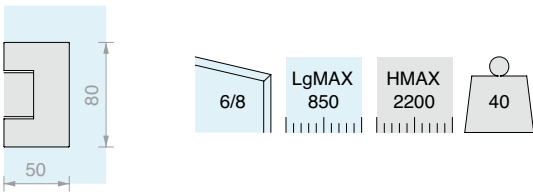

Finish:     



VERSION WITH HINGE **DQ30COV** 50 mm x 80 mm







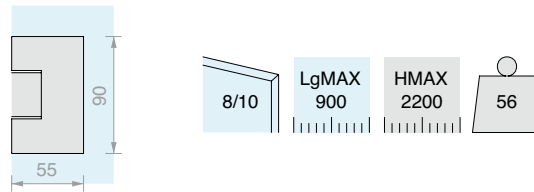

Kit comprising:

Art.	Description	Qty.	
<b>DQ30COV</b>	Adjustable side hinge	2 Pcs	
<b>PESQ0810B.100</b>	Water barrier profile	1 Pc	
<b>GM6010</b>	Gasket with drip flap	1 Pc	
<b>GM62</b>	Balloon gasket	2 Pcs	
<b>DQP2525</b>	Pair of knobs	1 Pc	

VERSION WITH HINGE **DQ40COV** 55 mm x 90 mm



Kit comprising:

Art.	Description	Qty.	
<b>DQ40COV</b>	Adjustable side hinge	2 Pcs	
<b>PESQ0810B.100</b>	Water barrier profile	1 Pc	
<b>GM0210</b>	Gasket with drip flap	1 Pc	
<b>GM0622</b>	Balloon gasket	2 Pcs	
<b>DQP2525</b>	Pair of knobs	1 Pc	

Art. **BDSQ6801** Qty 1 Pc

Art. **BDSQ81001** Qty 1 Pc

GLASS PANE DIMENSIONS

**BDSQ6801**

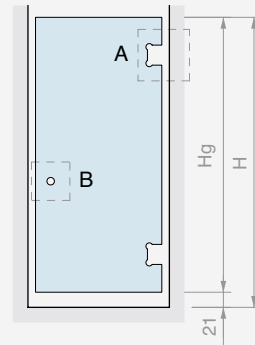
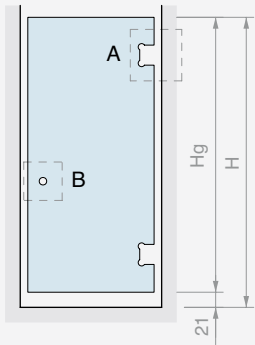

$H_g = H - 21$   
 $L_g (\text{MAX } 850) = LV - 16$

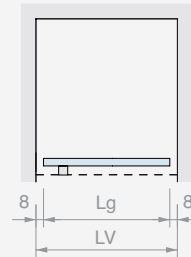
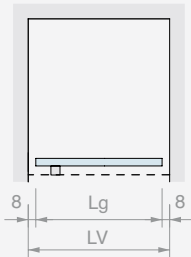

$H_g = H - 21$   
 $L_g (\text{MAX } 850) = LV - 16$

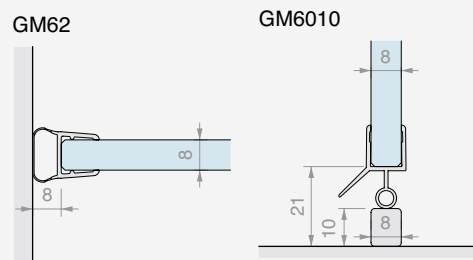
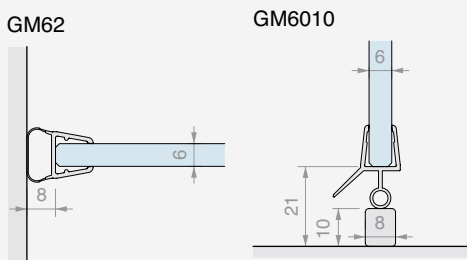
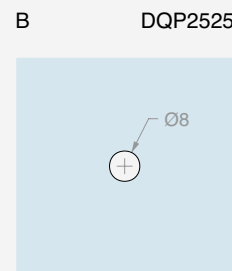
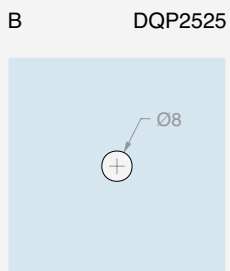
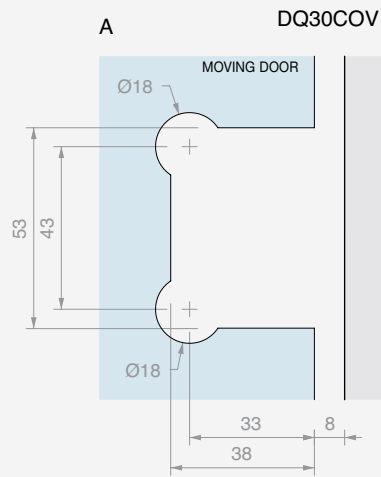
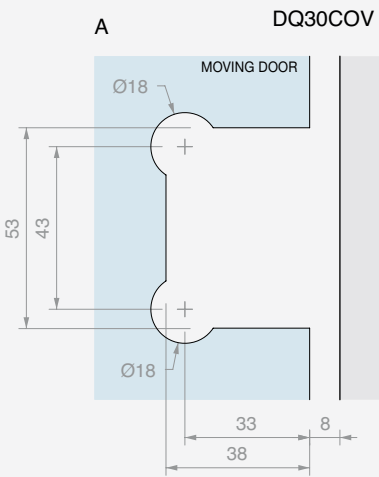

GLASS PANE DIMENSIONS

BDSQ81001

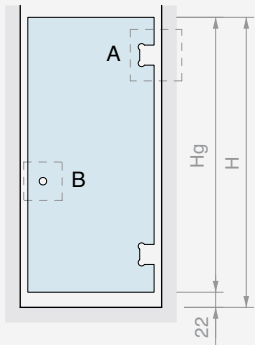

$H_g = H - 22$   
 $L_g (\text{MAX } 900) = LV - 16$

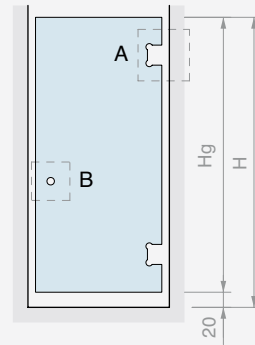
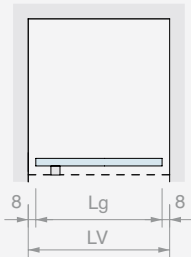

$H_g = H - 20$   
 $L_g (\text{MAX } 900) = LV - 23$

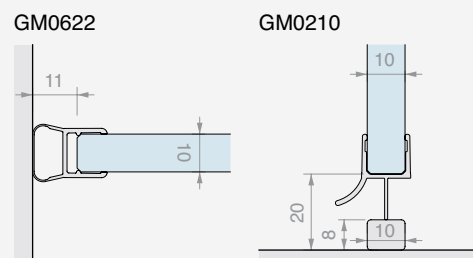
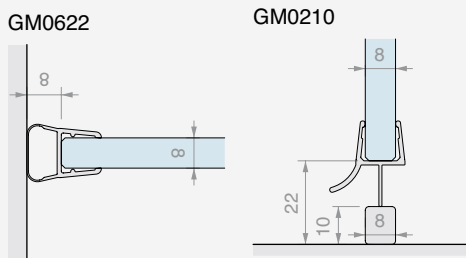
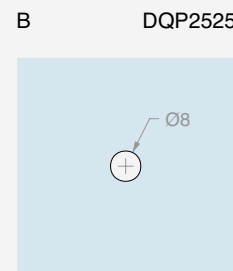
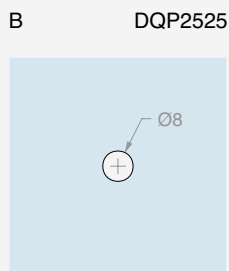
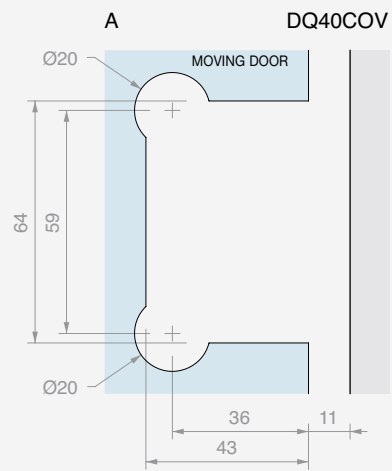
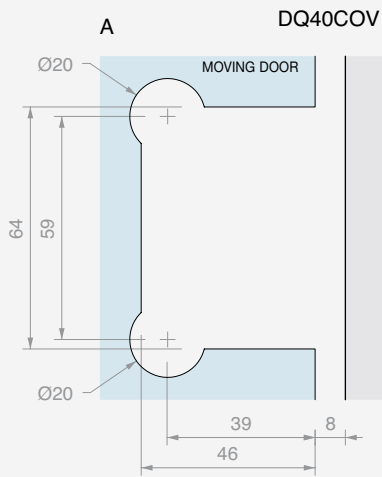
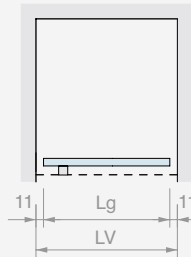





**WALL/WALL HINGED  
SHOWER KIT WITH FIXED PANE AND CLAMPS**



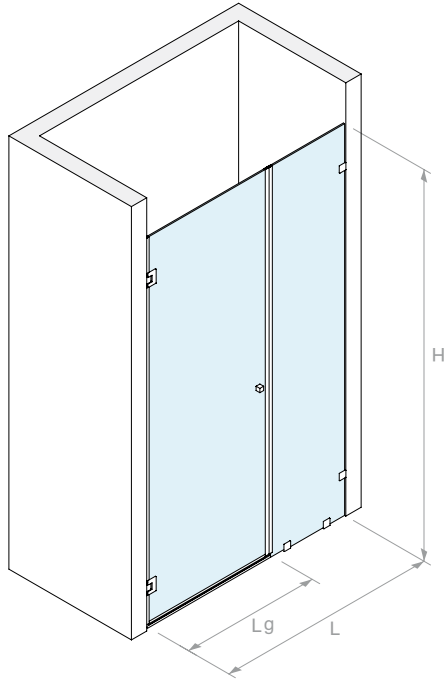



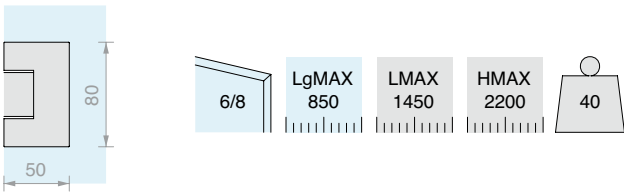



Finish:     



VERSION WITH HINGE **DQ30COV** 50 mm x 80 mm

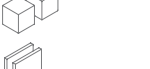







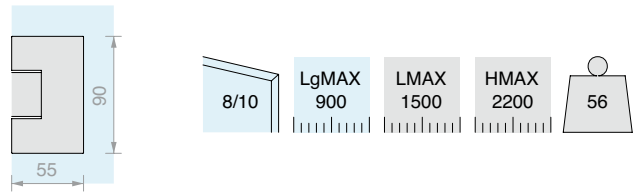



Kit comprising:

Art.	Description	Qty.	
<b>DQ30COV</b>	Adjustable side hinge	2 Pcs	
<b>PESQ0810B.100</b>	Water barrier profile	1 Pc	
<b>GM6010</b>	Gasket with drip flap	1 Pc	
<b>GM12SX22</b>	Magnetic 45° gasket	1 Pc	
<b>GM12DX22</b>	Magnetic 45° gasket	1 Pc	
<b>GM62</b>	Balloon gasket	1 Pc	
<b>DQP2525</b>	Pair of knobs	1 Pc	
<b>DQM41</b>	Clamp flush to the wall	4 Pcs	
Optional			
<b>DQA55</b>	Jointed stabilizer bar	1 Pc	

VERSION WITH HINGE **DQ40COV** 55 mm x 90 mm

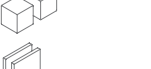

Kit comprising:

Art.	Description	Qty.	
<b>DQ40COV</b>	Adjustable side hinge	2 Pcs	
<b>PESQ0810B.100</b>	Water barrier profile	1 Pc	
<b>GM0210</b>	Gasket with drip flap	1 Pc	
<b>GM1520SX</b>	Magnetic 45° gasket	1 Pc	
<b>GM1520DX</b>	Magnetic 45° gasket	1 Pc	
<b>GM0622</b>	Balloon gasket	1 Pc	
<b>DQP2525</b>	Pair of knobs	1 Pc	
<b>DQM41</b>	Clamp flush to the wall	4 Pcs	
Optional			
<b>DQA55</b>	Jointed stabilizer bar	1 Pc	

Art.	Qty
<b>BDSQ6803</b>	1 Pc

Art.	Qty
<b>BDSQ81003</b>	1 Pc

GLASS PANE DIMENSIONS

BDSQ6803

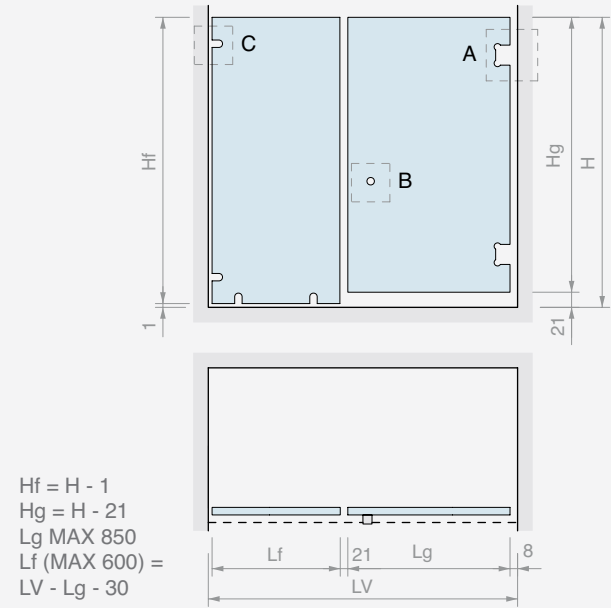

A DQ30COV

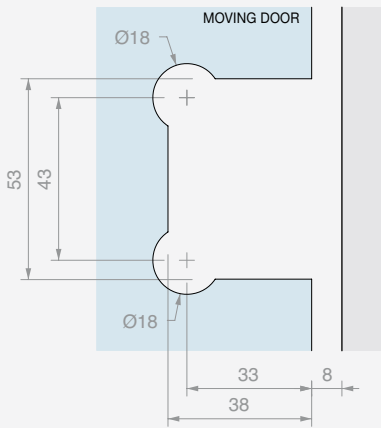

B DQP2525 C DQM41

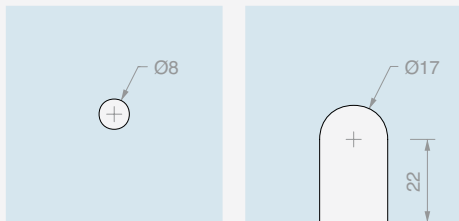

GM12SX22  
GM12DX22

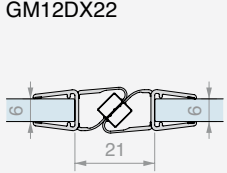

GM6010

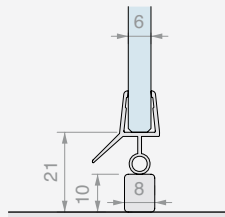

GM62

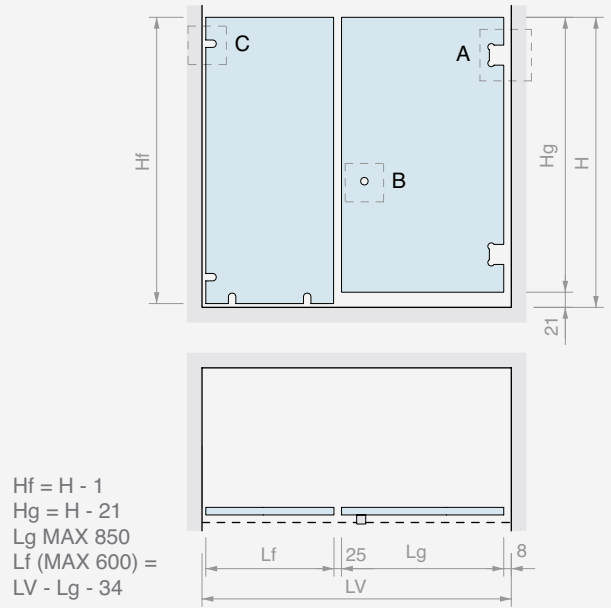
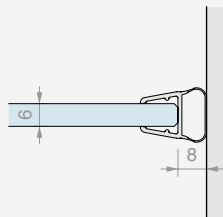

A DQ30COV

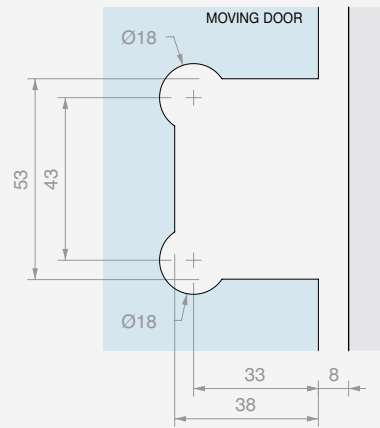

B DQP2525 C DQM41

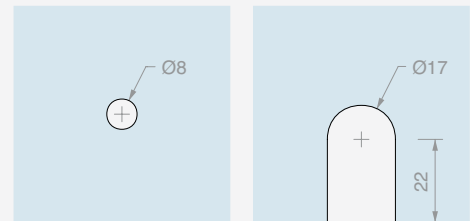

GM12SX22  
GM12DX22

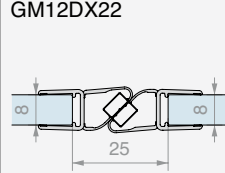

GM6010

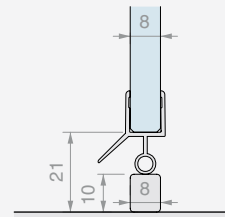

GM62

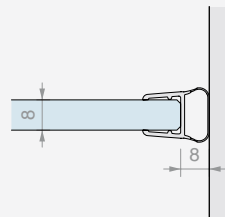

GLASS PANE DIMENSIONS

BDSQ81003

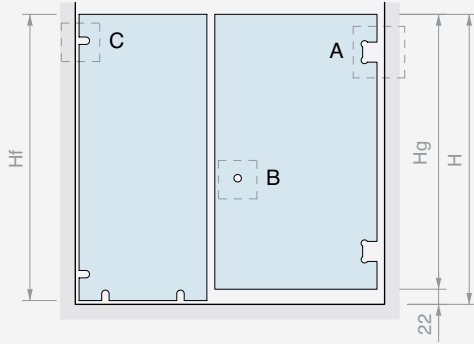

$H_f = H - 1$   
 $H_g = H - 22$   
 $L_g \text{ MAX } 900$   
 $L_f (\text{MAX } 800) = LV - L_g - 26$

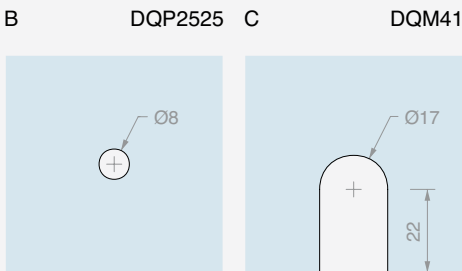
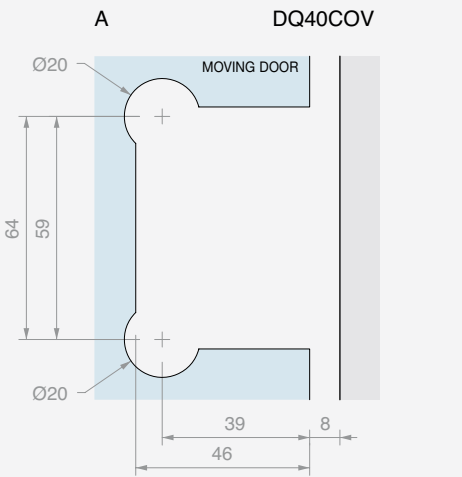
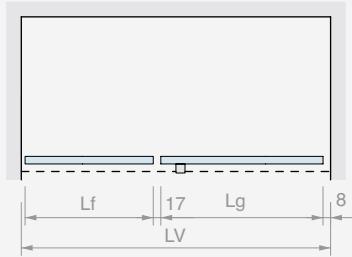

GM1520SX  
GM1520DX

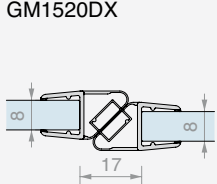

GM0210

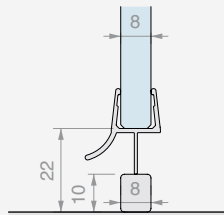

GM0622

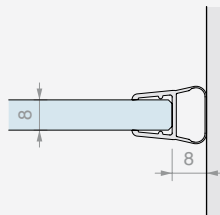

GM1520SX  
GM1520DX

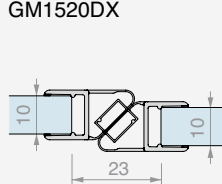

GM0210

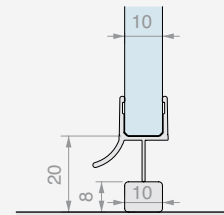

GM0622

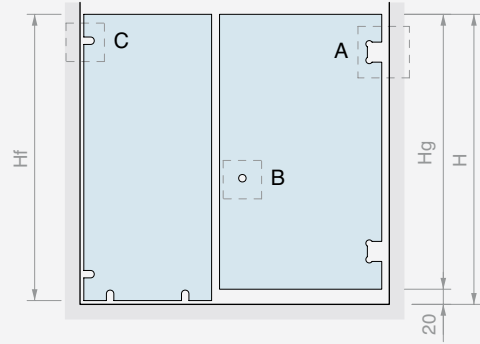
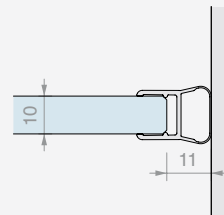

$H_f = H - 1$   
 $H_g = H - 20$   
 $L_g \text{ MAX } 900$   
 $L_f (\text{MAX } 800) = LV - L_g - 35$

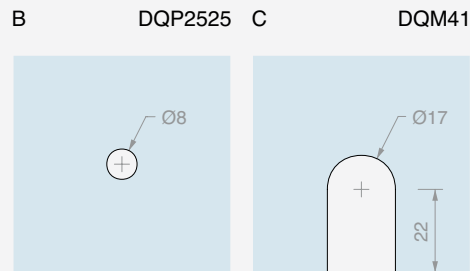
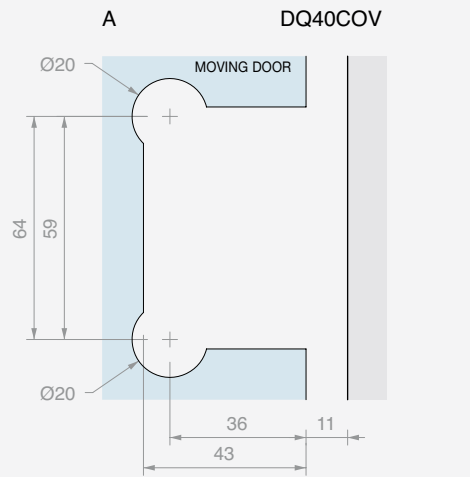
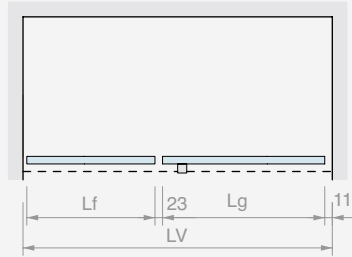



**WALL/WALL HINGED  
SHOWER KIT WITH FIXED PANE AND PROFILES**



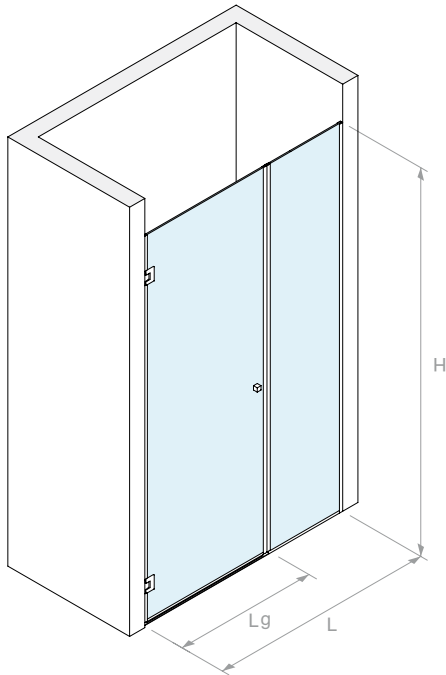



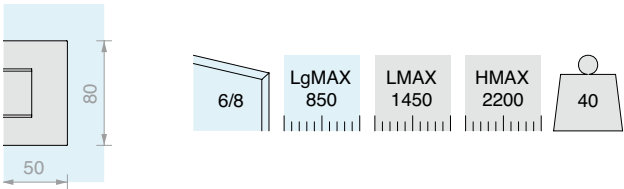





Finish:     



VERSION WITH HINGE **DQ30COV** 50 mm x 80 mm



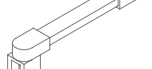

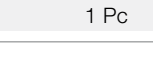



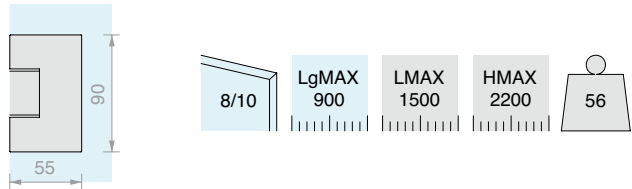





Kit comprising:

Art.	Description	Qty.	
<b>DQ30COV</b>	Adjustable side hinge	2 Pcs	
<b>LMU20B.220</b>	U-shaped profile	1 Pc	
<b>LMU20B.150</b>	U-shaped profile	1 Pc	
<b>LMU86B.100</b>	Flat upper profile	1 Pc	
<b>GTUP4</b>	Glass holder gasket	4 m	
<b>GTUP6</b>	Glass holder gasket	4 m	
<b>GM6010</b>	Gasket with drip flap	1 Pc	
<b>GM12SX22</b>	Magnetic 45° gasket	1 Pc	
<b>GM12DX22</b>	Magnetic 45° gasket	1 Pc	
<b>GM62</b>	Balloon gasket	1 Pc	
<b>DQP2525</b>	Pair of knobs	1 Pc	
Optional			
<b>DQA55</b>	Jointed stabilizer bar	1 Pc	
Art.		Qty	
<b>BDSQ6805</b>		1 Pc	

VERSION WITH HINGE **DQ40COV** 55 mm x 90 mm

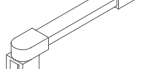

Kit comprising:

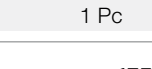
Art.	Description	Qty.	
<b>DQ40COV</b>	Adjustable side hinge	2 Pcs	
<b>LMU20B.220</b>	U-shaped profile	1 Pc	
<b>LMU20B.150</b>	U-shaped profile	1 Pc	
<b>LMU86B.100</b>	Flat upper profile	1 Pc	
<b>GTUP4</b>	Glass holder gasket	4 m	
<b>GTUP2</b>	Glass holder gasket	4 m	
<b>GM0210</b>	Gasket with drip flap	1 Pc	
<b>GM1520SX</b>	Magnetic 45° gasket	1 Pc	
<b>GM1520DX</b>	Magnetic 45° gasket	1 Pc	
<b>GM0622</b>	Balloon gasket	1 Pc	
<b>DQP2525</b>	Pair of knobs	1 Pc	
Optional			
<b>DQA55</b>	Jointed stabilizer bar	1 Pc	
Art.		Qty	
<b>BDSQ81005</b>		1 Pc	

GLASS PANE DIMENSIONS

BDSQ6805

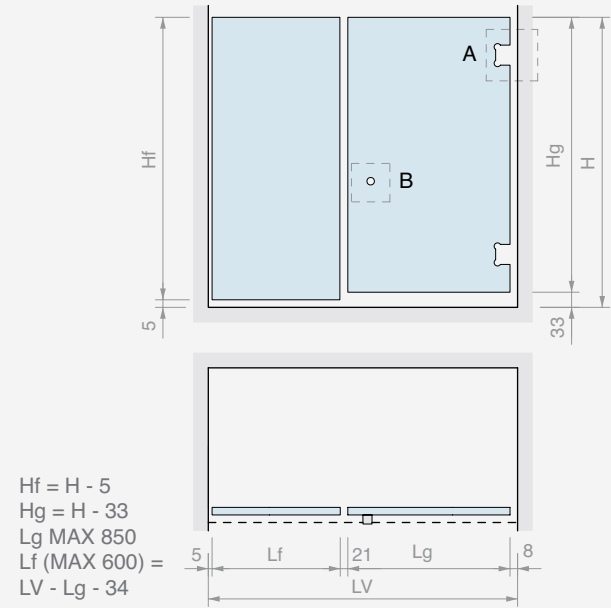

$H_f = H - 5$   
 $H_g = H - 33$   
 $L_g \text{ MAX } 850$   
 $L_f \text{ (MAX } 600) = 5 + L_f + 21 + L_g + 8$   
 $LV = L_g + 34$

A DQ30COV

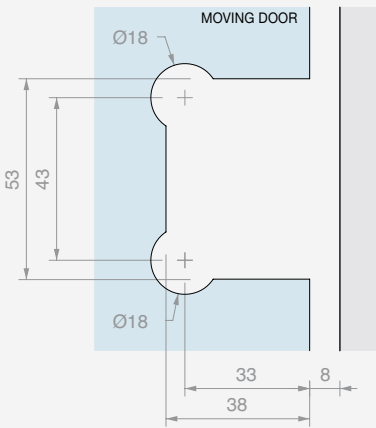

B DQP2525

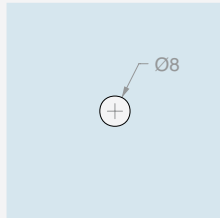

GM12SX22  
GM12DX22

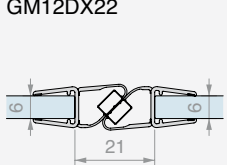

GM6010

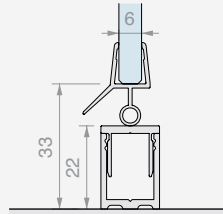

GM62

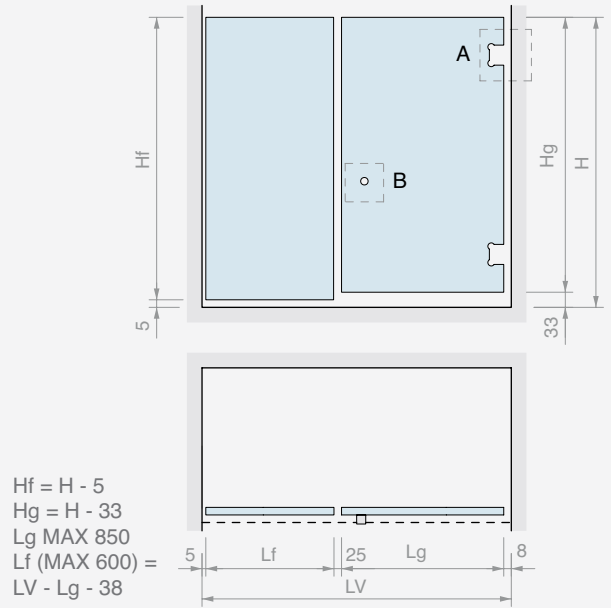
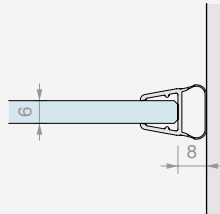

$H_f = H - 5$   
 $H_g = H - 33$   
 $L_g \text{ MAX } 850$   
 $L_f \text{ (MAX } 600) = 5 + L_f + 25 + L_g + 8$   
 $LV = L_g + 38$

A DQ30COV

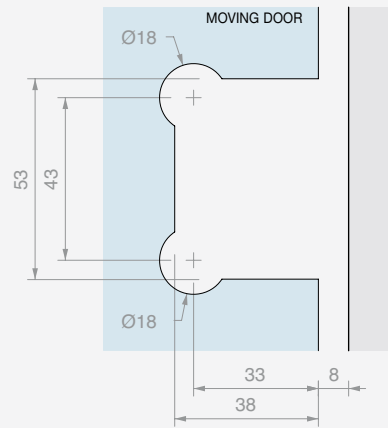

B DQP2525

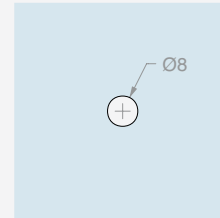

GM12SX22  
GM12DX22

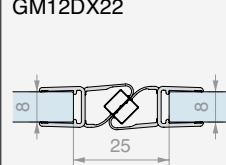

GM6010

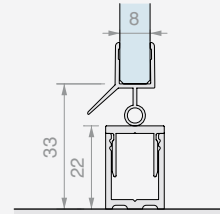

GM62

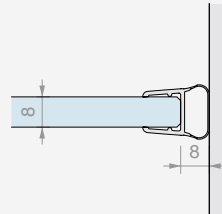

GLASS PANE DIMENSIONS

BDSQ81005

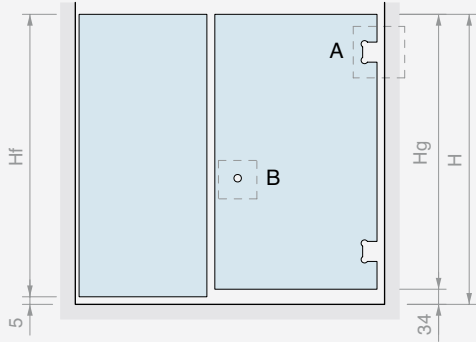

$H_f = H - 5$   
 $H_g = H - 34$   
 $L_g \text{ MAX } 900$   
 $L_f \text{ (MAX } 600) = 5 + L_f + 17 + L_g + 8$   
 $LV = L_g - 30$

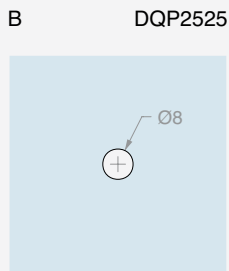
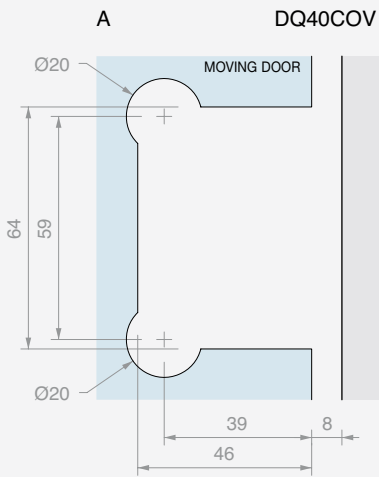
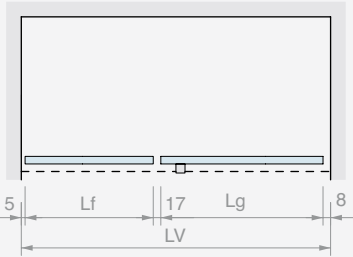

GM1520SX  
GM1520DX

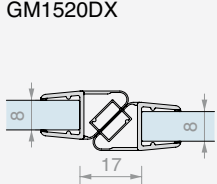

GM0210

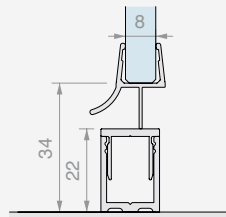

GM0622

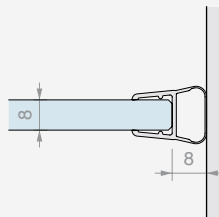

GM1520SX  
GM1520DX

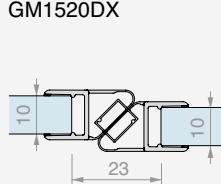

GM0210

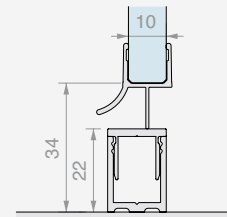

GM0622

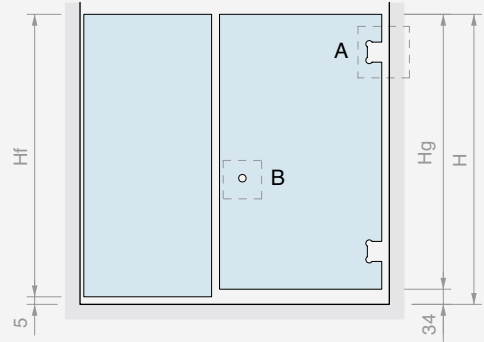
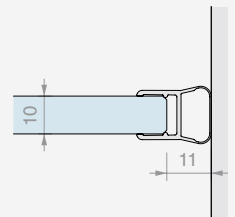

$H_f = H - 5$   
 $H_g = H - 34$   
 $L_g \text{ MAX } 900$   
 $L_f \text{ (MAX } 600) = 5 + L_f + 23 + L_g + 11$   
 $LV = L_g - 39$

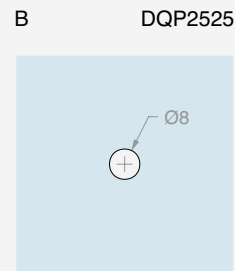
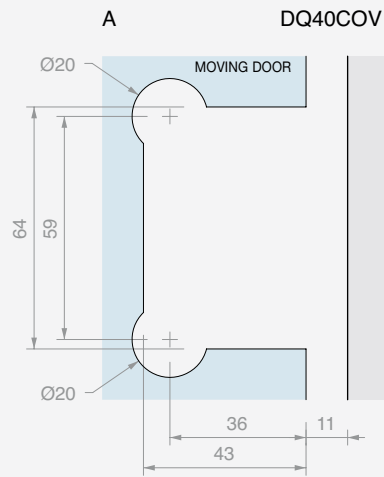
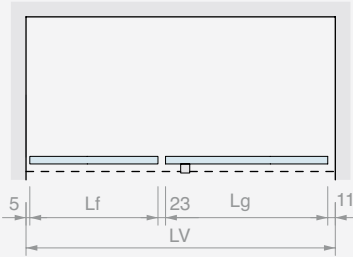





**WALL/GLASS HINGED SHOWER  
KIT WITH FIXED PANE AND CLAMPS**

Finish: 

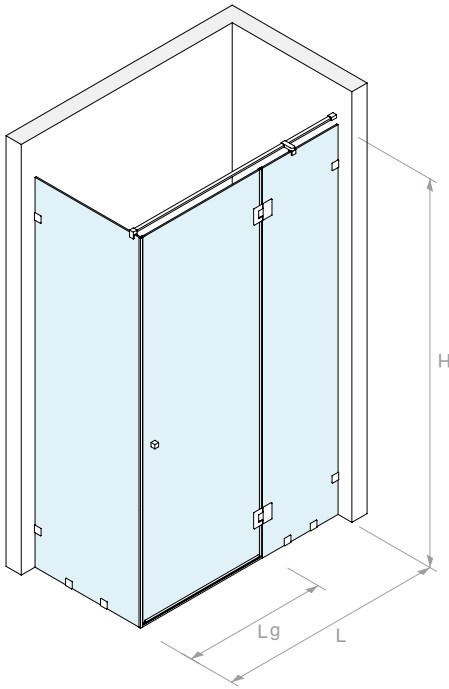



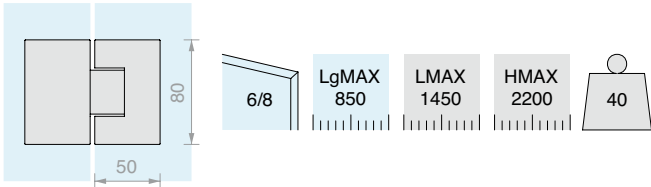



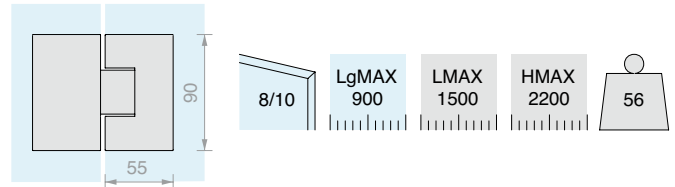



VERSION WITH HINGE **DQ380** 50 mm x 80 mm













VERSION WITH HINGE **DQ480** 55 mm x 90 mm



Kit comprising:

Art.	Description	Qty.	
<b>DQ380</b>	In-line adjustable hinge	2 Pcs	
<b>PESQ0810B.100</b>	Water barrier profile	1 Pc	
<b>GM6010</b>	Gasket with drip flap	1 Pc	
<b>GM58</b>	90° strike jamb gasket	1 Pc	
<b>GM62</b>	Balloon gasket	1 Pc	
<b>DQP2525</b>	Pair of knobs	1 Pc	
<b>DQT1500</b>	Fixed stabilizer bar	1 Pc	
<b>DQA90</b>	Distanced glass fixing	1 Pc	
<b>DQM41</b>	Clamp flush to the wall	8 Pcs	

Kit comprising:

Art.	Description	Qty.	
<b>DQ480</b>	In-line adjustable hinge	2 Pcs	
<b>PESQ0810B.100</b>	Water barrier profile	1 Pc	
<b>GM0210</b>	Gasket with drip flap	1 Pc	
<b>GM5422</b>	90° strike jamb gasket	1 Pc	
<b>GM0422</b>	Gasket with lip	1 Pc	
<b>DQP2525</b>	Pair of knobs	1 Pc	
<b>DQT1500</b>	Fixed stabilizer bar	1 Pc	
<b>DQA90</b>	Distanced glass fixing	1 Pc	
<b>DQM41</b>	Clamp flush to the wall	8 Pcs	

Art. **BDSQ6807** Qty 1 Pc

Art. **BDSQ81007** Qty 1 Pc

GLASS PANE DIMENSIONS

BDSQ6807

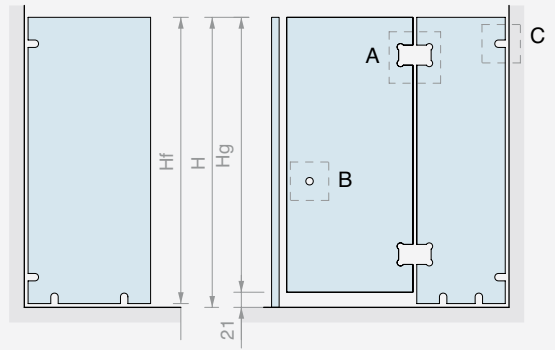
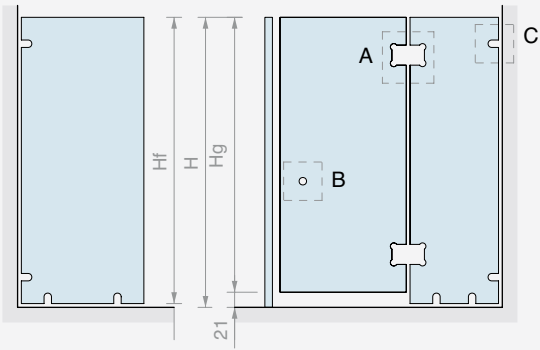

$H_f = H - 1$   
 $H_g = H - 21$   
 $L_g \text{ MAX } 850$   
 $L_f \text{ (MAX } 800) = PV - 6$   
 $L_{f1} \text{ (MAX } 600) = LV - L_g - 21$

$H_f = H - 1$   
 $H_g = H - 21$   
 $L_g \text{ MAX } 850$   
 $L_f \text{ (MAX } 800) = PV - 6$   
 $L_{f1} \text{ (MAX } 600) = LV - L_g - 23$

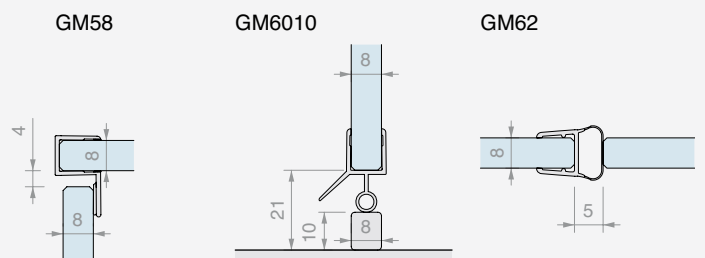
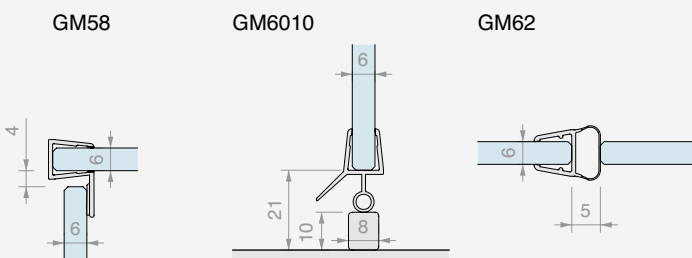
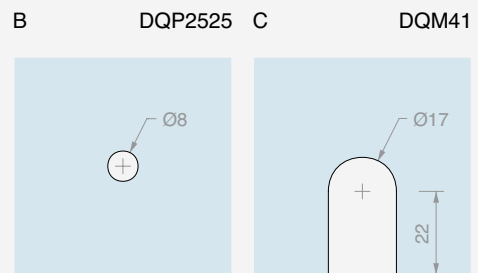
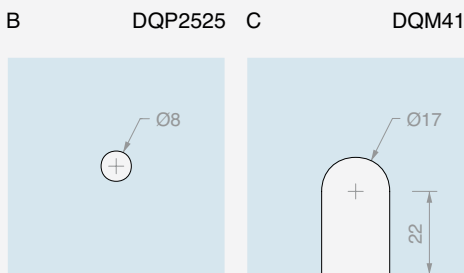
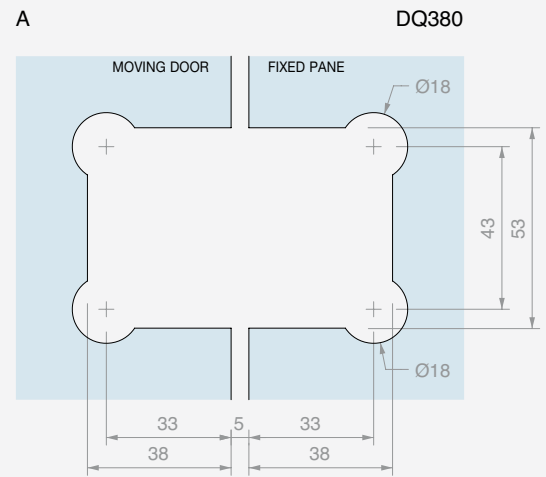
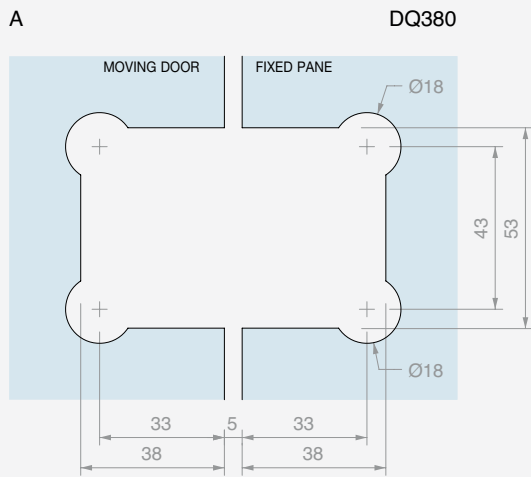

GLASS PANE DIMENSIONS

BDSQ81007



8

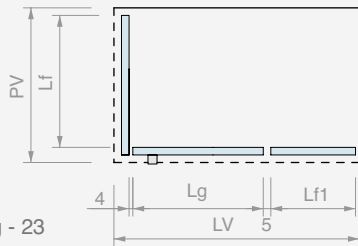
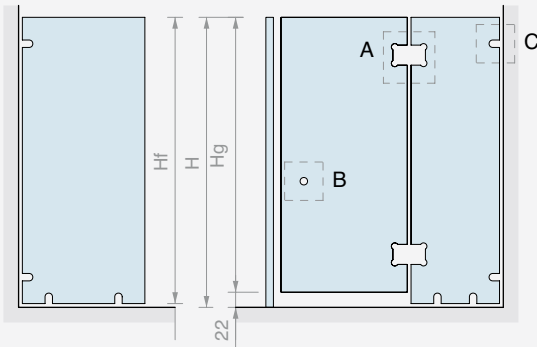

Hf = H - 1  
 Hg = H - 22  
 Lg MAX 900  
 Lf (MAX 800) = PV - 6  
 Lf1 (MAX 600) = LV - Lg - 23



10

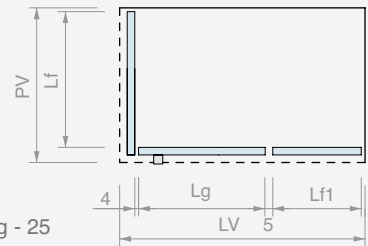
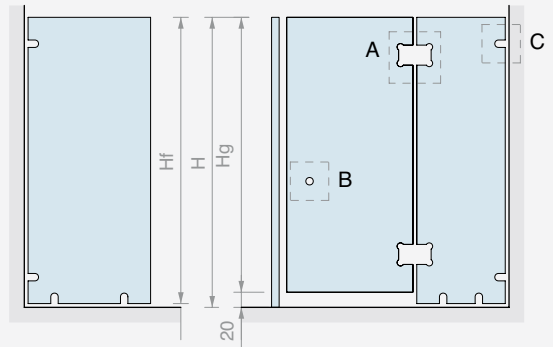

Hf = H - 1  
 Hg = H - 20  
 Lg MAX 900  
 Lf (MAX 800) = PV - 6  
 Lf1 (MAX 600) = LV - Lg - 25

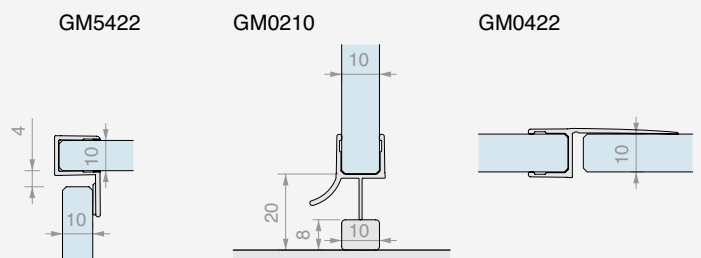
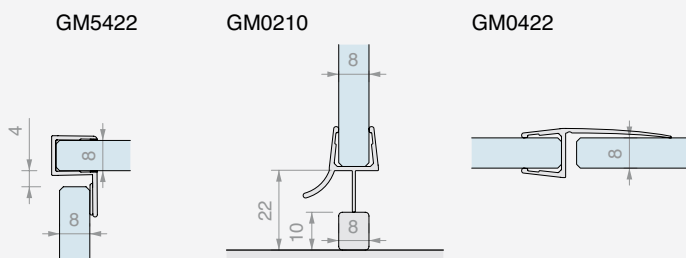
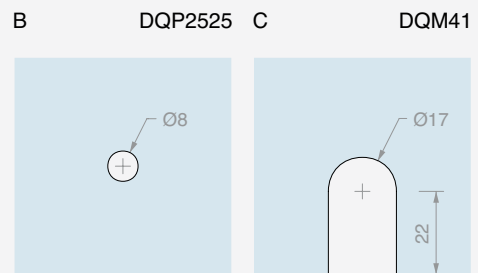
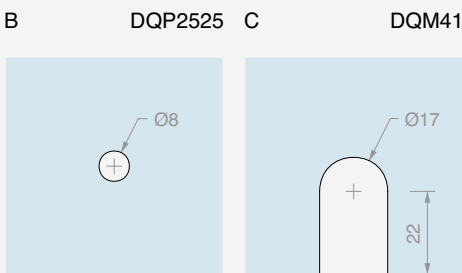
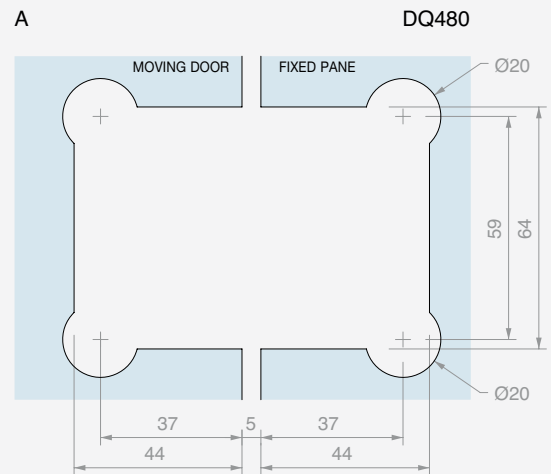
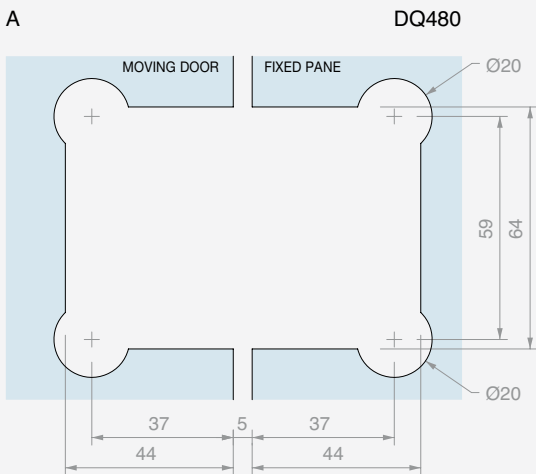



**WALL/WALL CORNER HINGED  
SHOWER KIT WITH FIXED PANE AND CLAMPS**



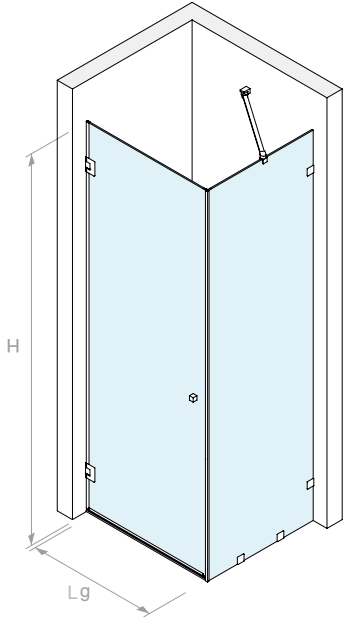



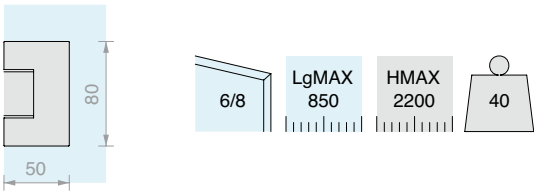

Finish:     



VERSION WITH HINGE **DQ30COV** 50 mm x 80 mm









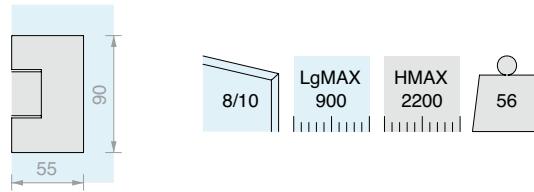

Kit comprising:

Art.	Description	Qty.	
<b>DQ30COV</b>	Adjustable side hinge	2 Pcs	
<b>PESQ0810B.100</b>	Water barrier profile	1 Pc	
<b>GM6010</b>	Gasket with drip flap	1 Pc	
<b>GM58</b>	90° strike jamb gasket	1 Pc	
<b>GM62</b>	Balloon gasket	1 Pc	
<b>DQP2525</b>	Pair of knobs	1 Pc	
<b>DQA55</b>	Jointed stabilizer bar	1 Pc	
<b>DQM41</b>	Clamp flush to the wall	4 Pcs	

VERSION WITH HINGE **DQ40COV** 55 mm x 90 mm



Kit comprising:

Art.	Description	Qty.	
<b>DQ40COV</b>	Adjustable side hinge	2 Pcs	
<b>PESQ0810B.100</b>	Water barrier profile	1 Pc	
<b>GM0210</b>	Gasket with drip flap	1 Pc	
<b>GM5422</b>	90° strike jamb gasket	1 Pc	
<b>GM0622</b>	Balloon gasket	1 Pc	
<b>DQP2525</b>	Pair of knobs	1 Pc	
<b>DQA55</b>	Jointed stabilizer bar	1 Pc	
<b>DQM41</b>	Clamp flush to the wall	4 Pcs	

Art. **BDSQ6813** Qty 1 Pc

Art. **BDSQ81013** Qty 1 Pc

GLASS PANE DIMENSIONS

**BDSQ6813**

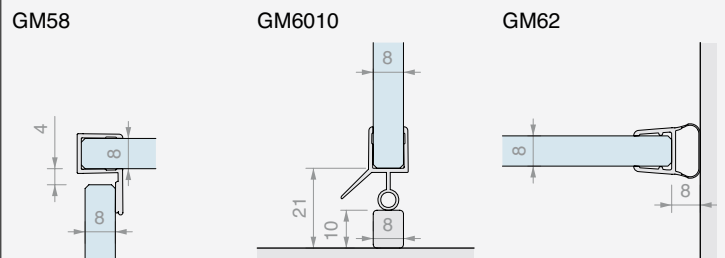
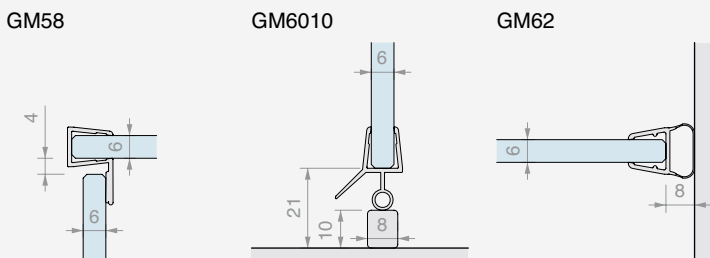
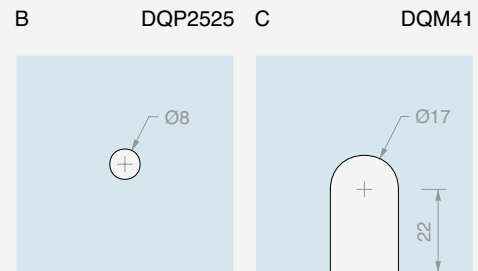
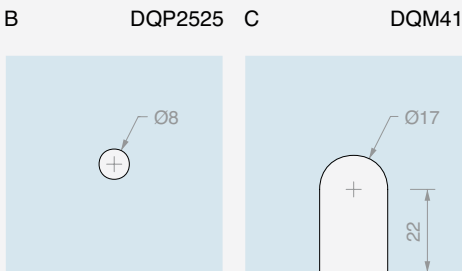
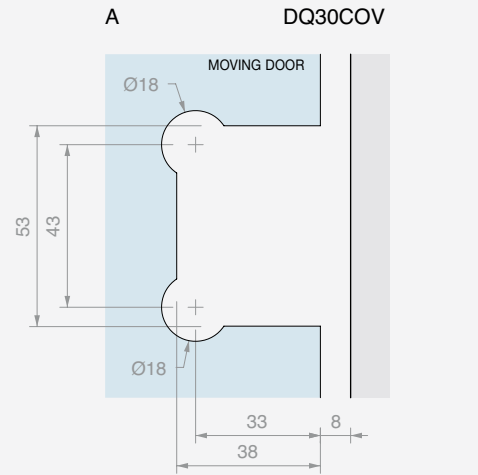
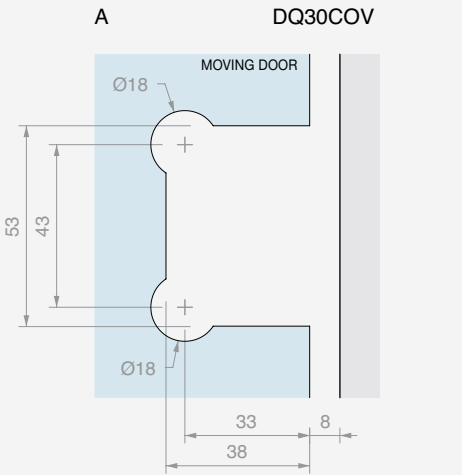
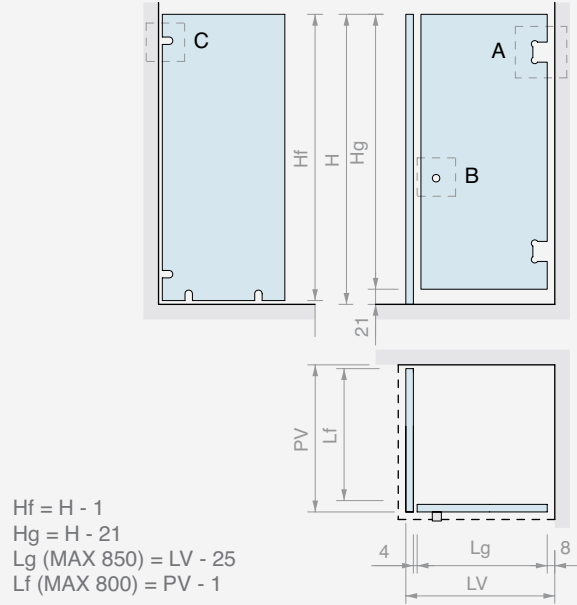
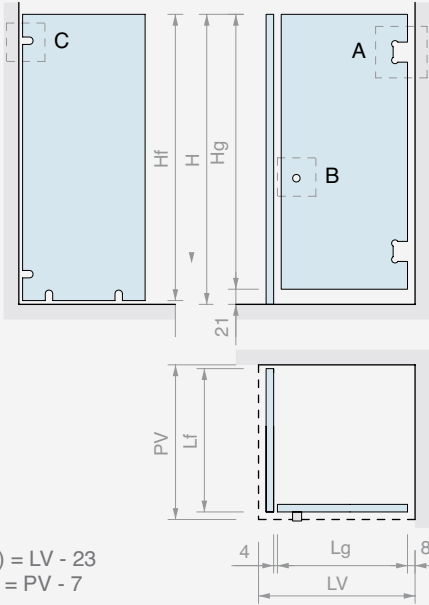

GLASS PANE DIMENSIONS

BDSQ81013

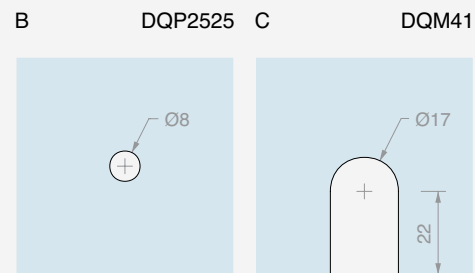
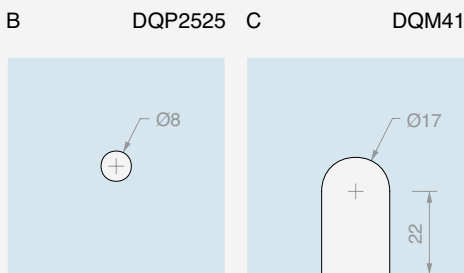
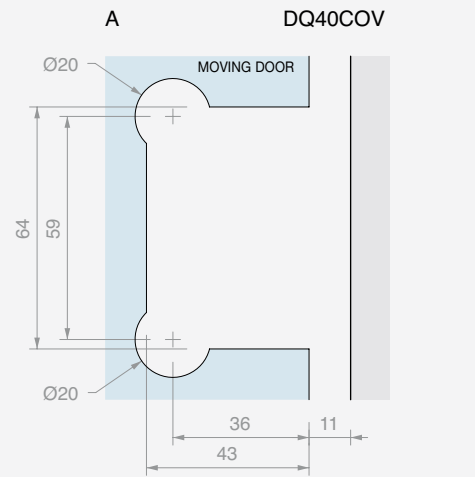
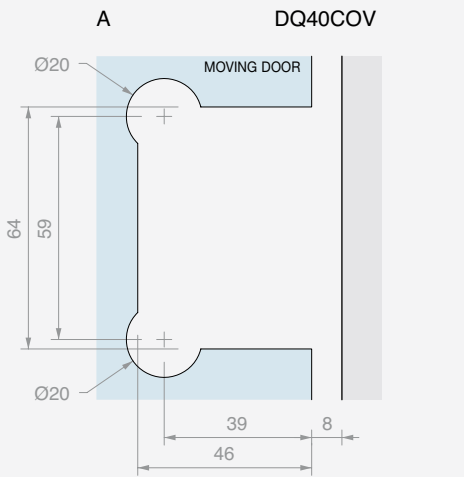
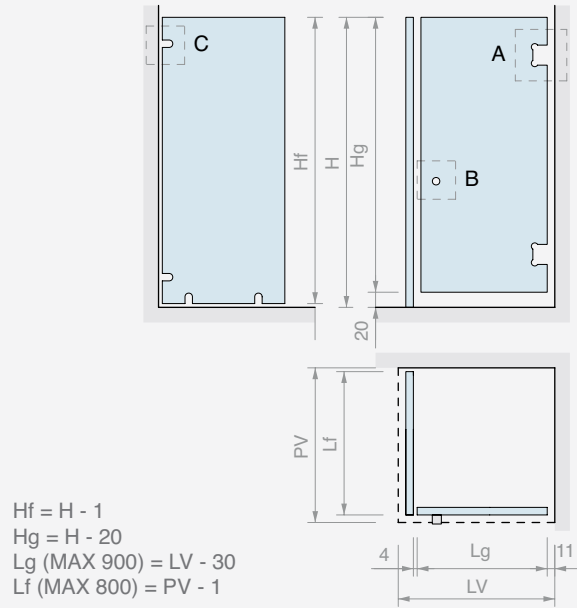
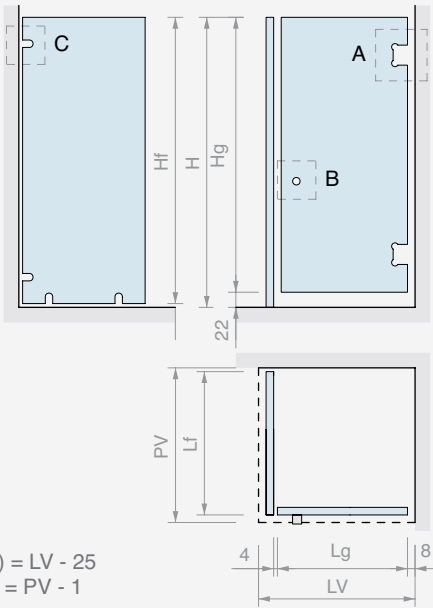

GM5422

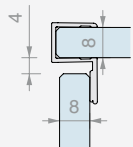

GM0210

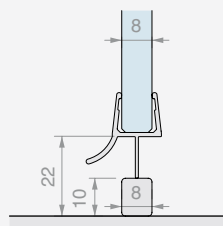

GM0622

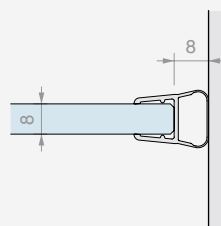

GM5422

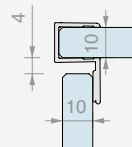

GM0210

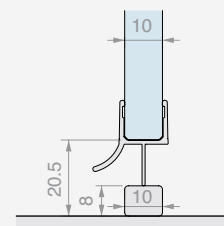

GM0622

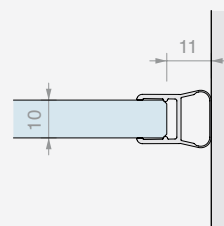





**WALL/WALL CORNER HINGED  
SHOWER KIT WITH FIXED PANE AND PROFILES**



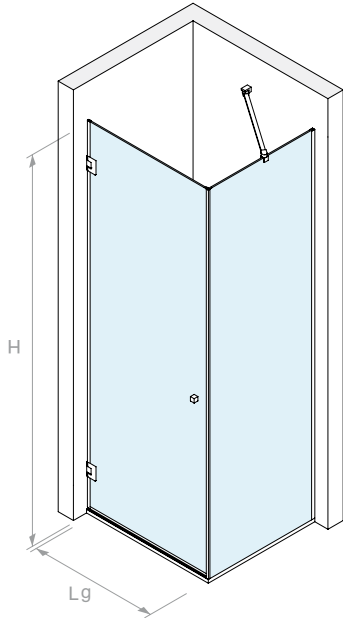



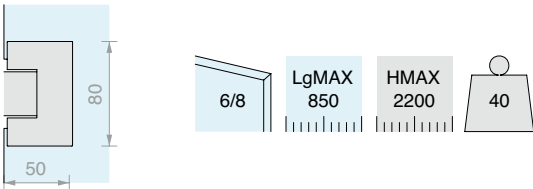



Finish:     



VERSION WITH HINGE **DQ30COV** 50 mm x 80 mm





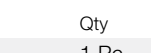



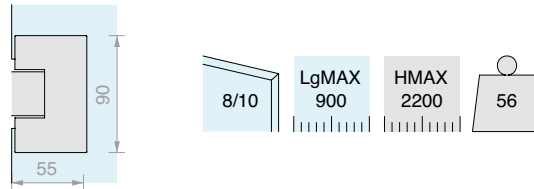



Kit comprising:

Art.	Description	Qty.	
<b>DQ30COV</b>	Adjustable side hinge	2 Pcs	
<b>LMU20B.220</b>	U-shaped profile	2 Pcs	
<b>LMU86B.100</b>	Flat upper profile	1 Pc	
<b>GTUP4</b>	Glass holder gasket	4 m	
<b>GTUP6</b>	Glass holder gasket	4 m	
<b>GM58</b>	90° strike jamb gasket	1 Pc	
<b>GM6010</b>	Gasket with drip flap	1 Pc	
<b>GM62</b>	Balloon gasket	1 Pc	
<b>DQP2525</b>	Pair of knobs	1 Pc	
<b>DQA55</b>	Jointed stabilizer bar	1 Pc	

VERSION WITH HINGE **DQ40COV** 55 mm x 90 mm



Kit comprising:

Art.	Description	Qty.	
<b>DQ40COV</b>	Adjustable side hinge	2 Pcs	
<b>LMU20B.220</b>	U-shaped profile	2 Pcs	
<b>LMU86B.100</b>	Flat upper profile	1 Pc	
<b>GTUP4</b>	Glass holder gasket	4 m	
<b>GTUP2</b>	Glass holder gasket	4 m	
<b>GM5422</b>	90° strike jamb gasket	1 Pc	
<b>GM0210</b>	Gasket with drip flap	1 Pc	
<b>GM0622</b>	Balloon gasket	1 Pc	
<b>DQP2525</b>	Pair of knobs	1 Pc	
<b>DQA55</b>	Jointed stabilizer bar	1 Pc	

Art. **BDSQ6815** Qty 1 Pc

Art. **BDSQ81015** Qty 1 Pc

GLASS PANE DIMENSIONS

**BDSQ6815**

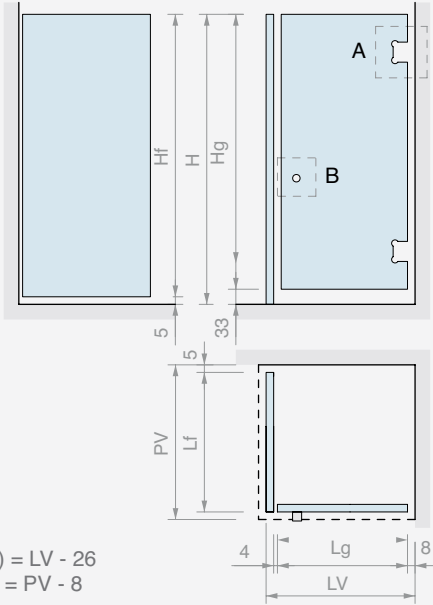

Hf = H - 5  
 Hg = H - 33  
 Lg (MAX 900) = LV - 26  
 Lf (MAX 800) = PV - 8

**A DQ30COV**

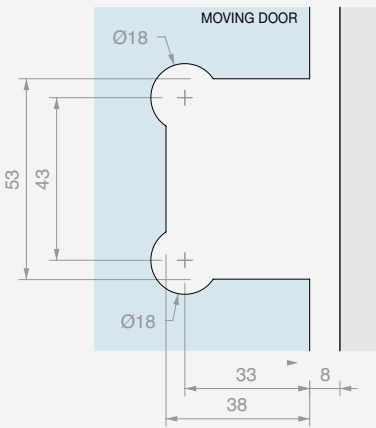

**B DQP2525**

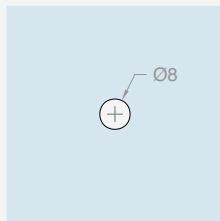

**GM58**

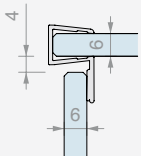

**GM6010**

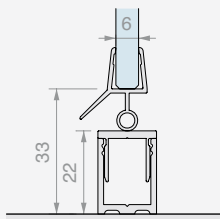

**GM62**

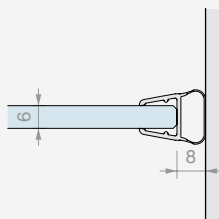

**GM58**

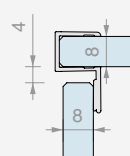

**GM6010**

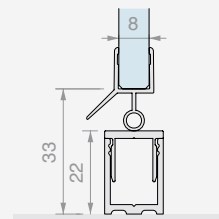

**GM62**

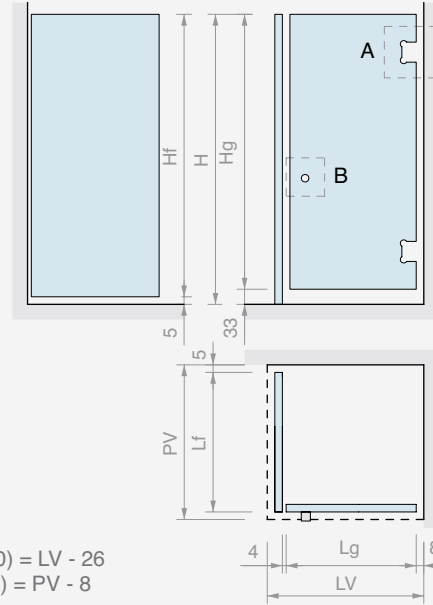
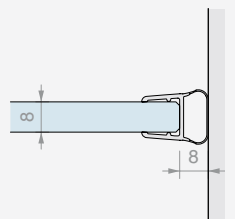

Hf = H - 5  
 Hg = H - 33  
 Lg (MAX 900) = LV - 26  
 Lf (MAX 900) = PV - 8

**A DQ30COV**

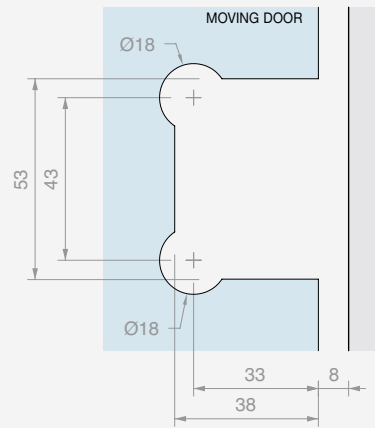

**B DQP2525**

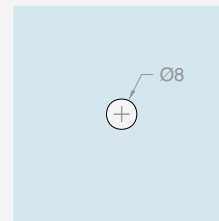

GLASS PANE DIMENSIONS

BDSQ81015

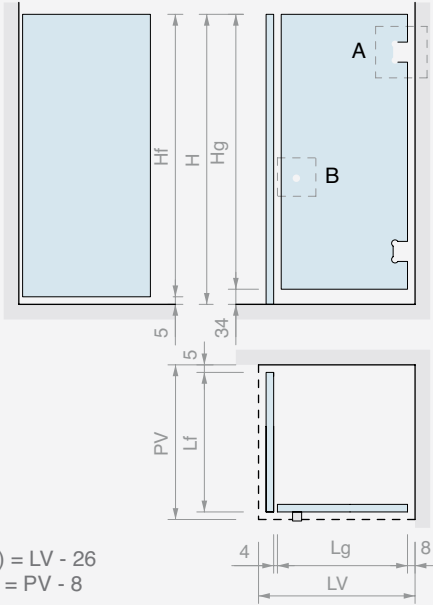

Hf = H - 5  
 Hg = H - 34  
 Lg (MAX 900) = LV - 26  
 Lf (MAX 800) = PV - 8

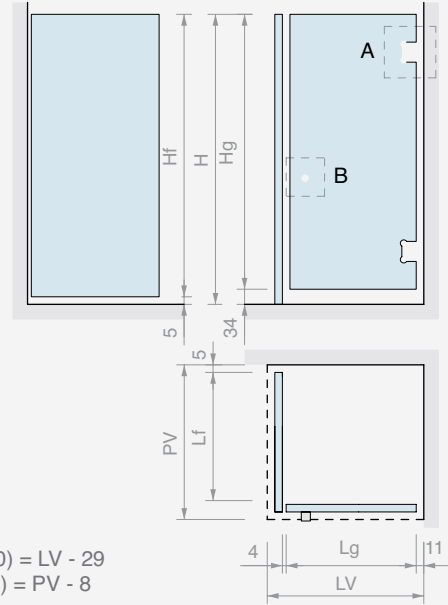

Hf = H - 5  
 Hg = H - 34  
 Lg (MAX 900) = LV - 29  
 Lf (MAX 800) = PV - 8

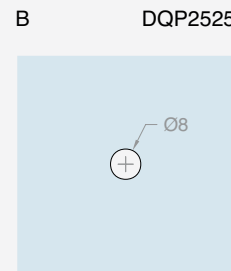
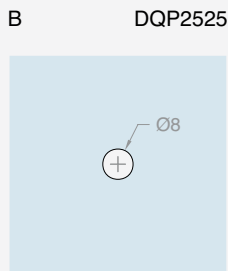
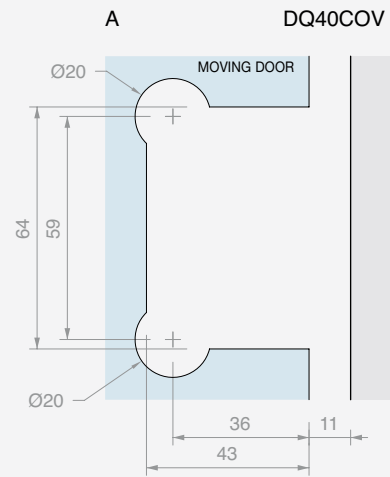
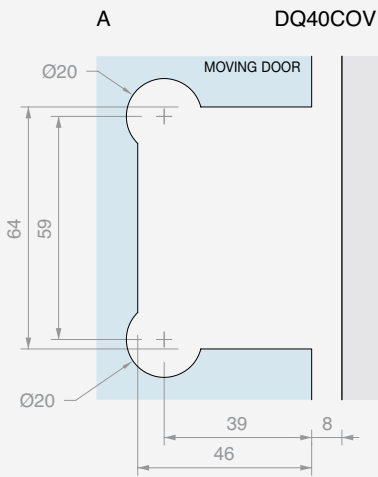

GM5422

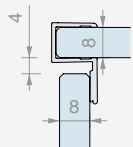

GM0210

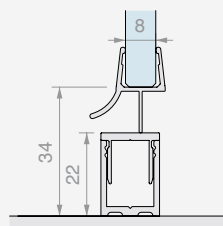

GM0622

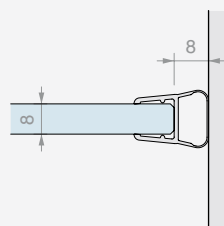

GM5422

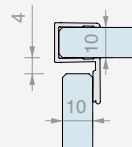

GM0210

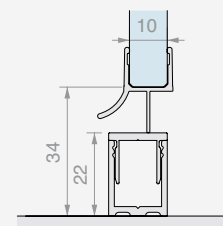

GM0622

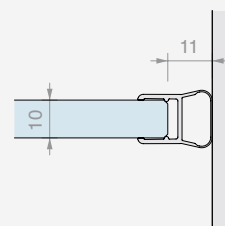



**TWO-SIDE WALK-IN  
SHOWER KIT WITH CLAMPS**

Finish: /1 /2 /4 /24 /R2

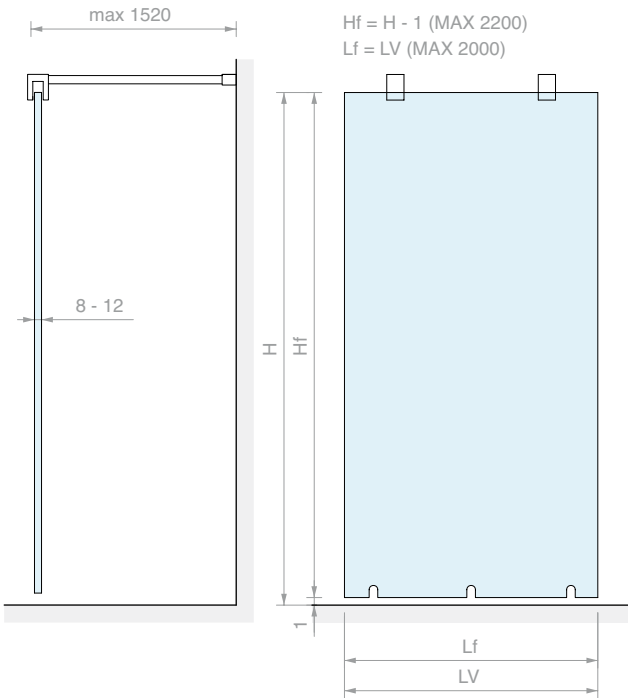
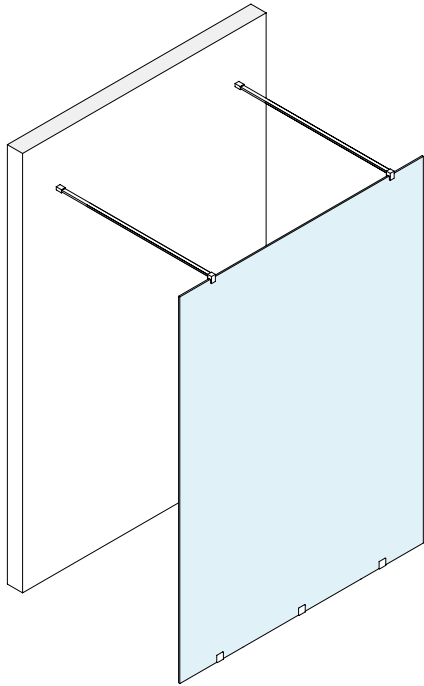

**DQM41**

**DQT1500**

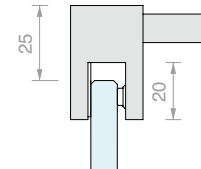
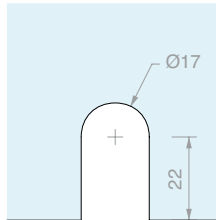

Kit comprising:

Art.	Description	Qty.
<b>DQM41</b>	Clamp flush to the wall	3 Pcs
<b>DQT1500</b>	Fixed stabilizer bar	2 Pcs

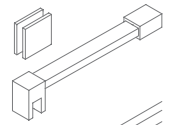

Optional

<b>PESQ0810B.150</b>	Water barrier profile	2 Pcs
----------------------	-----------------------	-------

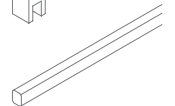

Art.	For glass	Qty
<b>OPEN03DQ</b>	From 8 to 12 mm	1 Pc



**TWO-SIDE WALK-IN  
SHOWER KIT WITH PROFILES**

Finish: /1 /2 /4 /24 /R2

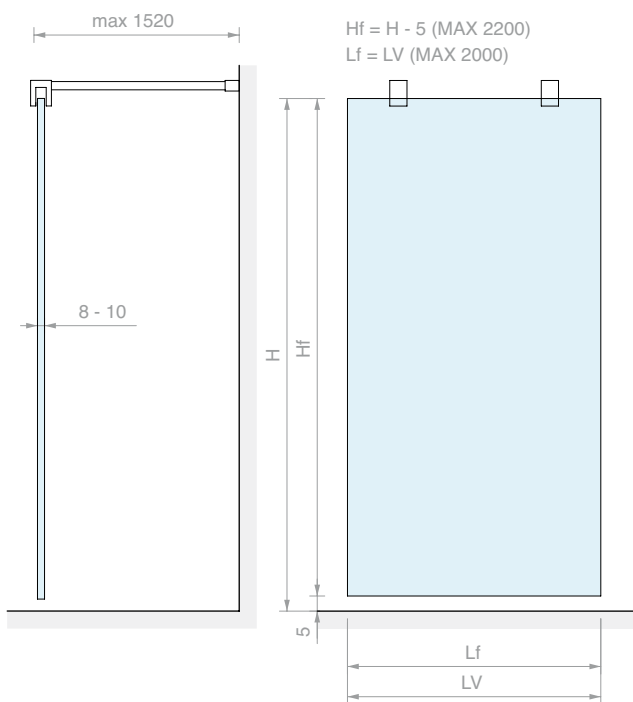
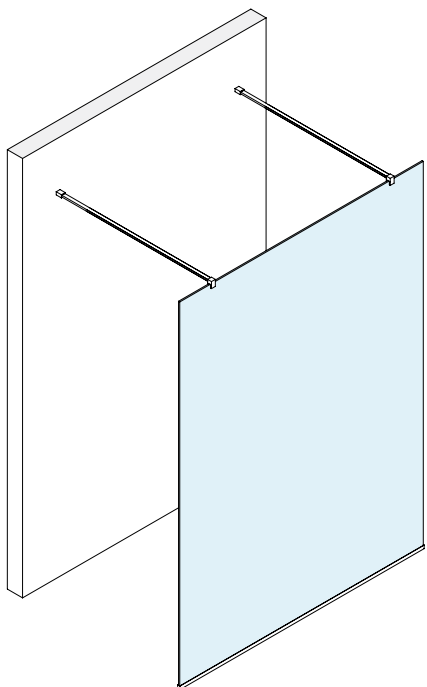

LMU20B.220

DQT1500

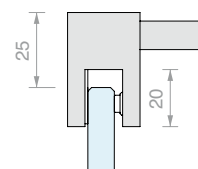
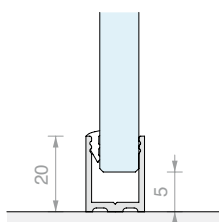

Kit comprising:

Art.	Description	Qty.
<b>LMU20B.220</b>	U-shaped profile	1 Pc
<b>LMU20TPB</b>	Flat cap	2 Pcs
<b>GTUP2</b>	Glass holder gasket	2 m
<b>GTUP4</b>	Glass holder gasket	2 m
<b>DQT1500</b>	Fixed stabilizer bar	2 Pcs
Optional		
<b>PESQ0810B.150</b>	Water barrier profile	2 Pcs

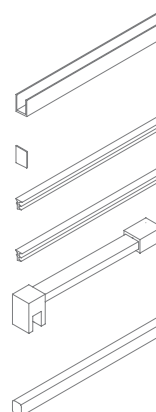

Art.	For glass	Qty
<b>OPEN03LMUDQ</b>	From 8 to 10 mm	1 Pc





**WALK-IN SHOWER KIT WITH CLAMPS**

Finish: /1 /2 /4 /24 /R2

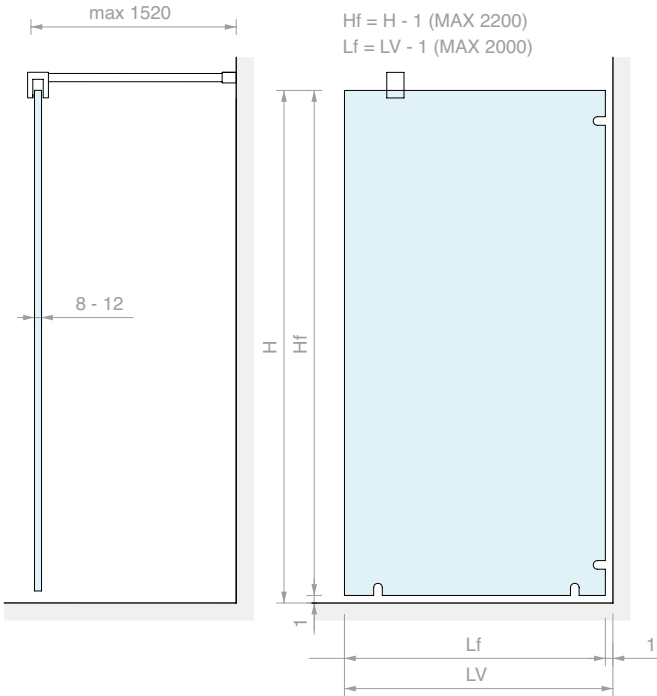
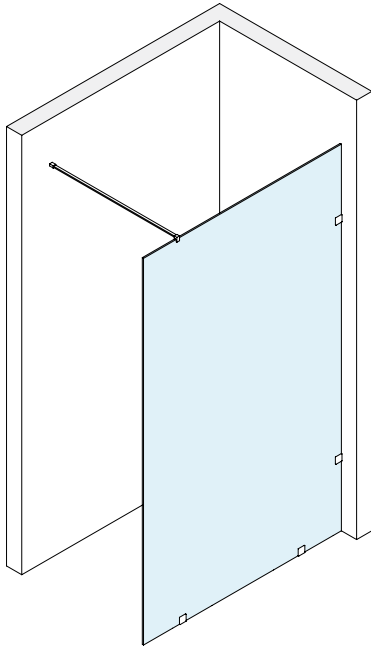

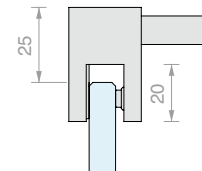
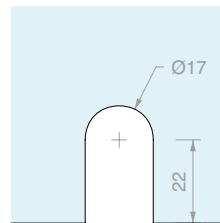

**DQM41**

**DQT1500**





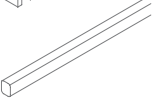

Kit comprising:

Art.	Description	Qty.	
<b>DQM41</b>	Clamp flush to the wall	4 Pcs	
<b>DQT1500</b>	Fixed stabilizer bar	1 Pc	
Optional			
<b>PESQ0810B.150</b>	Water barrier profile	1 Pc	

Art.	For glass	Qty
<b>OPEN01DQ</b>	From 8 to 12 mm	1 Pc



**WALK-IN SHOWER KIT WITH PROFILES**

Finish:     

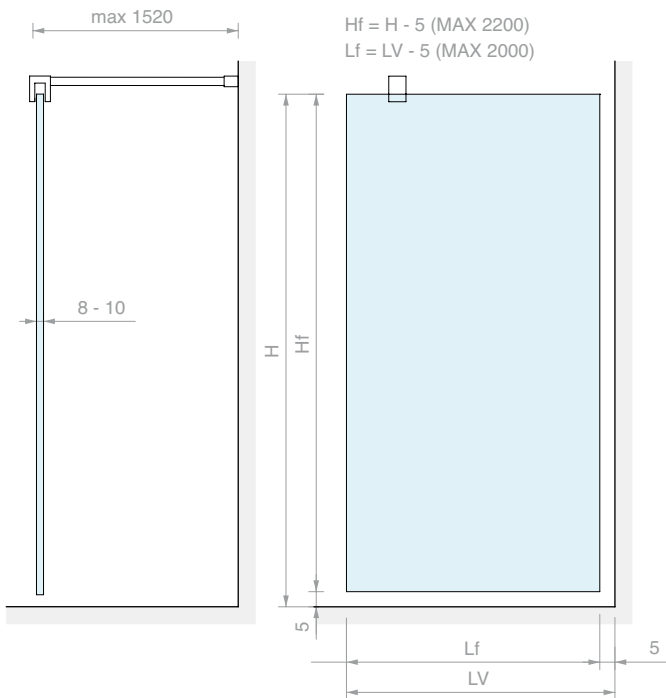
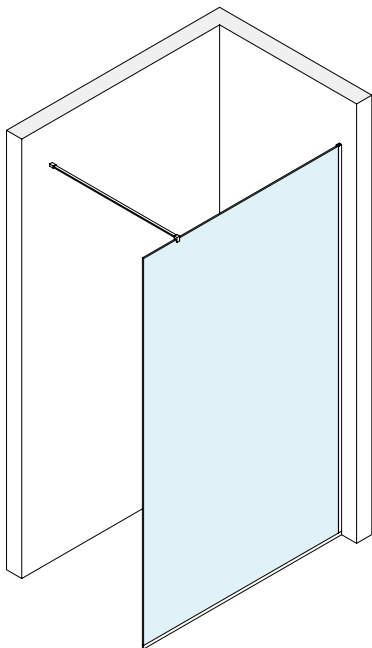

LMU20B.220

DQT1500

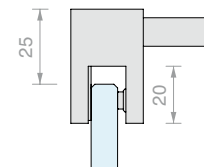
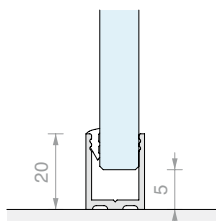

Kit comprising:

Art.	Description	Qty.
<b>LMU20B.220</b>	U-shaped profile	2 Pcs
<b>LMU20TPB</b>	Flat cap	1 Pc
<b>GTUP2</b>	Glass holder gasket	5 m
<b>GTUP4</b>	Glass holder gasket	5 m
<b>DQT1500</b>	Fixed stabilizer bar	1 Pc
Optional		
<b>PESQ0810B.150</b>	Water barrier profile	1 Pc

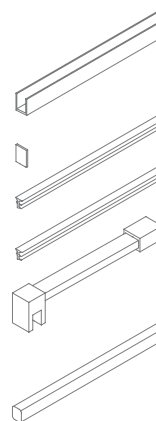

Art.	For glass	Qty
<b>OPEN01LMUDQ</b>	From 8 to 10 mm	1 Pc



WALK-IN SHOWER KIT WITH FINISHING PROFILES

Finish: 

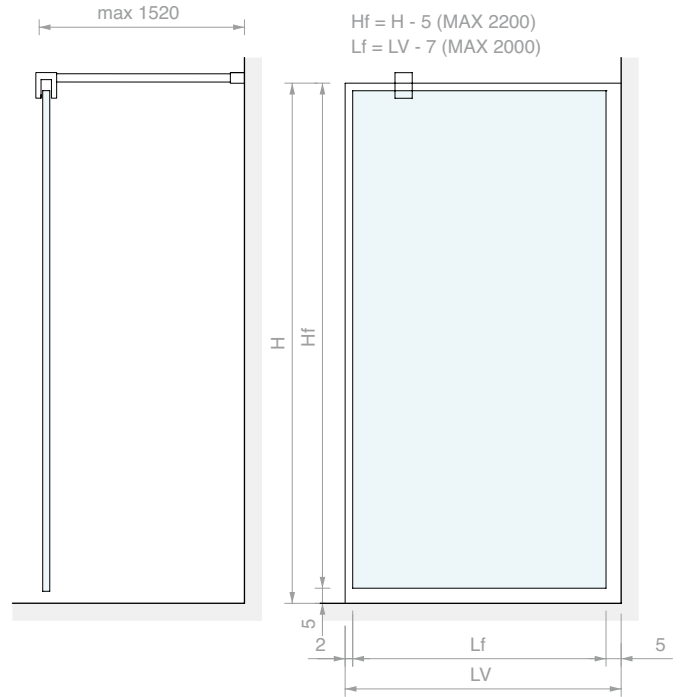
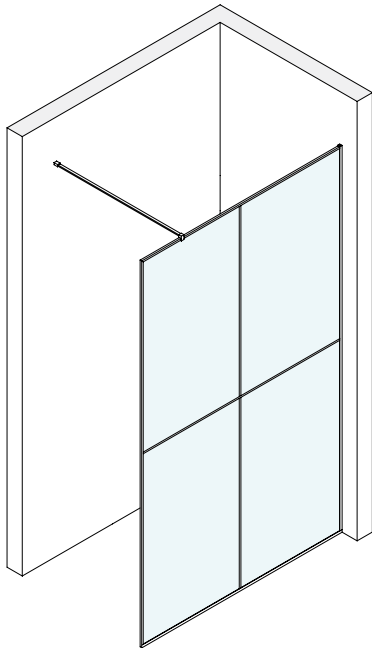

PBD3183.220

FOU1011.30

DQT1500

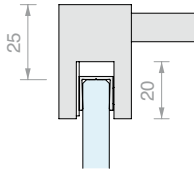
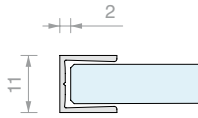
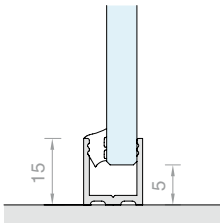







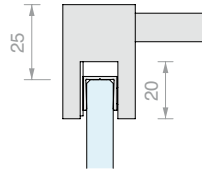
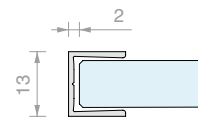
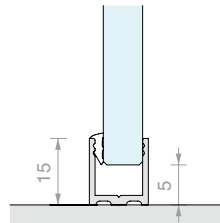

PBD3183.220

FOU1013.30









DQT1500



Kit comprising:

Art.	Description	Qty.	
<b>PBD3183.220</b>	U-shaped profile	2 Pcs	
<b>PBDTP</b>	Flat cap	1 Pc	
<b>GTUP4</b>	Glass holder gasket	5 m	
<b>FOU1011.30</b>	Flat U-shaped profile	2 Pcs	
<b>FOP10.30</b>	Flat profile	2 Pcs	
<b>DQT1500</b>	Fixed stabilizer bar	1 Pc	
Optional			
<b>PBD3183.150</b>	U-shaped profile	1 Pc	
<b>PBD3186.150</b>	Flat upper profile	1 Pc	

Kit comprising:

Art.	Description	Qty.	
<b>PBD3183.220</b>	U-shaped profile	2 Pcs	
<b>PBDTP</b>	Flat cap	1 Pc	
<b>GTUP2</b>	Glass holder gasket	5 m	
<b>FOU1013.30</b>	Flat U-shaped profile	2 Pcs	
<b>FOP10.30</b>	Flat profile	2 Pcs	
<b>DQT1500</b>	Fixed stabilizer bar	1 Pc	
Optional			
<b>PBD3183.150</b>	U-shaped profile	1 Pc	
<b>PBD3186.150</b>	Flat upper profile	1 Pc	

Art.	For glass	Qty
<b>OPEN01FOR8</b>	8 mm	1 Pc

Art.	For glass	Qty
<b>OPEN01FOR10</b>	10 mm	1 Pc



**WALK-IN SHOWER KIT WITH COLUMN**

Finish:  

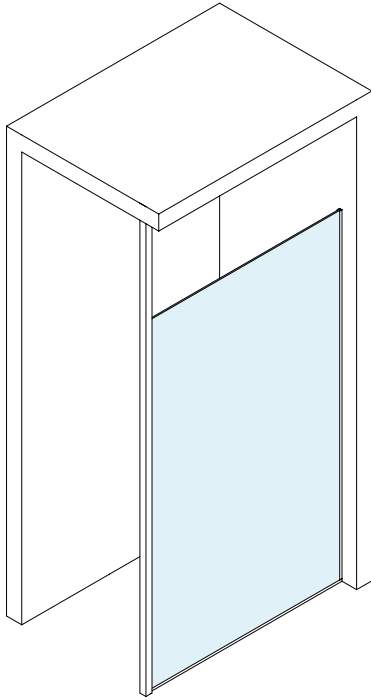

Hf = H - 5 (MAX 2200)  
Lf = LV - 35 (MAX 2000)

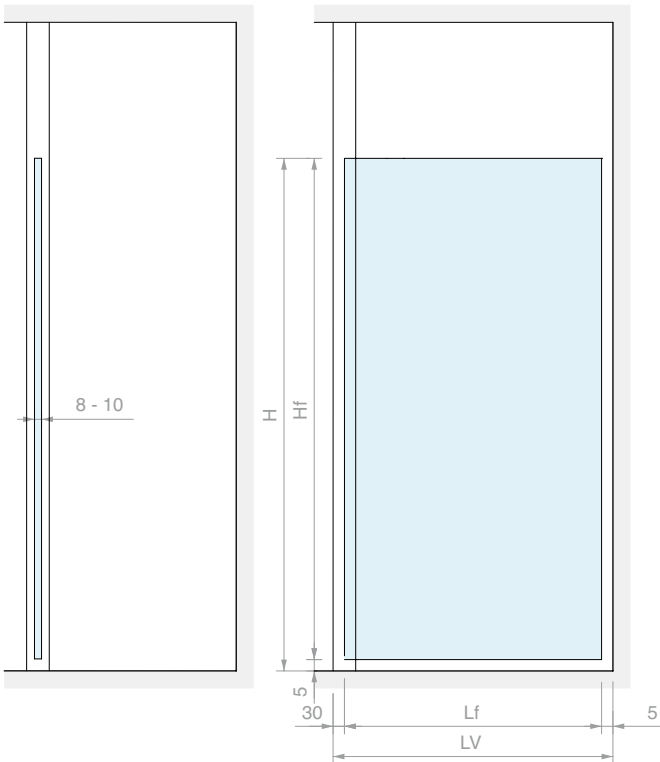

**PBD3183.220**

**NV3100**

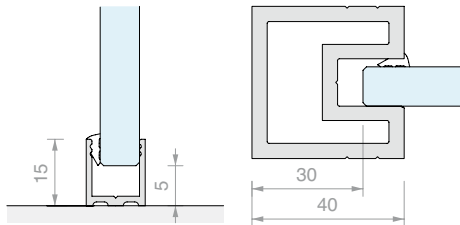

Kit comprising:

Art.	Description	Qty.
<b>NV3100</b>	Central column	1 Pc
<b>PBD3186.150</b>	Flat upper profile	1 Pc
<b>NV3500</b>	Upper cover for column	1 Pc
<b>NV3200</b>	Central fixing kit	1 Pc
<b>PBD3183.220</b>	U-shaped profile	2 Pcs
<b>GTUP2</b>	Glass holder gasket	5 m
<b>GTUP4</b>	Glass holder gasket	5 m
Optional		
<b>PBD3183.150</b>	U-shaped profile	1 Pc
<b>PBD3186.150</b>	Flat upper profile	1 Pc

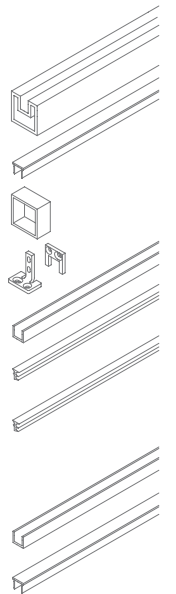

Art.	For glass	Qty
<b>OPEN01NOVI</b>	From 8 to 10 mm	1 Pc





# TABLE OF SQUARE SERIES ACCESSORIES



## Hinges

for glass thickness from 6 to 8 mm

								
DQ30COV	DQ30	DQ32	DQ34	DQ380	DQ390	DQ3135	DQ37	DQ375
Page 202	Page 203	Page 204	Page 205	Page 206	Page 207	Page 208	Page 209	Page 210

## Locks

for glass thickness from 6 to 8 mm

				
DQC35	DQC37	DQC38	DQC39	DQC395
Page 212	Page 212	Page 212	Page 213	Page 213









## Hinges

for glass thickness from 8 to 12 mm

										
DQ40COV	DQ40	DQ42	DQ44	DQ44P	DQ480	DQ480P	DQ490	DQ4135	DQ475	DQ497
Page 214	Page 215	Page 216	Page 217	Page 218	Page 219	Page 220	Page 221	Page 222	Page 223	Page 224

## Locks











for glass thickness from 8 to 10 mm

								
DQC51	DQC53	DQC55	DQC575	DQC58	DQC59	DQC61	DQC63	DQC65
Page 226	Page 226	Page 226	Page 227	Page 227	Page 227	Page 228	Page 228	Page 228



## Clamps

												
DQM41	DQM43	DQM57	DQM52	DQM50	DQM54	DQM47	DQM45	DQM49	DQM09	DQM11	DQM07	DQMP
Page 229	Page 229	Page 229	Page 229	Page 230	Page 230	Page 230	Page 230	Page 231	Page 231	Page 231	Page 231	Page 235



## Stabilizer bars

										
DQT	DQX	DQA500	DQA55	DQA	DQA85	DQA86	DQA8670	DQA90	DQA93	DQA88
Page 232	Page 232	Page 233	Page 233	Page 234	Page 234	Page 234	Page 234	Page 235	Page 235	Page 235













## Knobs

		
DQTS2525	DQP2525	POM2525
Page 236	Page 236	Page 236







## Towel racks and hooks

		
DQP365	DQP375	DQP385
Page 237	Page 237	Page 236

## Profiles for fixed panes and caps

											
NOVI3000	PBD3183	PBD3184	PBD3186	PBDTP	FOP	FOL	FOU	LMU20B	LMU86B	LMU20TPB	PESQB
Page 240	Page 242	Page 242	Page 242	Page 242	Page 243	Page 243	Page 243	Page 238	Page 238	Page 238	Page 238

## Gaskets

						
From 6 to 8 mm	GM62	GM12SX	GM12DX	GM58	GM60	GTUP
	Page 244	Page 244	Page 244	Page 244	Page 244	Page 245
From 8 to 10 mm	GM06	GM1520SX	GM1520DX	GM54	GM02	GM0422
	Page 244	Page 245	Page 245	Page 245	Page 245	Page 245



**WALL/GLASS ADJUSTABLE  
SIDE HINGE**

Material: Brass

Finish: /1 /2 /4 /24 /R2

Spare plate DQMP7 on p. 235

6/8

MAX 850

40

CLOSING RETURN

±10° ADJUSTMENT

±90° ROTATION

NO VISIBLE SCREWS

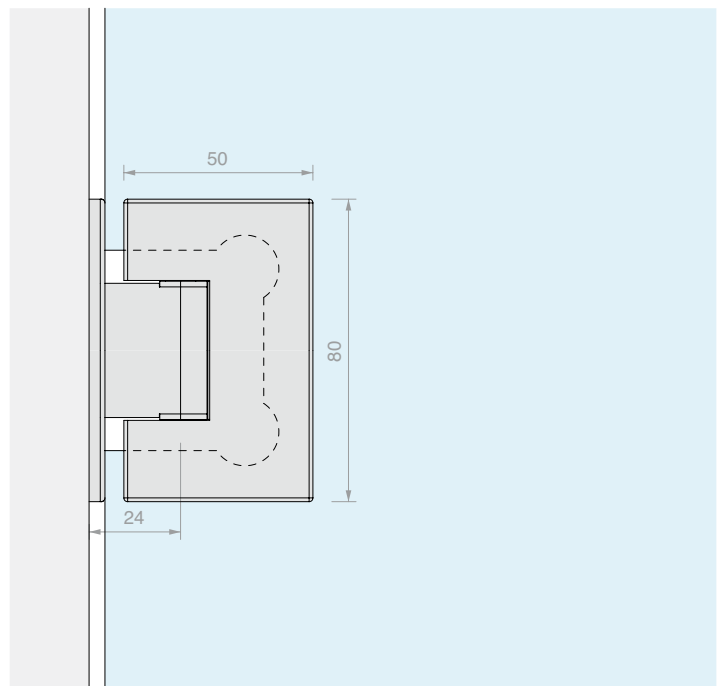
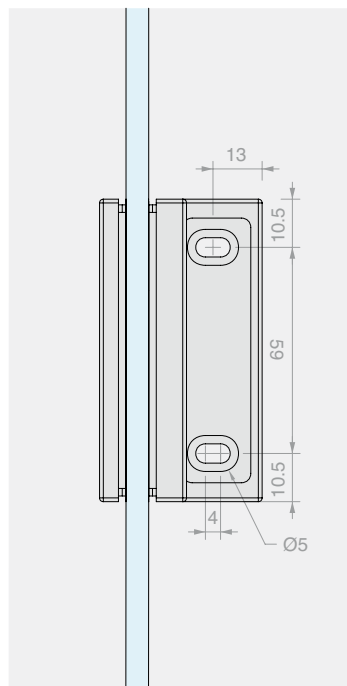
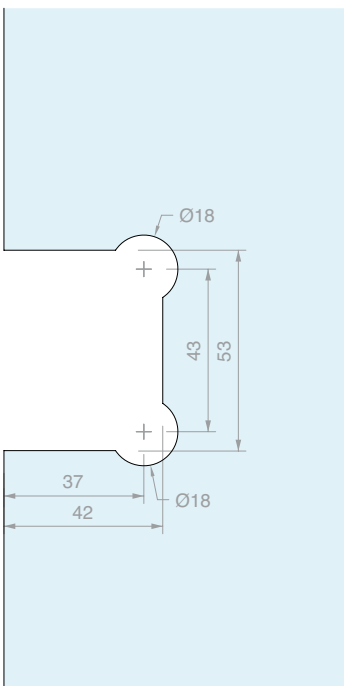
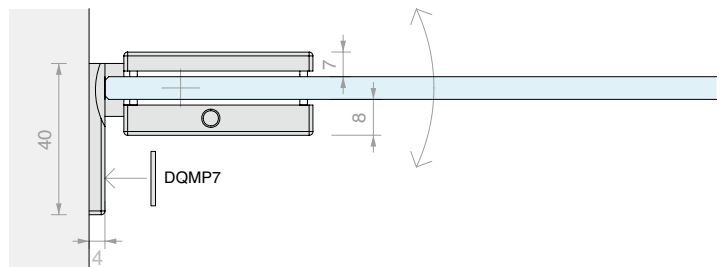

Art.  
**DQ30COV**

For glass  
From 6 to 8 mm

Qty  
1 Pc



**WALL/GLASS ADJUSTABLE  
SIDE HINGE**

Material: Brass

Finish: /1 /24 /R2

Provided with adhesive screw covers

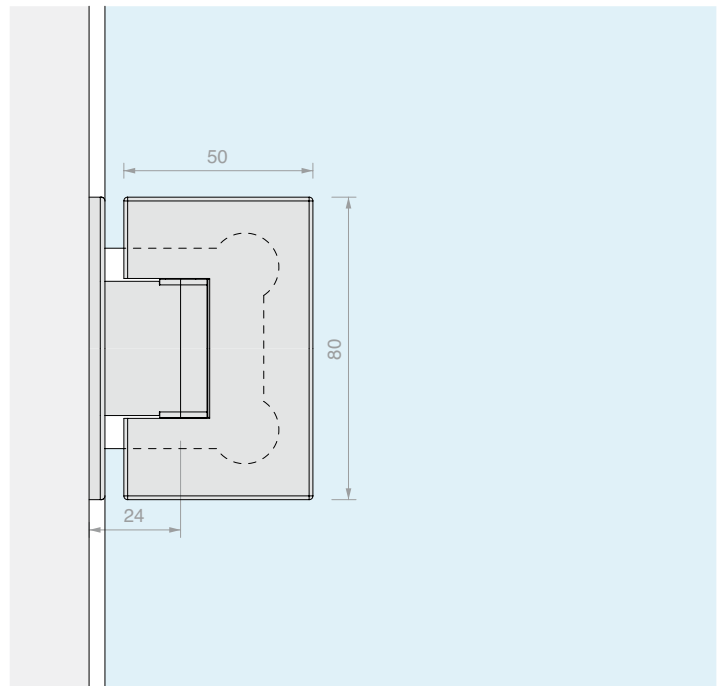
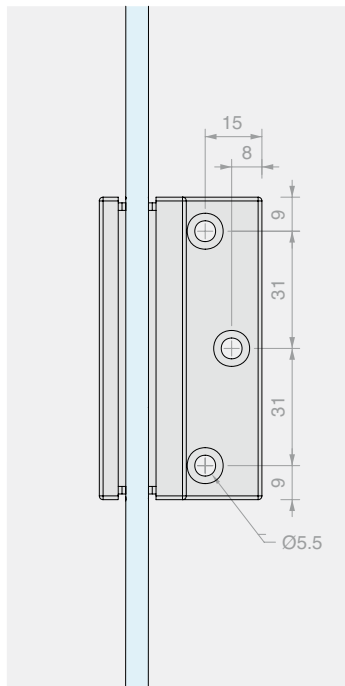
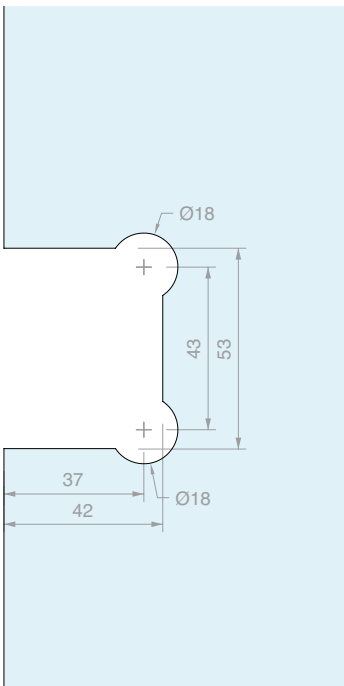
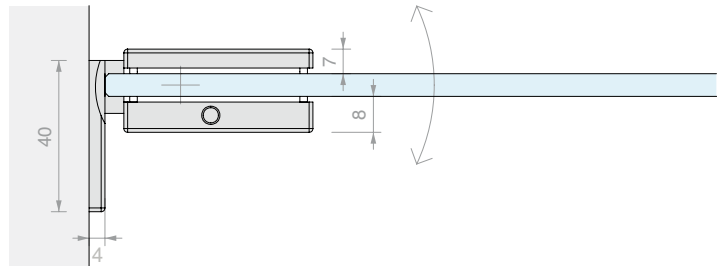
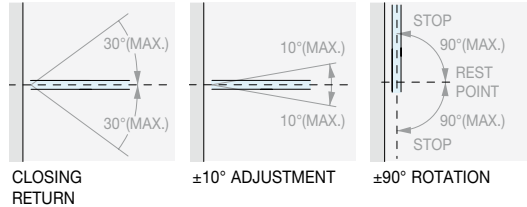
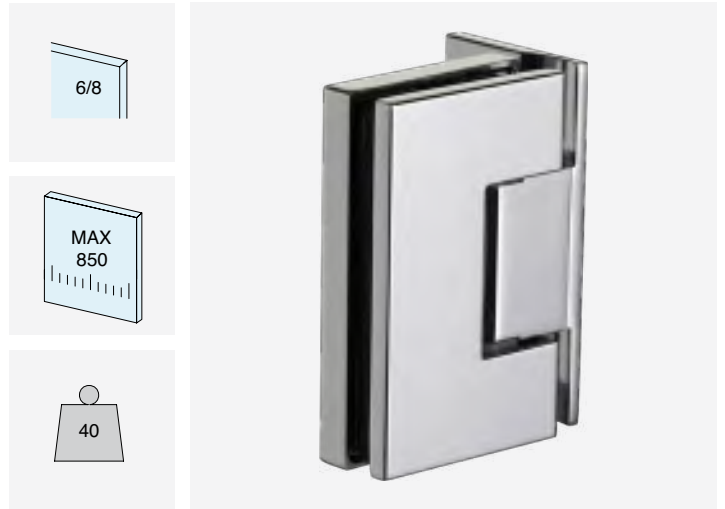

Art.	For glass	Qty
<b>DQ30</b>	From 6 to 8 mm	1 Pc



**WALL/GLASS ADJUSTABLE  
CENTRAL HINGE**

Material: Brass

Finish: /1 /24 /R2

Provided with adhesive screw covers

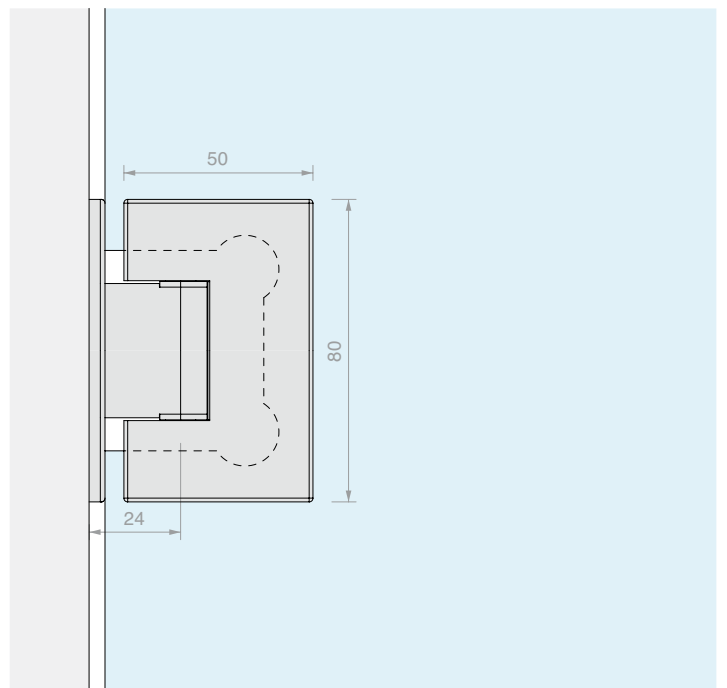
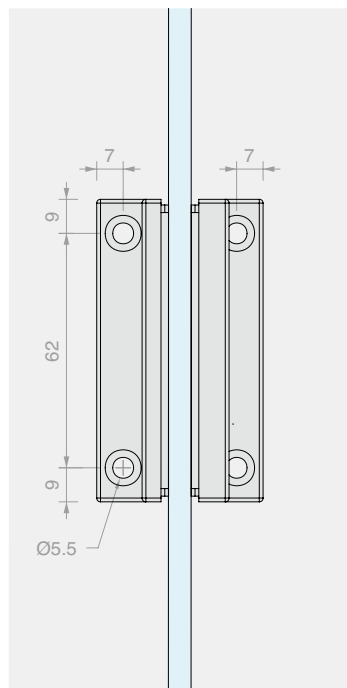
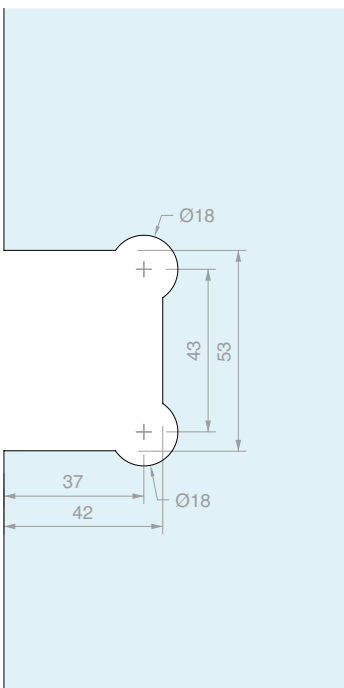
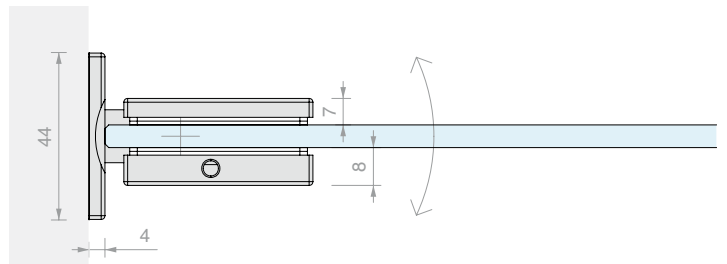
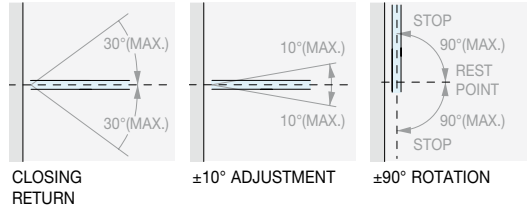
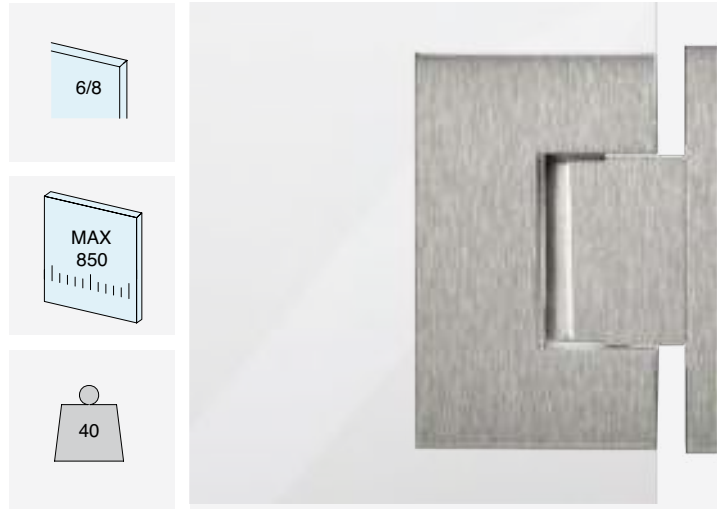

Art.	For glass	Qty
<b>DQ32</b>	From 6 to 8 mm	1 Pc



**WALL/GLASS ADJUSTABLE HINGE FOR NARROW JAMBS**

Material: Brass

Finish: /1 /2 /24 /R2

Spare plate DQMP9 on p. 235

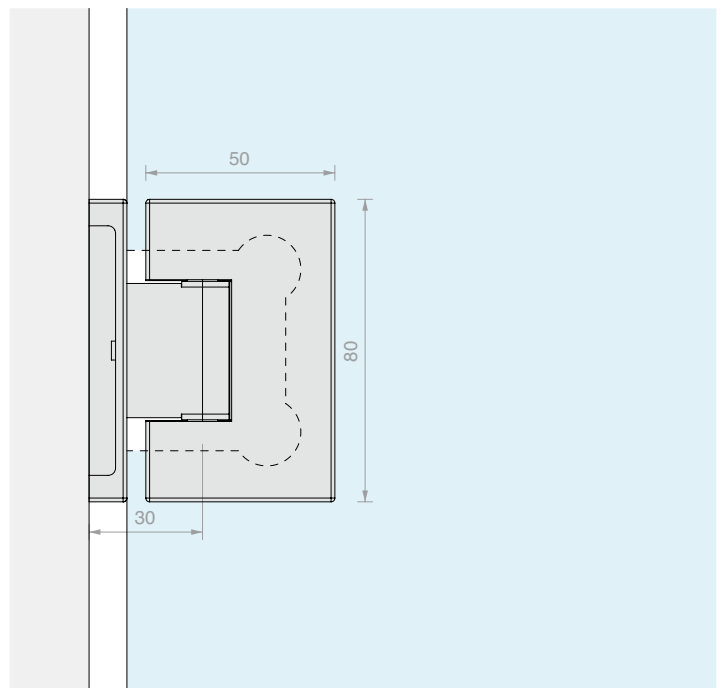
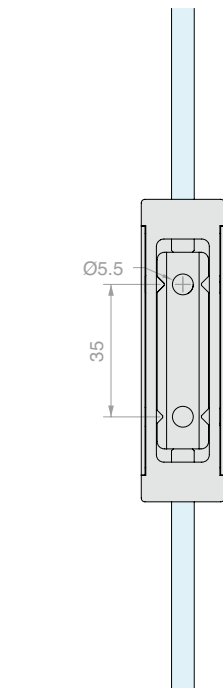
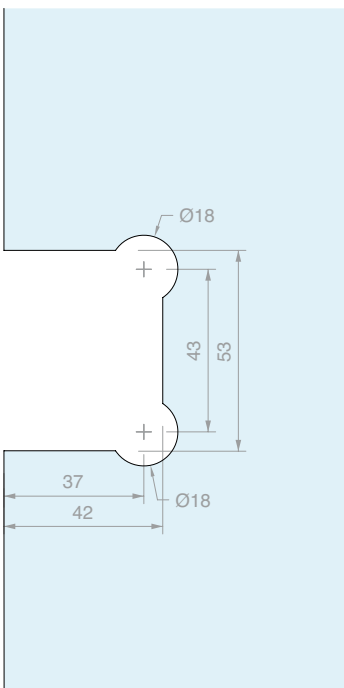
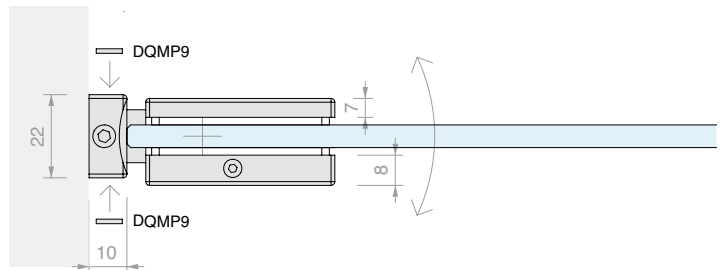
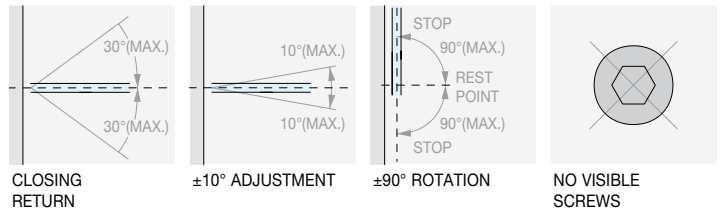
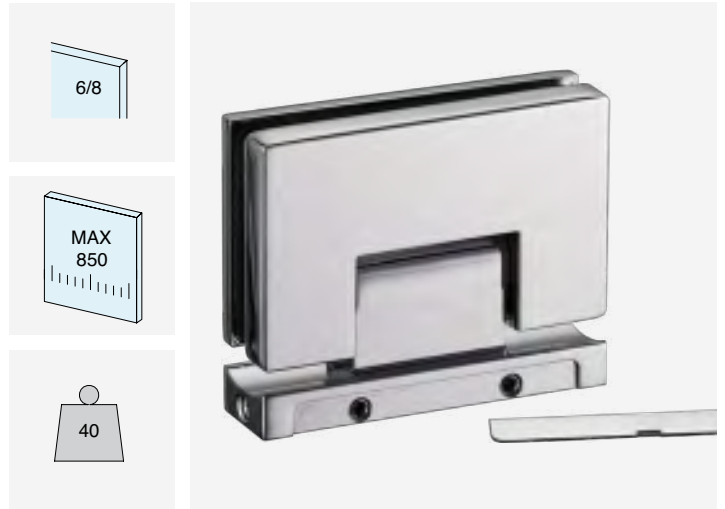

Art. **DQ34** For glass From 6 to 8 mm

Qty 1 Pc



### GLASS/GLASS ADJUSTABLE IN-LINE HINGE

Material: Brass

Finish: /1 /2 /4 /24 /R2

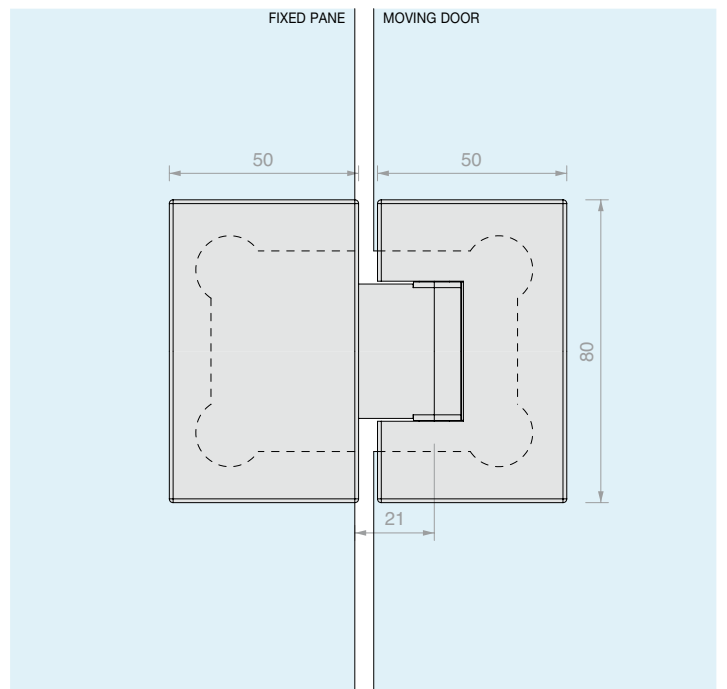
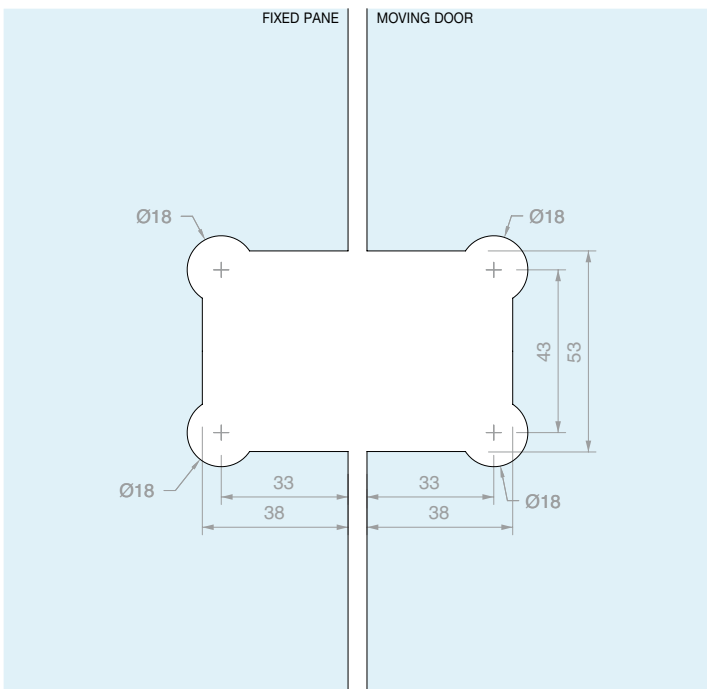
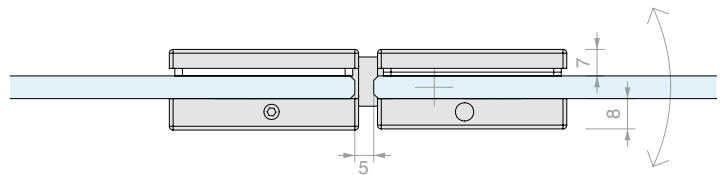
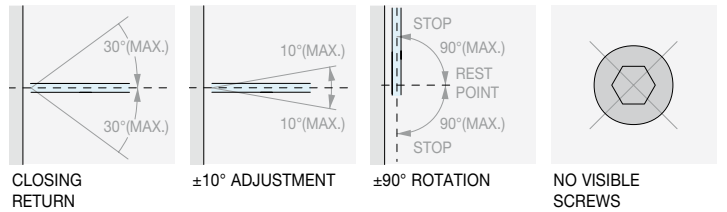
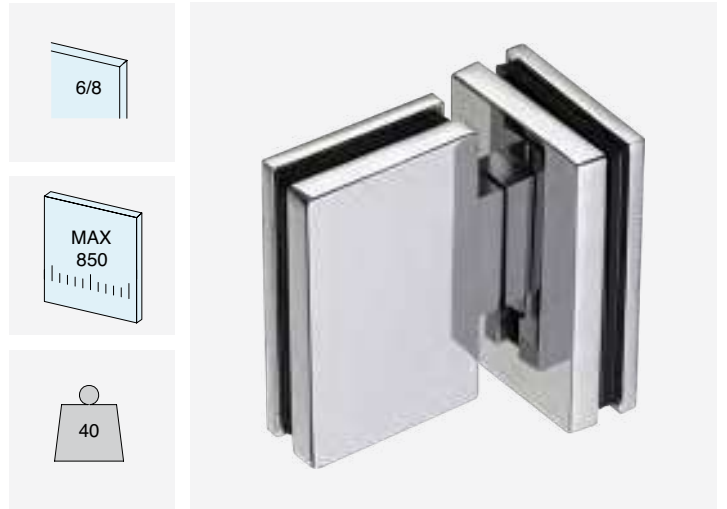

Art. **DQ380** For glass From 6 to 8 mm

Qty 1 Pc



**GLASS/GLASS 90°  
ADJUSTABLE HINGE**

Material: Brass  
Finish: /1 /24 /R2

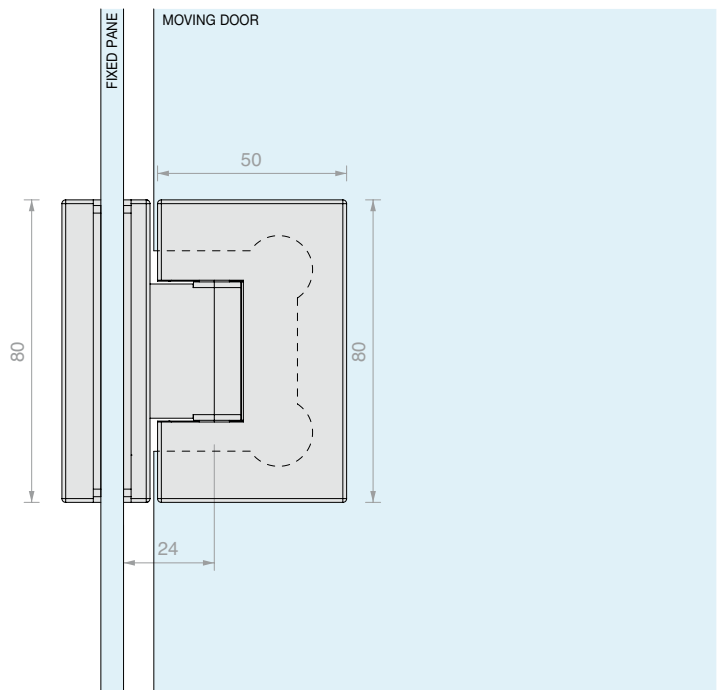
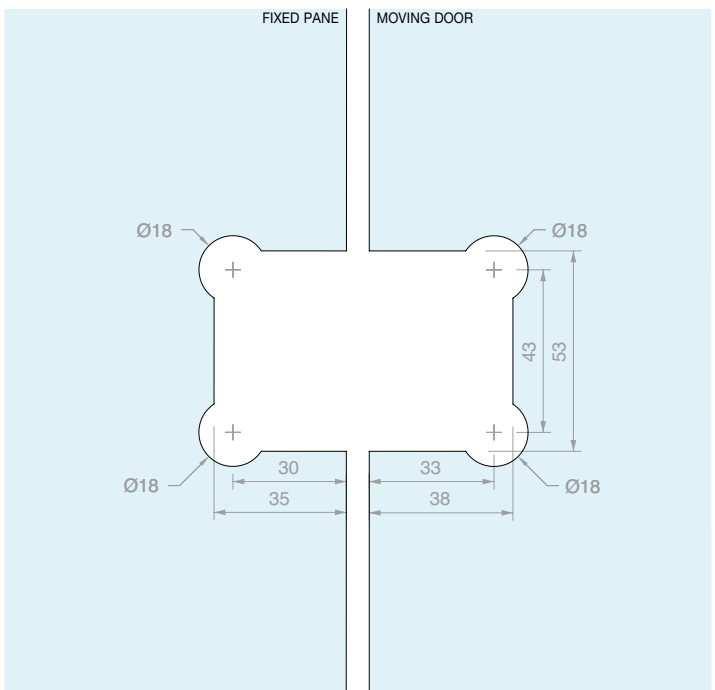
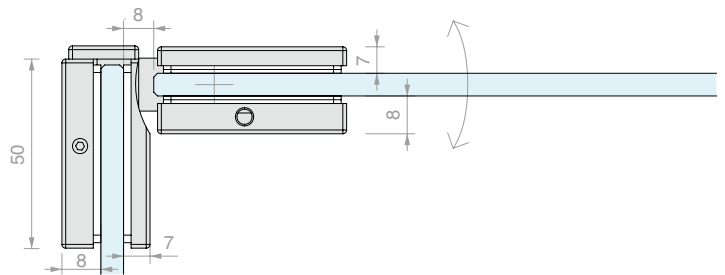
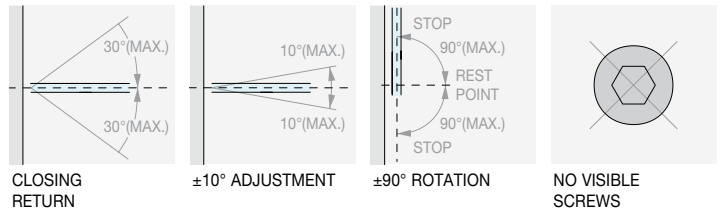

Art. <b>DQ390</b>	For glass From 6 to 8 mm	Qty 1 Pc
----------------------	-----------------------------	-------------



**GLASS/GLASS 135°  
ADJUSTABLE HINGE**

Material: Brass  
Finish: /1 /24 /R2

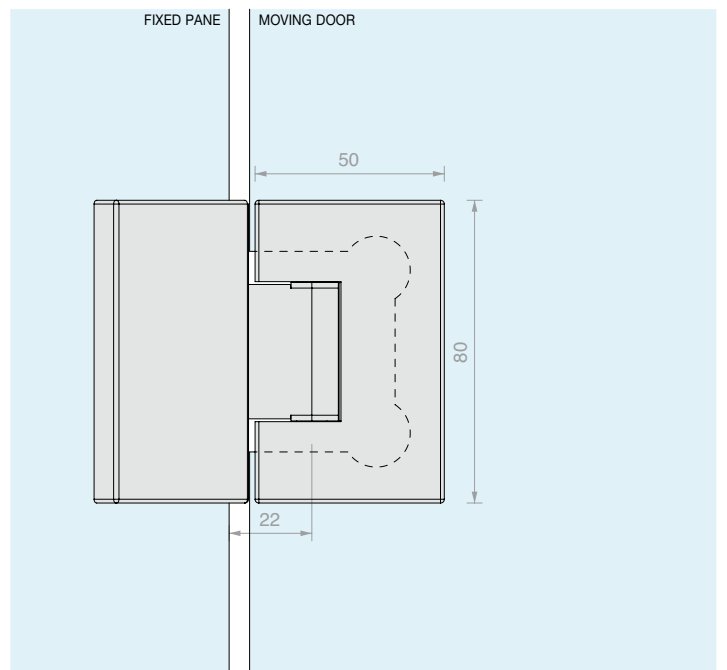
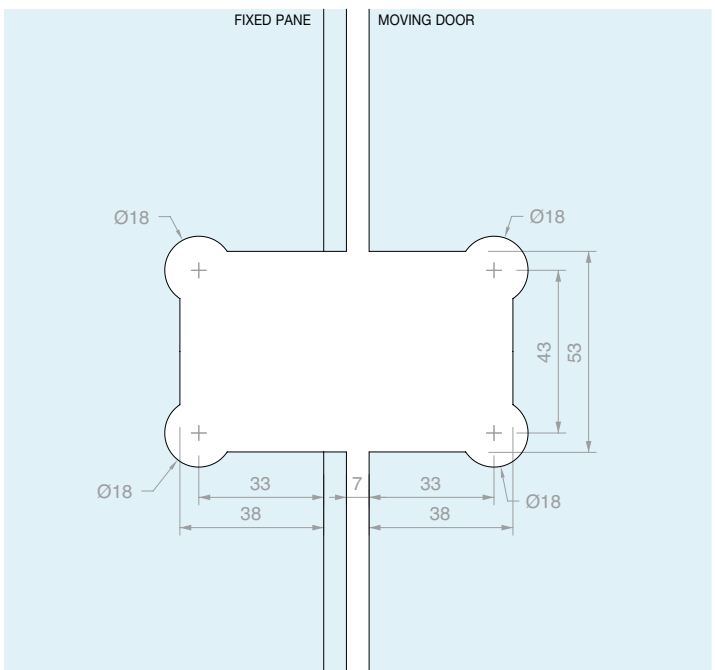
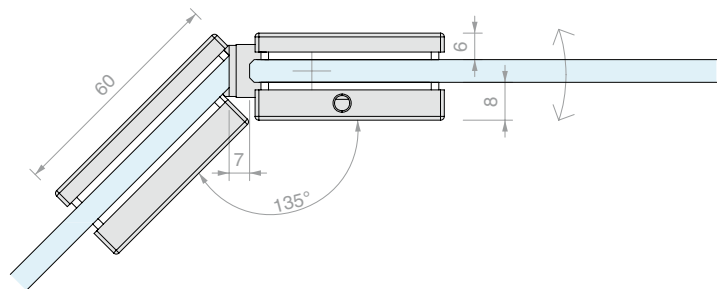
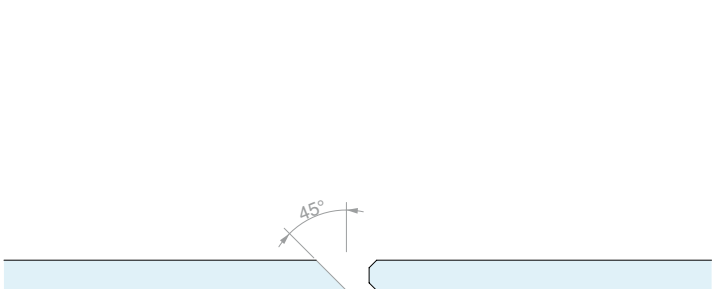

Art. **DQ3135** For glass From 6 to 8 mm

Qty 1 Pc





**WALL/GLASS ADJUSTABLE  
IN-LINE HINGE**

Material: Brass  
Finish: /1 /24  
Spare plate DQMP6 on p. 235





6/8



MAX  
850



40





CLOSING  
RETURN



±10° ADJUSTMENT



±90° ROTATION



NO VISIBLE  
SCREWS

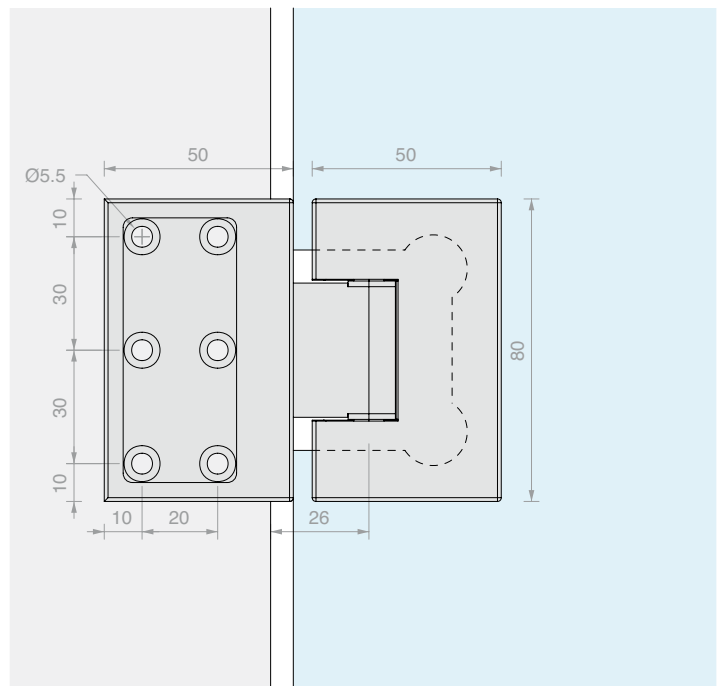
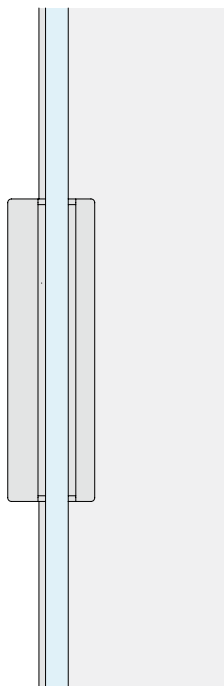
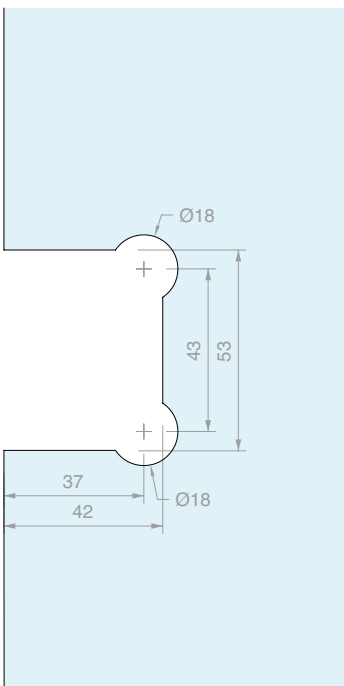
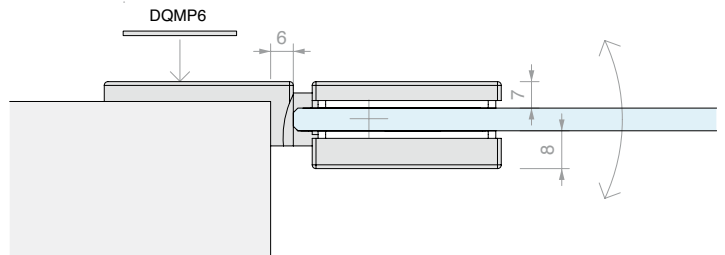

Art. <b>DQ37</b>	For glass From 6 to 8 mm	Qty 1 Pc
---------------------	-----------------------------	-------------



**WALL/GLASS 135°  
ADJUSTABLE HINGE**

Material: Brass  
Finish: /1 /24  
Spare plate DQMP6 on p. 235

6/8

MAX 850

40

CLOSING RETURN

±10° ADJUSTMENT

±90° ROTATION

NO VISIBLE SCREWS

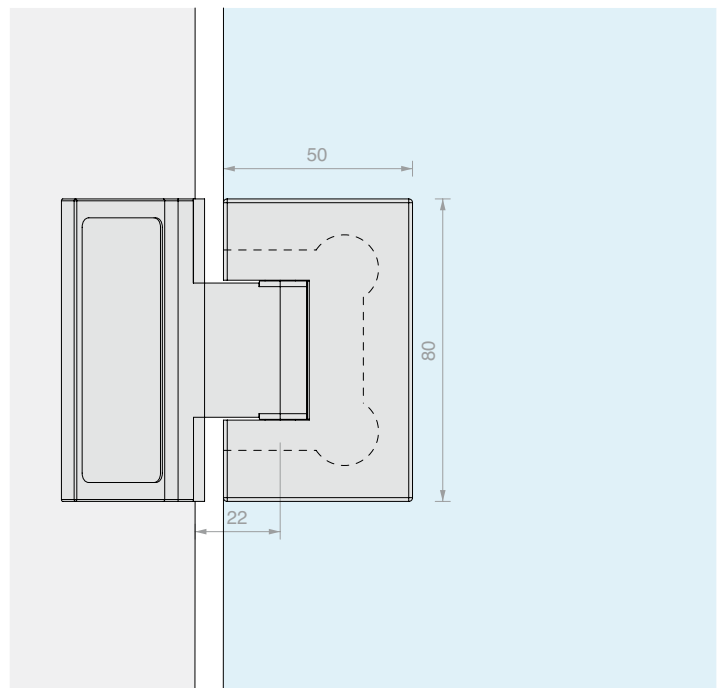
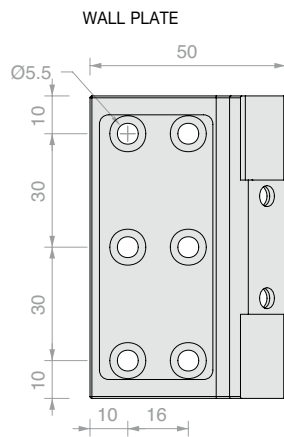
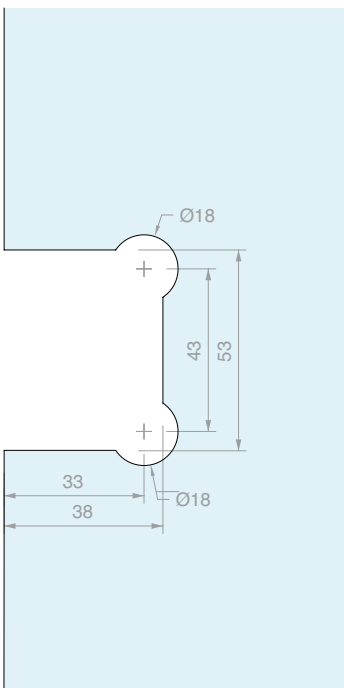
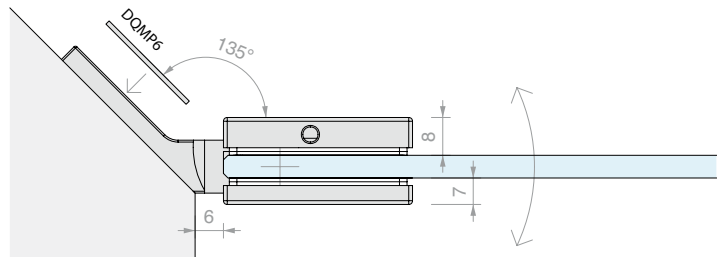

Art.	For glass	Qty
<b>DQ375</b>	From 6 to 8 mm	1 Pc





**LOCK WITH DOUBLE DOOR KNOB**

Material: Brass

Finish: /1 /2 /4 /24 /R2

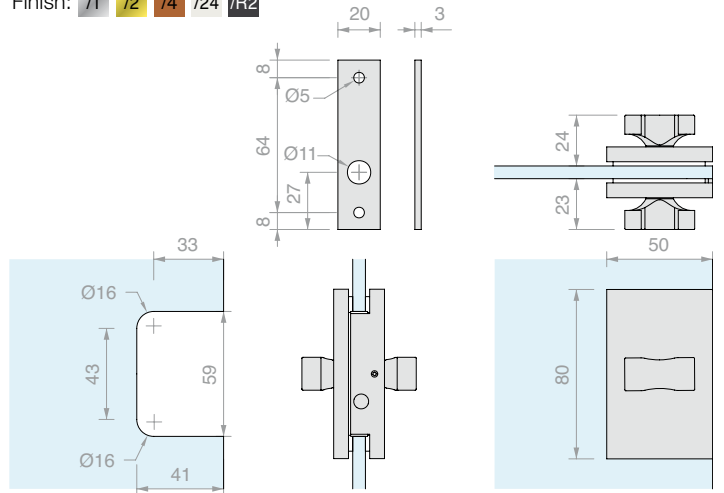

Art.	Pin	For glass	Qty
<b>DQC35</b>	Ø7 L 15 mm	From 6 to 8 mm	1 Pc



**LOCK WITH DOUBLE DOOR KNOB AND HANDLES**

Material: Brass

Finish: /1 /24

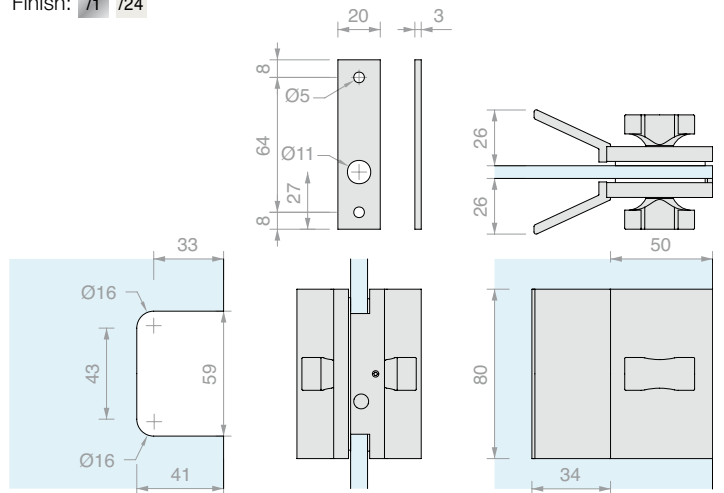

Art.	Pin	For glass	Qty
<b>DQC37</b>	Ø7 L 15 mm	From 6 to 8 mm	1 Pc



**FREE/OCCUPIED LOCK WITH DOOR KNOB**

Material: Brass

Finish: /1 /24

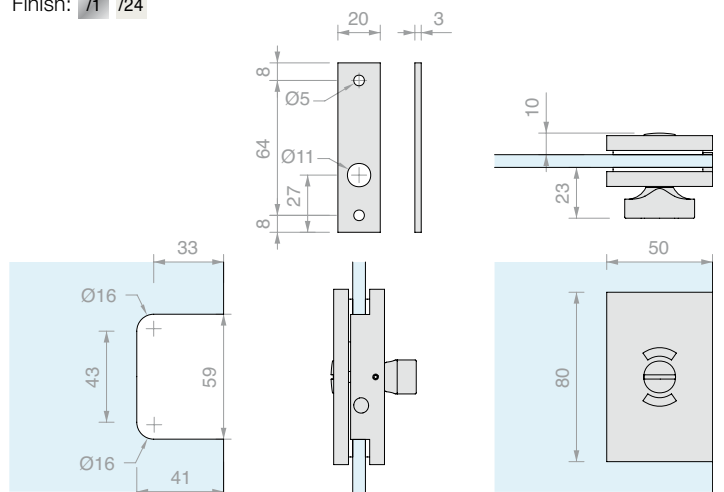

Art.	Pin	For glass	Qty
<b>DQC38</b>	Ø7 L 15 mm	From 6 to 8 mm	1 Pc



**FREE/OCCUPIED LOCK WITH DOOR KNOB AND HANDLES**

Material: Brass

Finish: /1 /24

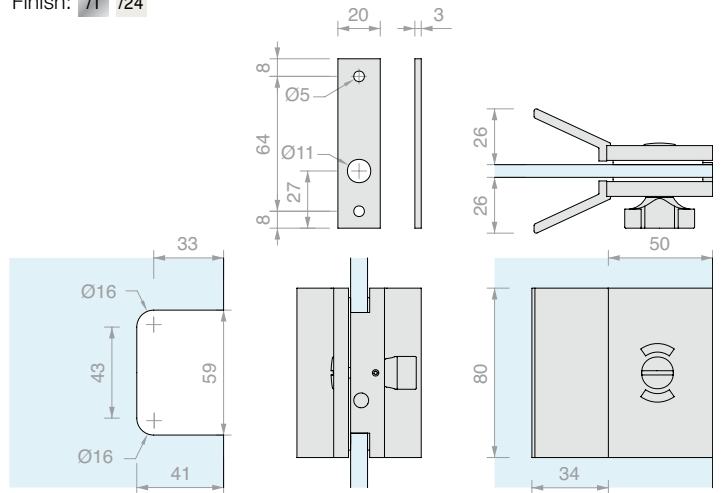

Art.	Pin	For glass	Qty
<b>DQC39</b>	Ø7 L 15 mm	From 6 to 8 mm	1 Pc



**STRIKE PLATE FOR GLASS**

Material: Brass

Finish: /1 /2 /4 /24 /R2

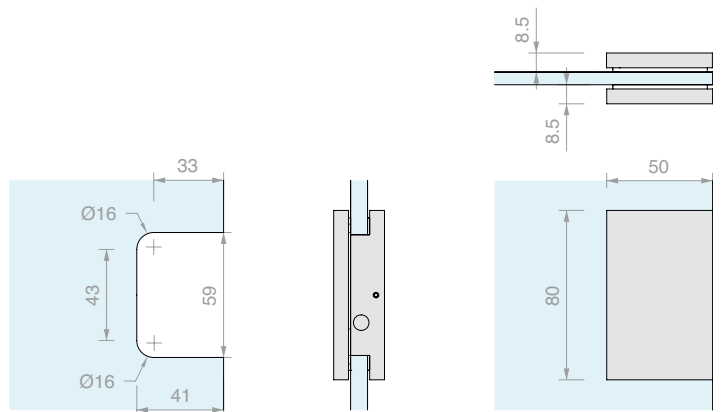

Art.	For glass	Qty
<b>DQC395</b>	From 6 to 8 mm	1 Pc







**WALL/GLASS ADJUSTABLE  
SIDE HINGE**

Material: Brass

Finish: /1 /2 /4 /24 /R2

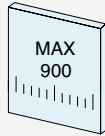
Spare plate DQMP8 on p. 235





CLOSING RETURN

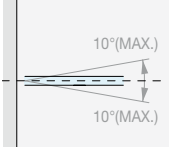

±10° ADJUSTMENT



±90° ROTATION



NO VISIBLE SCREWS

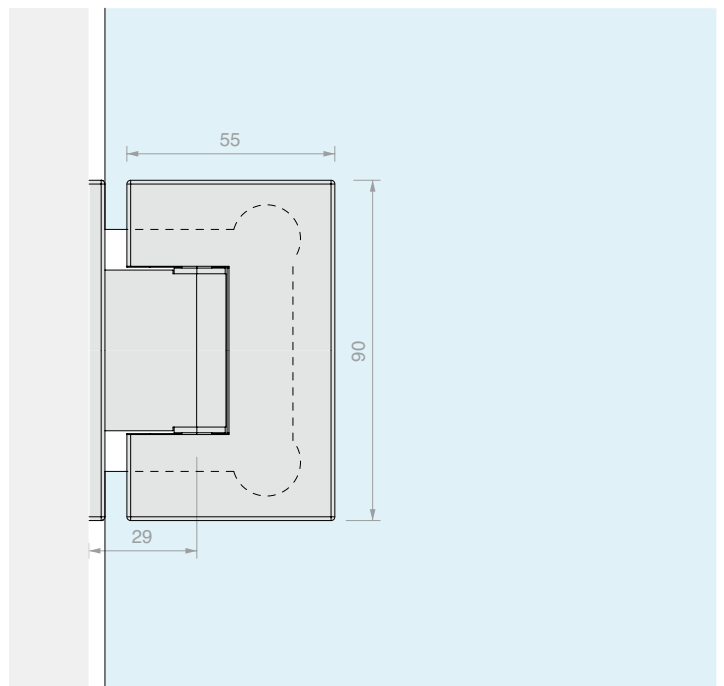
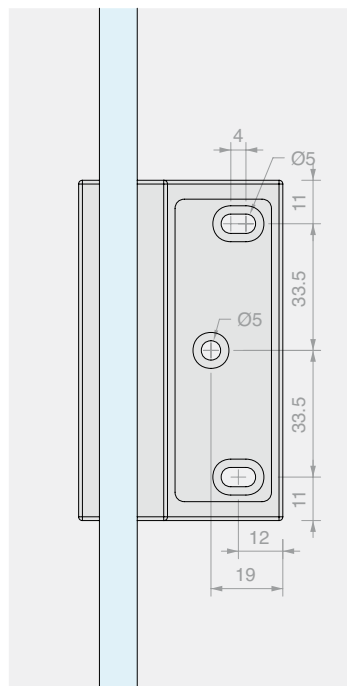
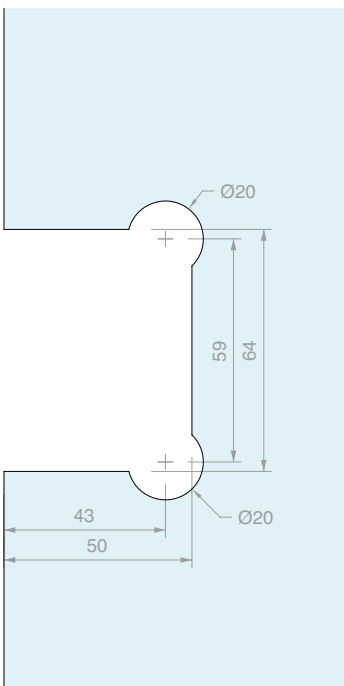
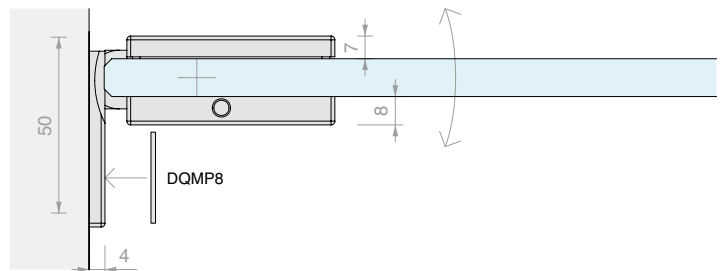

Art. **DQ40COV**

For glass  
From 8 to 12 mm

Qty  
1 Pc



**WALL/GLASS ADJUSTABLE  
SIDE HINGE**

Material: Brass

Finish: /1 /24 /R2

Provided with adhesive screw covers

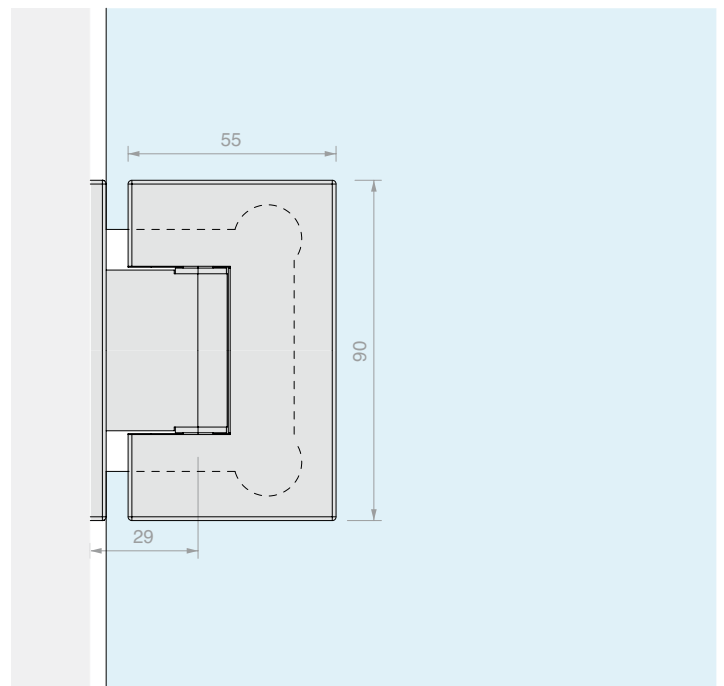
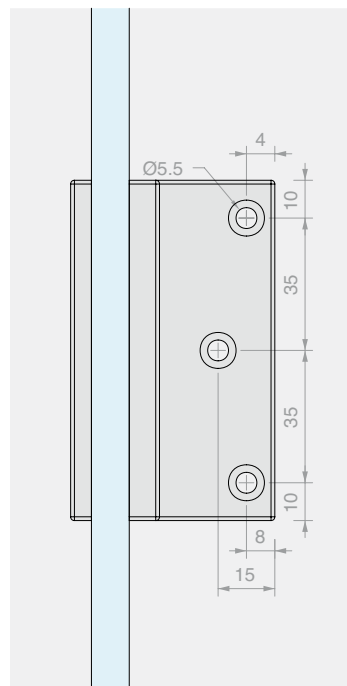
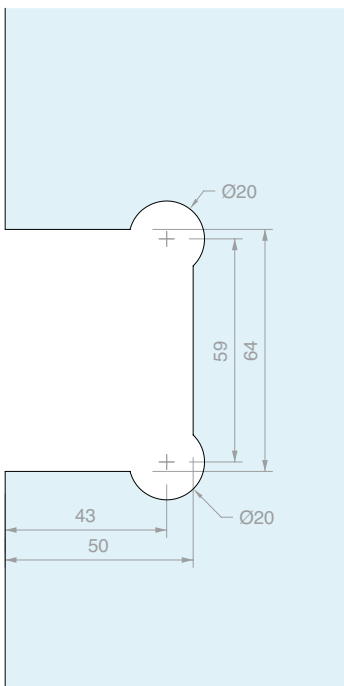
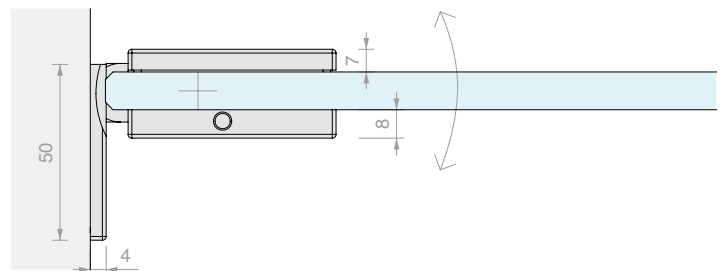
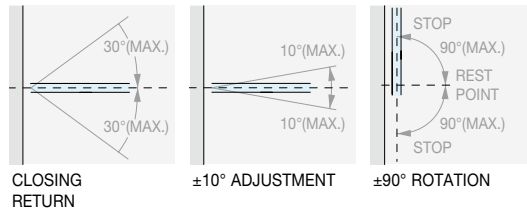
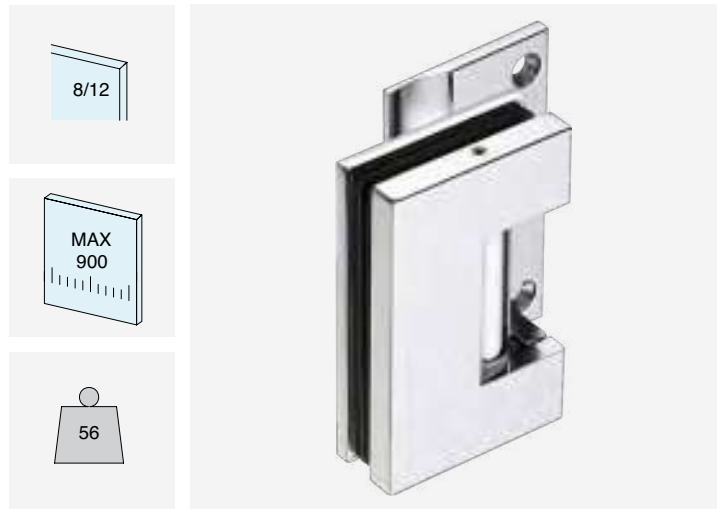

Art.  
**DQ40**

For glass  
From 8 to 12 mm

Qty  
1 Pc



### WALL/GLASS ADJUSTABLE CENTRAL HINGE

Material: Brass

Finish: /1 /24 /R2

Provided with adhesive screw covers

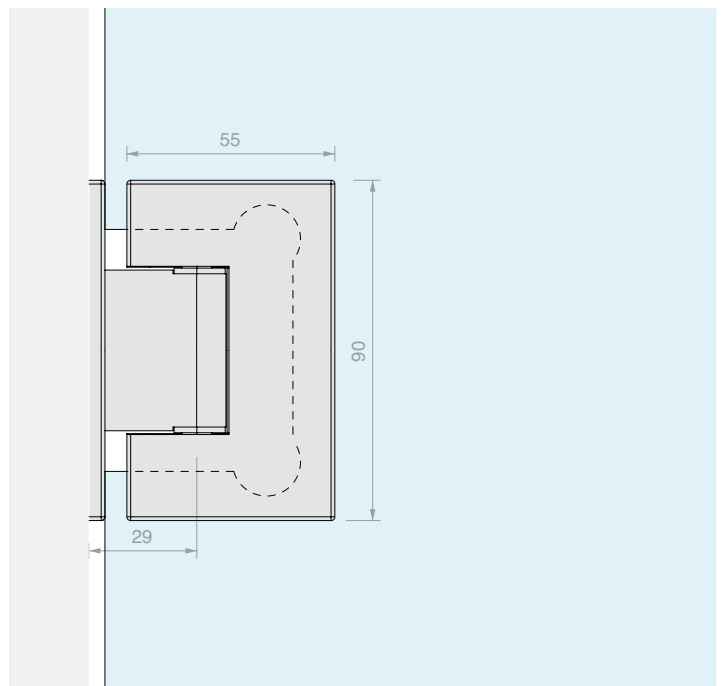
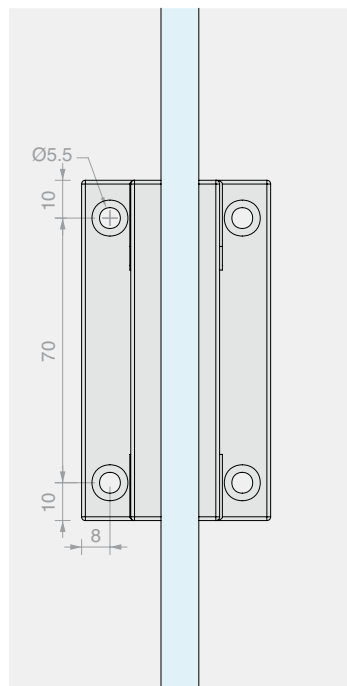
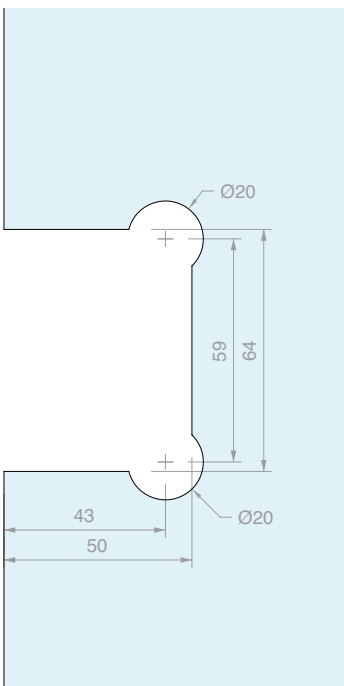
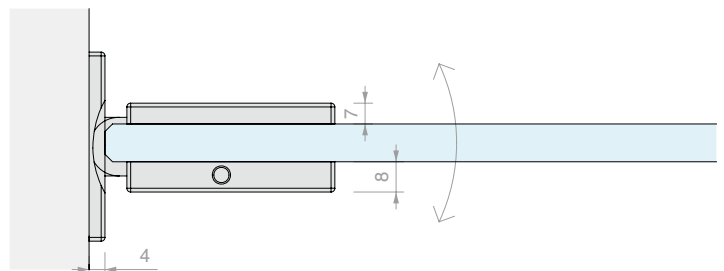
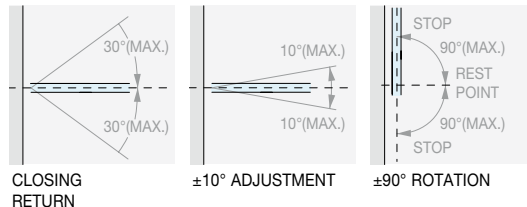
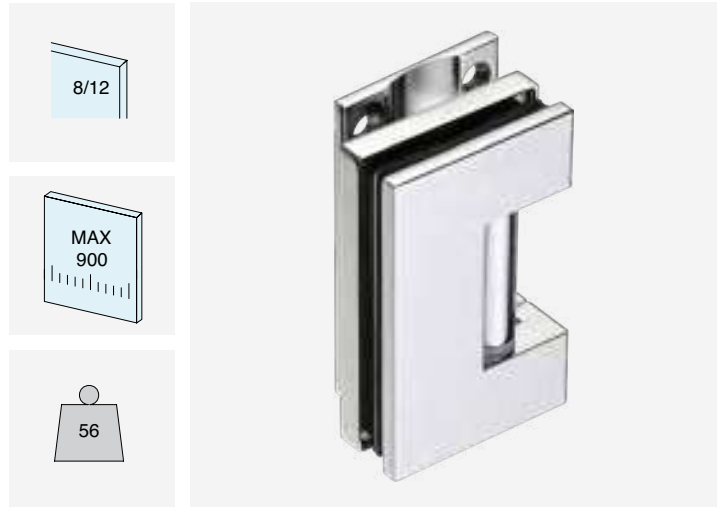

Art.	For glass	Qty
<b>DQ42</b>	From 8 to 12 mm	1 Pc





**WALL/GLASS ADJUSTABLE HINGE FOR NARROW JAMBS**

Material: Brass

Finish: /1 /2 /24 /R2

Spare plate DQMP9 on p. 235

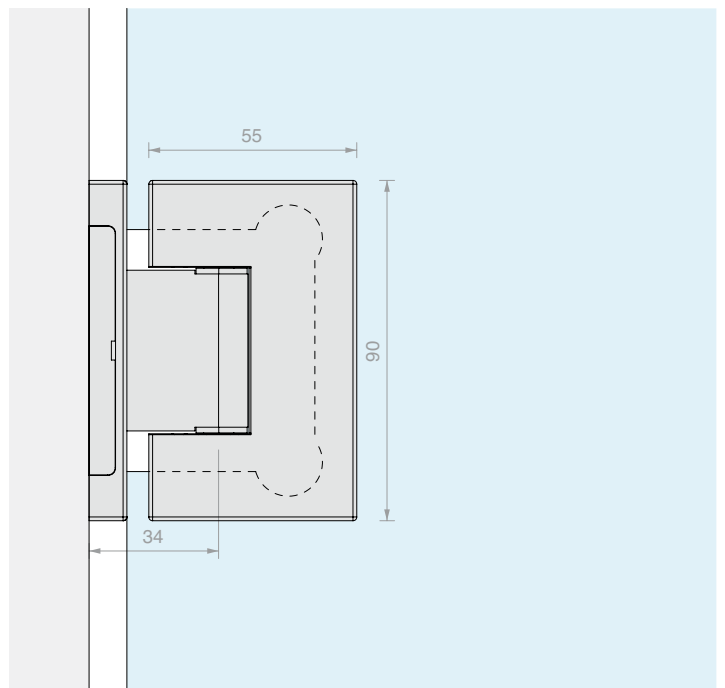
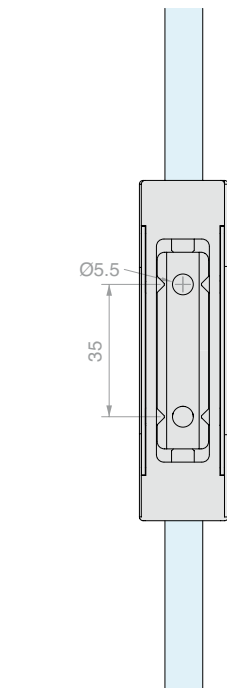
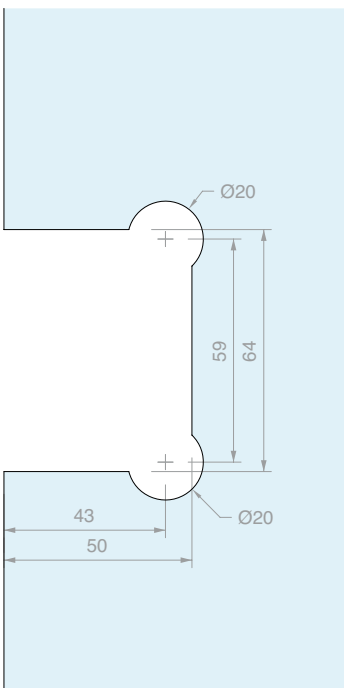
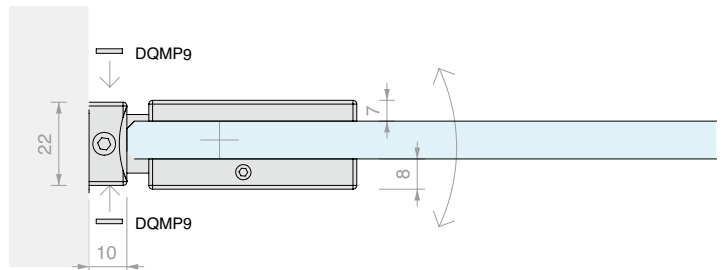
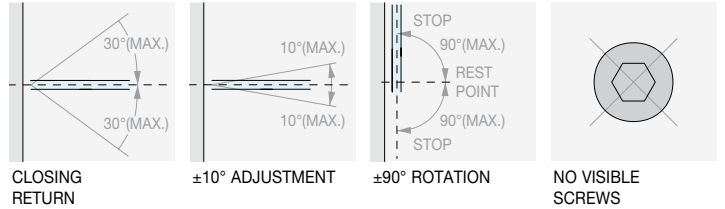
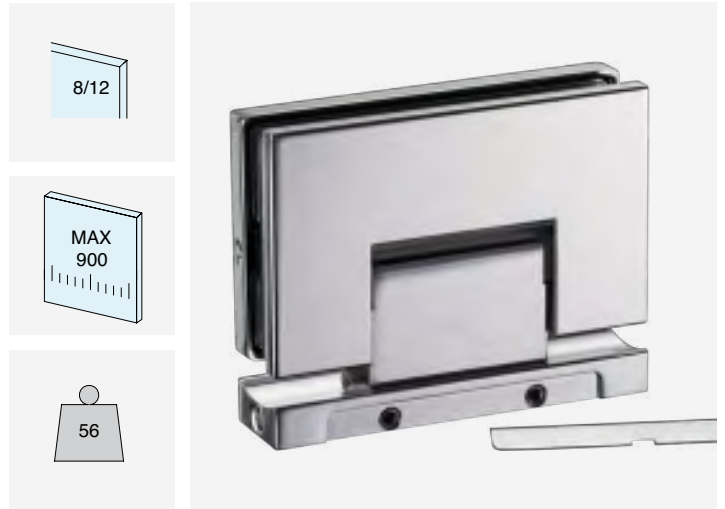

Art.	For glass	Qty
<b>DQ44</b>	From 8 to 12 mm	1 Pc



**WALL/GLASS ADJUSTABLE PIVOT HINGE FOR NARROW DOOR JAMBS**

Material: Brass  
 Finish: /1 /2 /24 /R2  
 Spare plate DQMP9 on p. 235



CLOSING RETURN

±10° ADJUSTMENT

±90° ROTATION

NO VISIBLE SCREWS

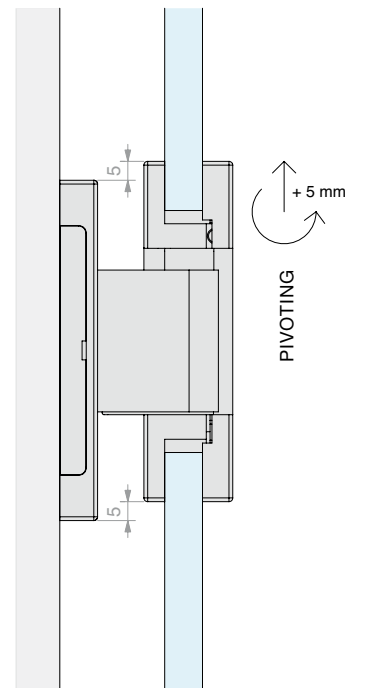
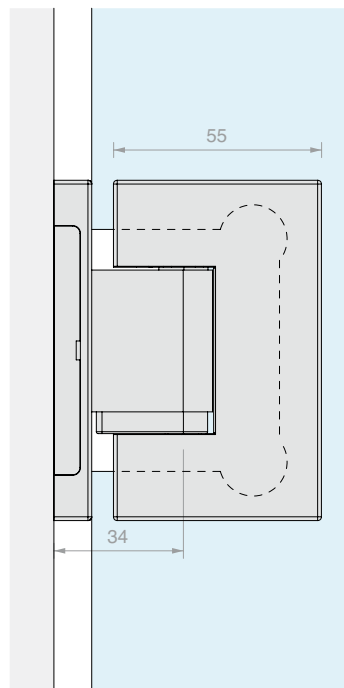
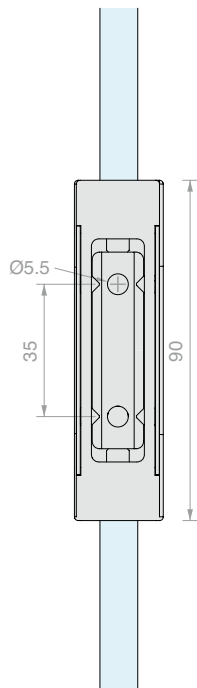
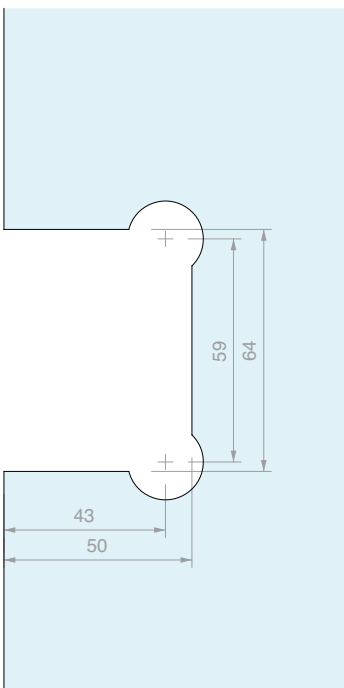
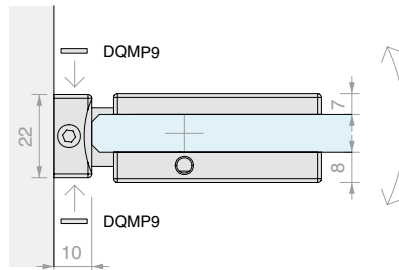

Art.	For glass	Qty
<b>DQ44P</b>	From 8 to 12 mm	1 Pc



**GLASS/GLASS ADJUSTABLE  
IN-LINE HINGE**

Material: Brass  
Finish: /1 /2 /4 /24 /R2



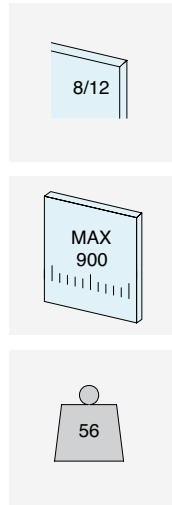



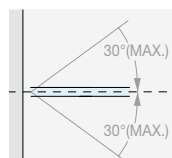

CLOSING RETURN

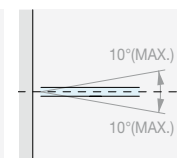

±10° ADJUSTMENT

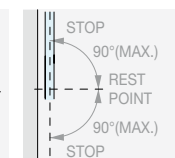

±90° ROTATION

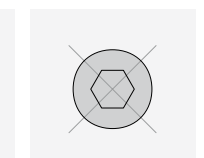

NO VISIBLE SCREWS

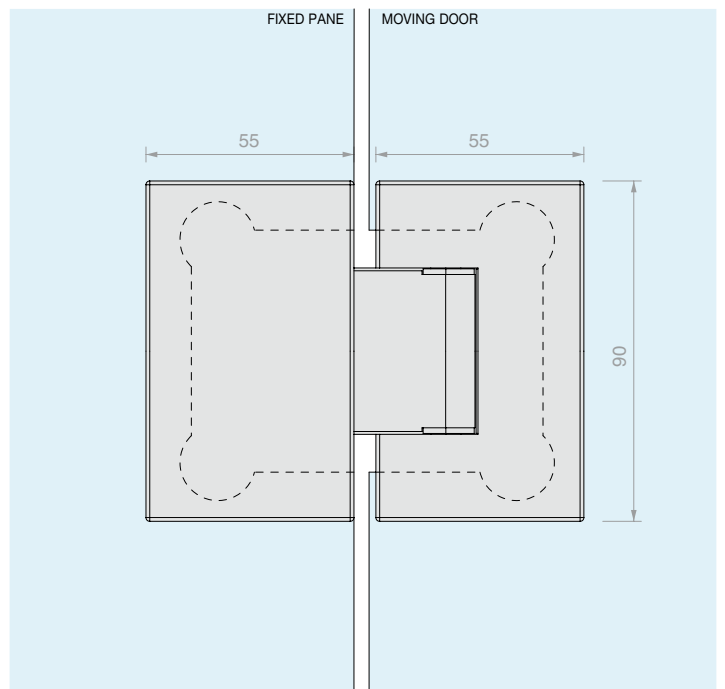
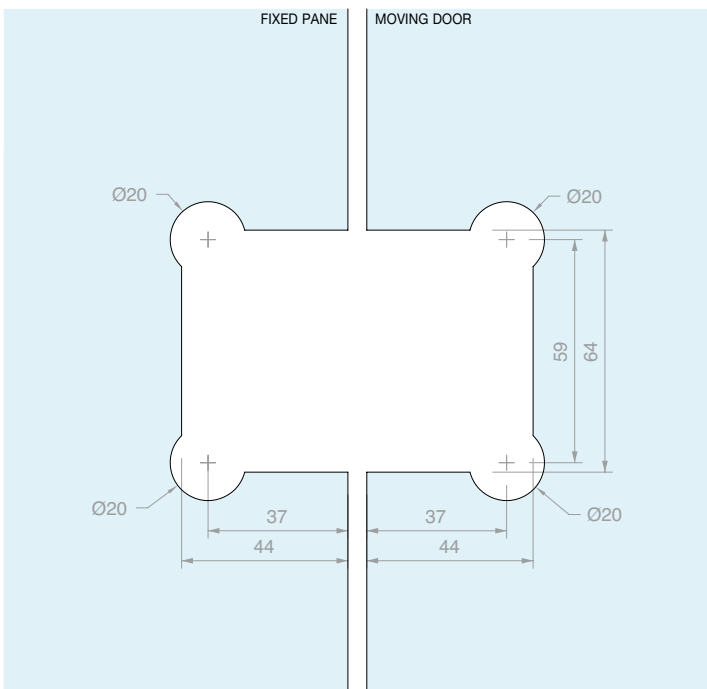
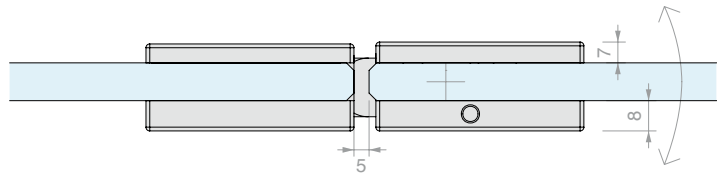

Art. <b>DQ480</b>	For glass From 8 to 12 mm	Qty 1 Pc
----------------------	------------------------------	-------------



**GLASS/GLASS IN-LINE  
ADJUSTABLE PIVOT HINGE**

Material: Brass  
Finish: /1 /2 /24 /R2



8/12

MAX 900

56

CLOSING RETURN

±10° ADJUSTMENT

±90° ROTATION

NO VISIBLE SCREWS

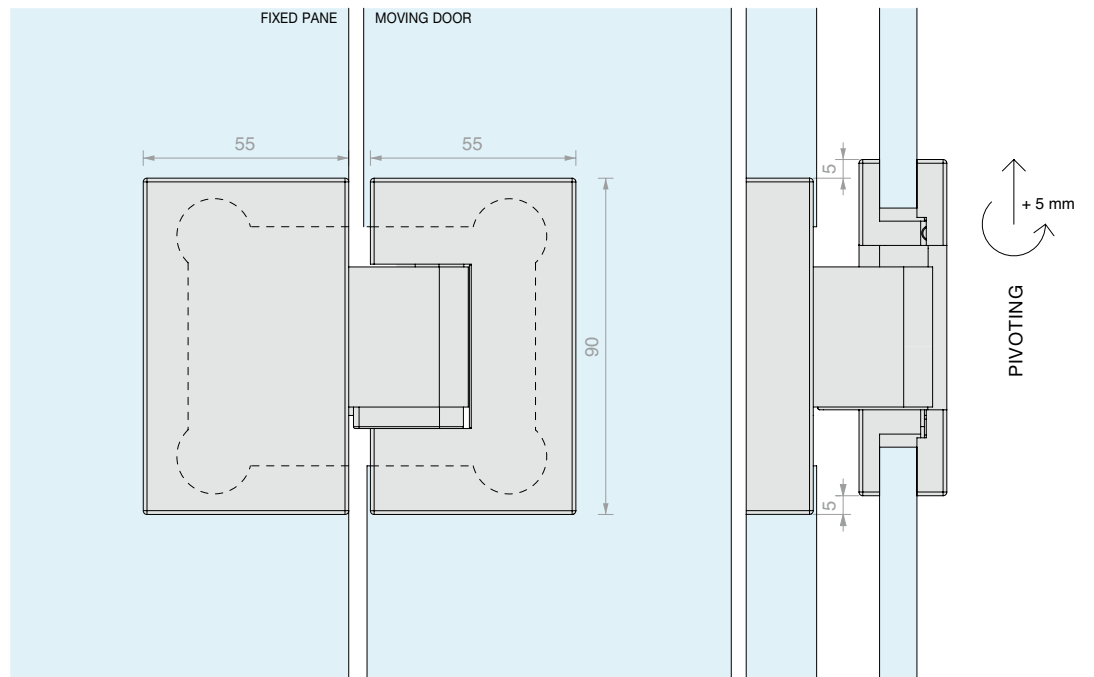
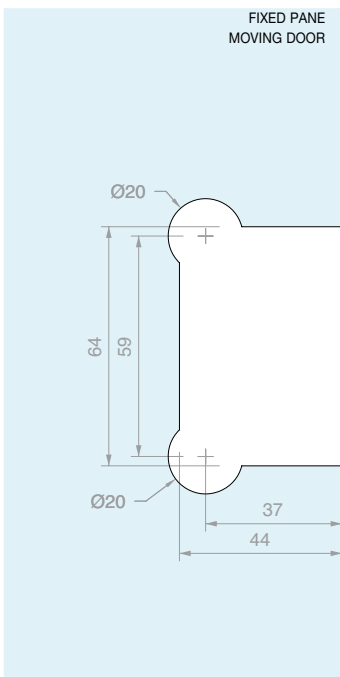
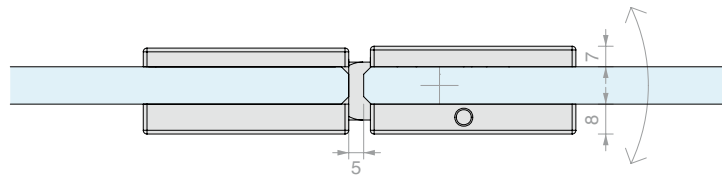

Art. **DQ480P** For glass From 8 to 12 mm

Qty  
1 Pc



**GLASS/GLASS 90°  
ADJUSTABLE HINGE**

Material: Brass  
Finish: /1 /24 /R2

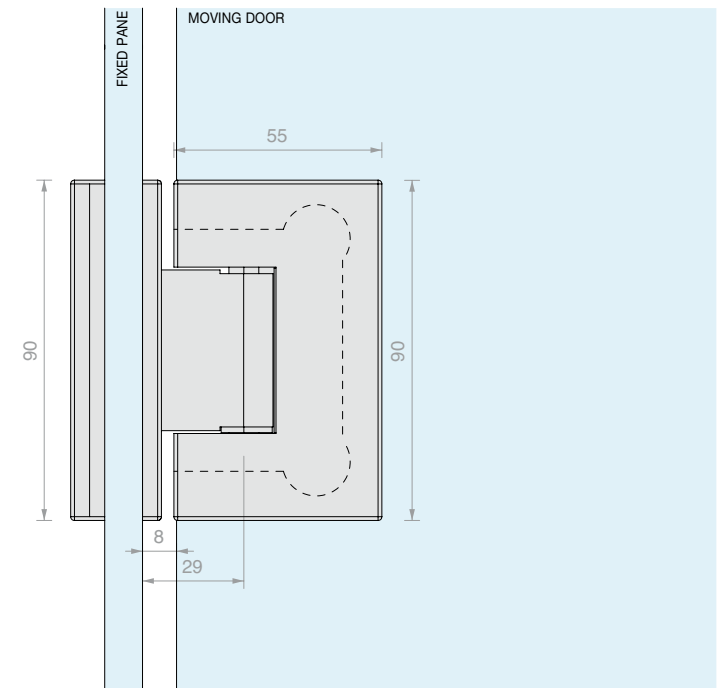
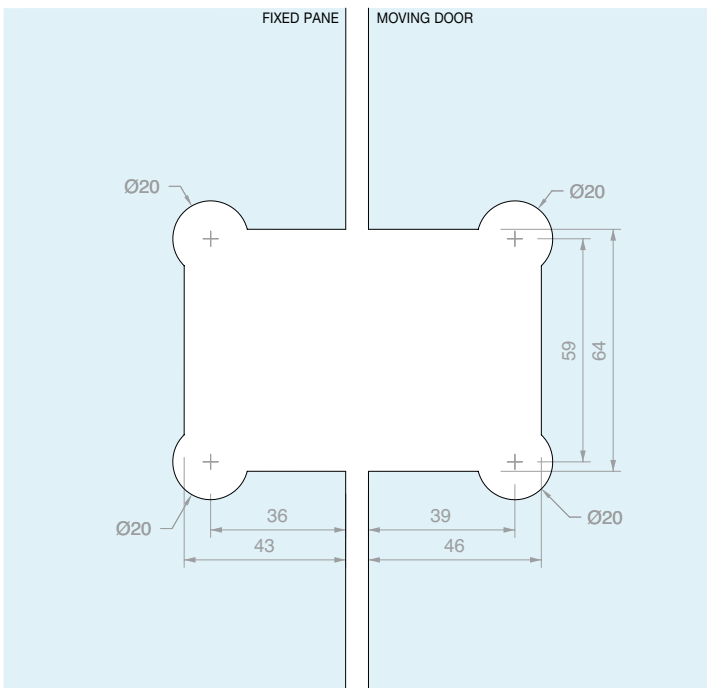
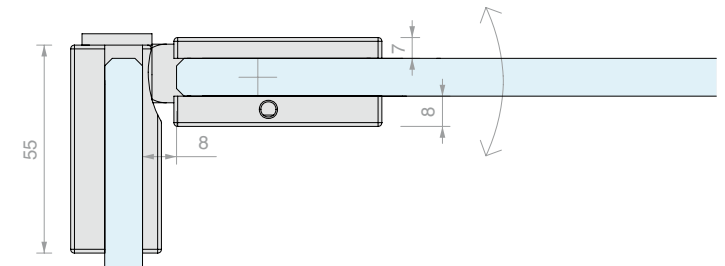
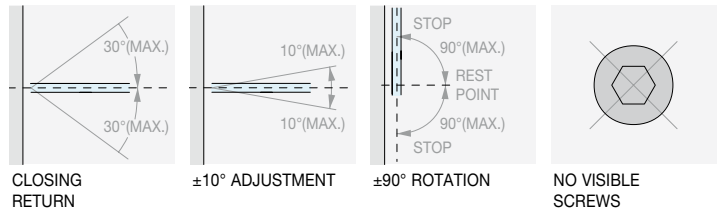

Art. <b>DQ490</b>	For glass From 8 to 12 mm	Qty 1 Pc
----------------------	------------------------------	-------------



**GLASS/GLASS 135°  
ADJUSTABLE HINGE**

Material: Brass  
Finish: /1 /24 /R2

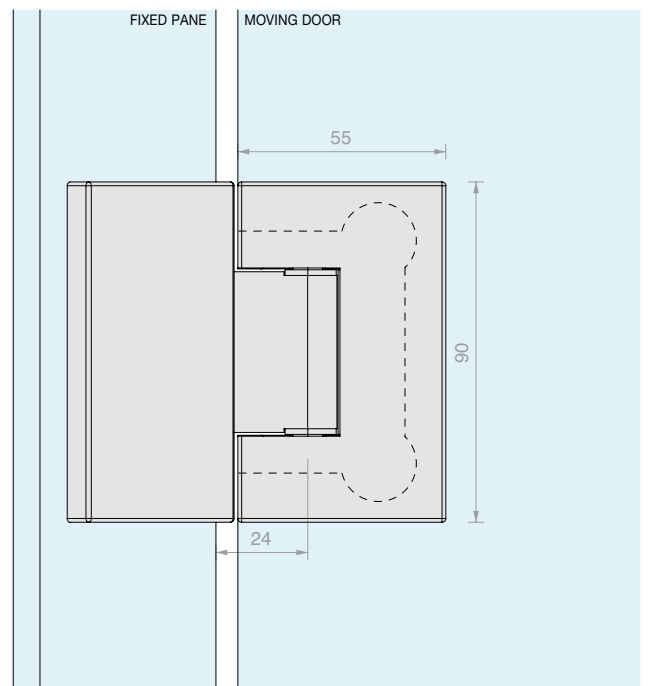
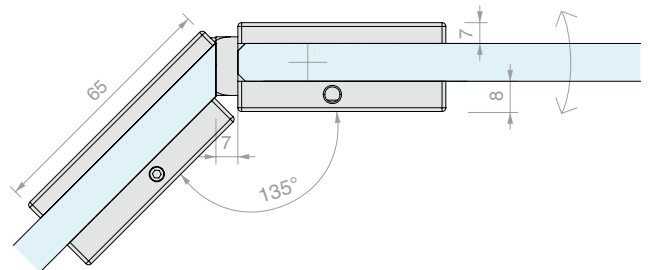
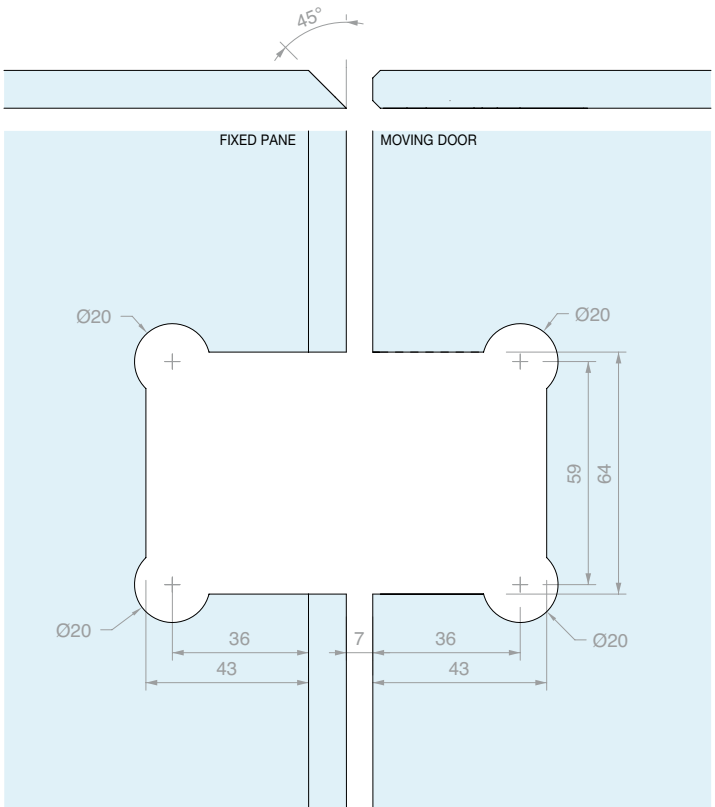

Art. **DQ4135** For glass From 8 to 12 mm

Qty 1 Pc



**WALL/GLASS ADJUSTABLE  
IN-LINE HINGE**

Material: Brass  
Finish: /1 /24  
Spare plate DQMP6 on p. 235

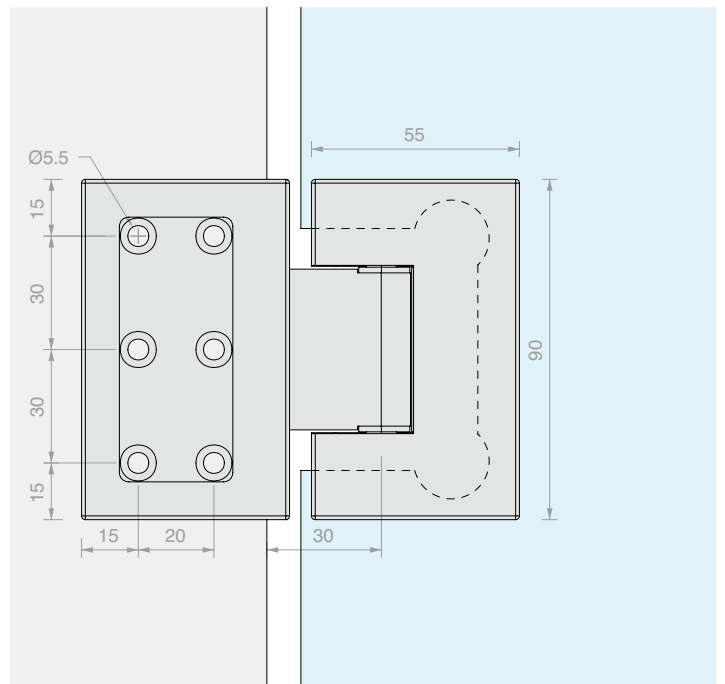
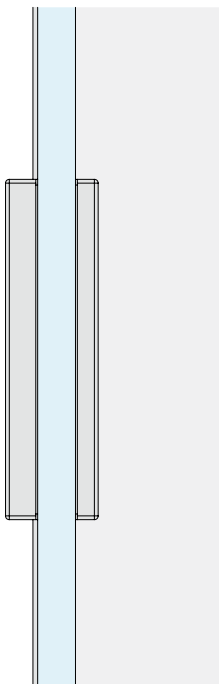
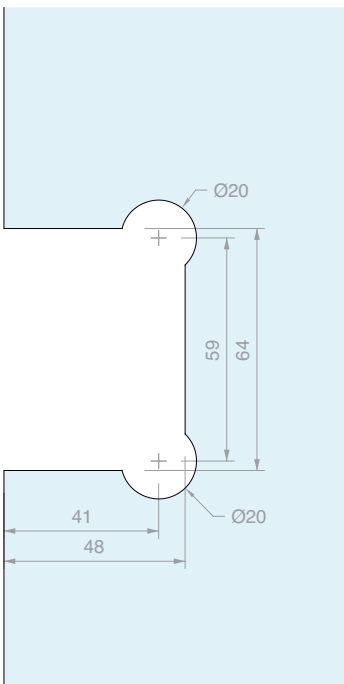
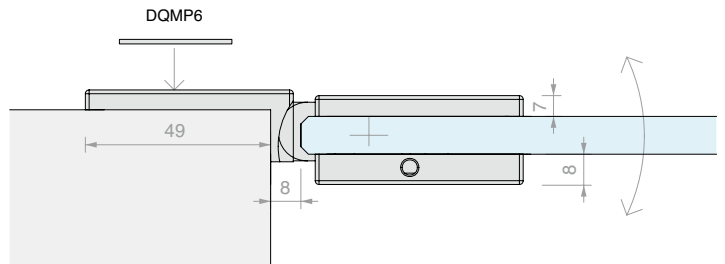

Art. <b>DQ475</b>	For glass From 8 to 12 mm	Qty 1 Pc
----------------------	------------------------------	-------------



**WALL/GLASS 135°  
ADJUSTABLE HINGE**

Material: Brass  
Finish: /1 /24  
Spare plate DQMP6 on p. 235

8/12

MAX  
900

56

CLOSING RETURN

±10° ADJUSTMENT

±90° ROTATION

NO VISIBLE SCREWS

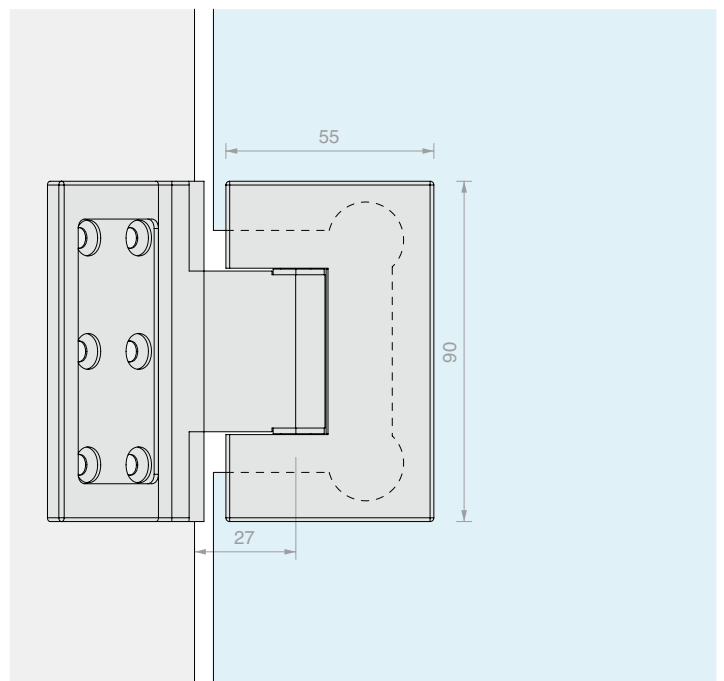
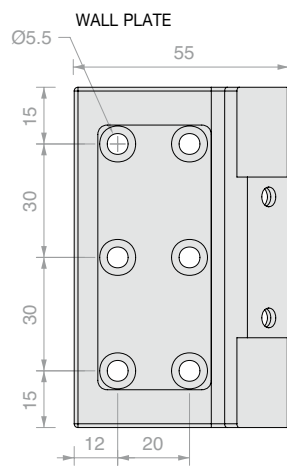
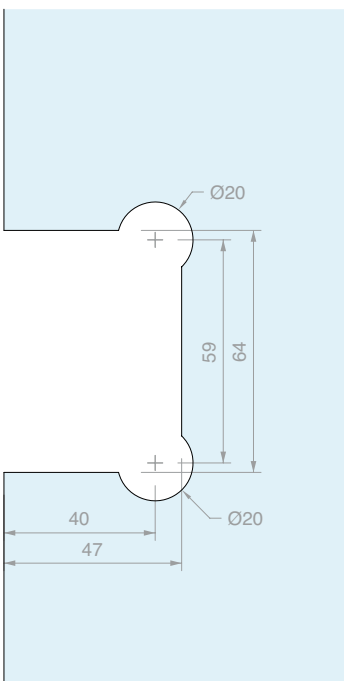
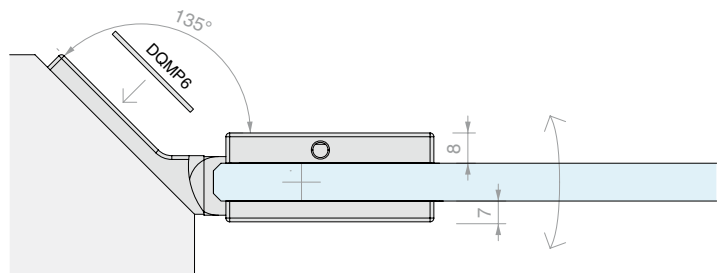

Art. <b>DQ497</b>	For glass From 8 to 12 mm	Qty 1 Pc
----------------------	------------------------------	-------------







**CLOSURE WITH DOOR KNOB AND KEY LOCK**

Material: Brass  
 Finish: /1 /2 /4 /24 /R2

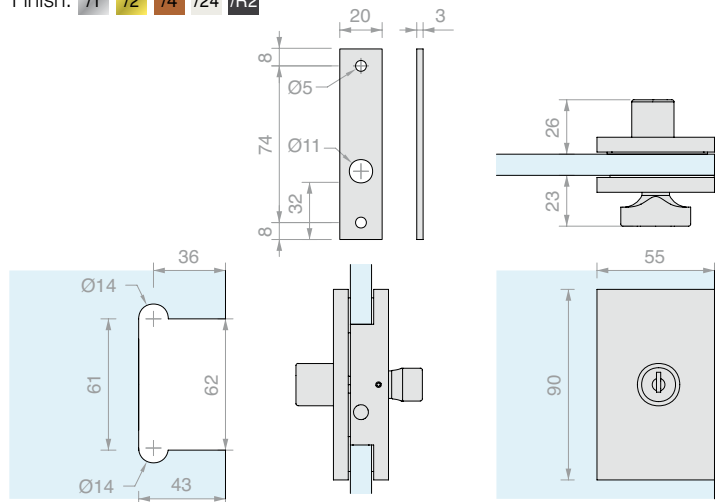

Art.	Pin	For glass	Key	Qty
<b>DQC51</b>	$\varnothing 7$ L 15.5 mm	From 10 to 12 mm	Different	1 Pc



**CLOSURE WITH DOOR KNOB, KEY LOCK AND HANDLES**

Material: Brass  
 Finish: /1 /24

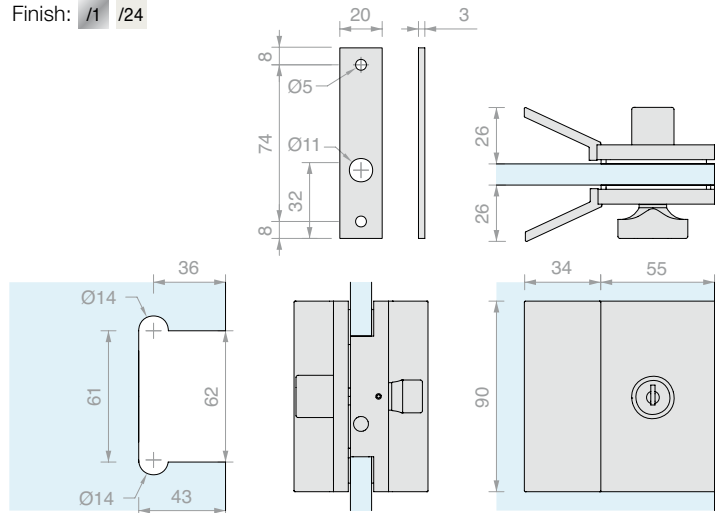

Art.	Pin	For glass	Key	Qty
<b>DQC53</b>	$\varnothing 7$ L 15.5 mm	From 10 to 12 mm	Different	1 Pc



**LOCK WITH DOUBLE DOOR KNOB**

Material: Brass  
 Finish: /1 /24

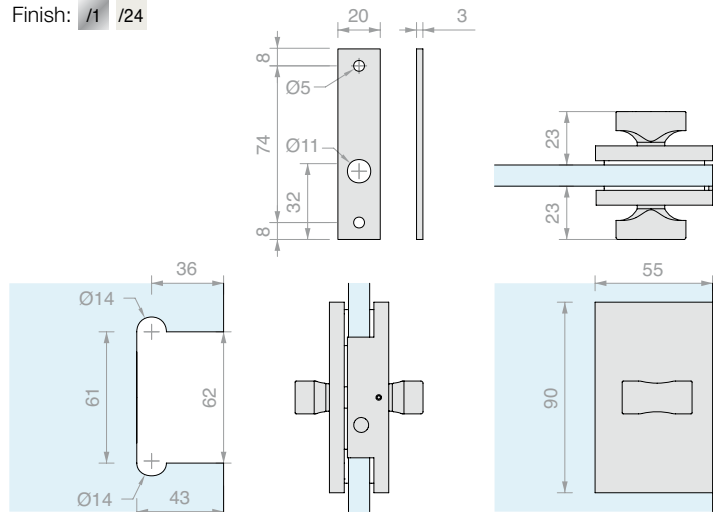

Art.	Pin	For glass	Qty
<b>DQC55</b>	$\varnothing 7$ L 15.5 mm	From 10 to 12 mm	1 Pc



**LOCK WITH DOUBLE DOOR KNOB AND HANDLES**

Material: Brass

Finish: /1 /24

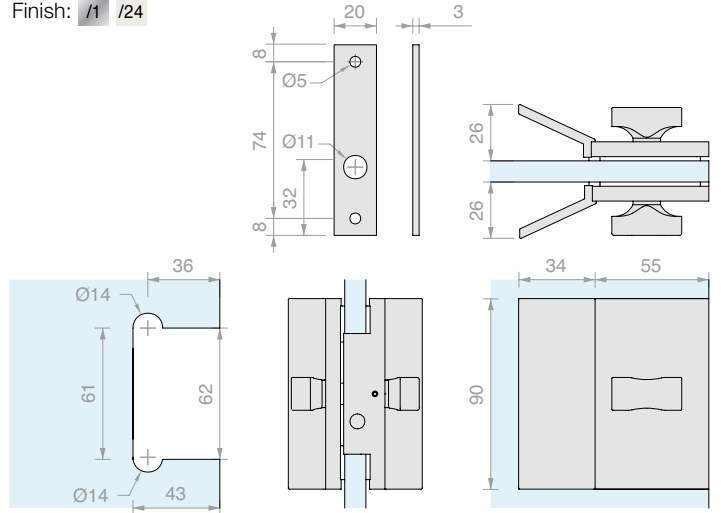

Art.	Pin	For glass	Qty
<b>DQC575</b>	Ø7 L 15.5 mm	From 10 to 12 mm	1 Pc



**FREE/OCCUPIED LOCK WITH DOOR KNOB**

Material: Brass

Finish: /1 /24

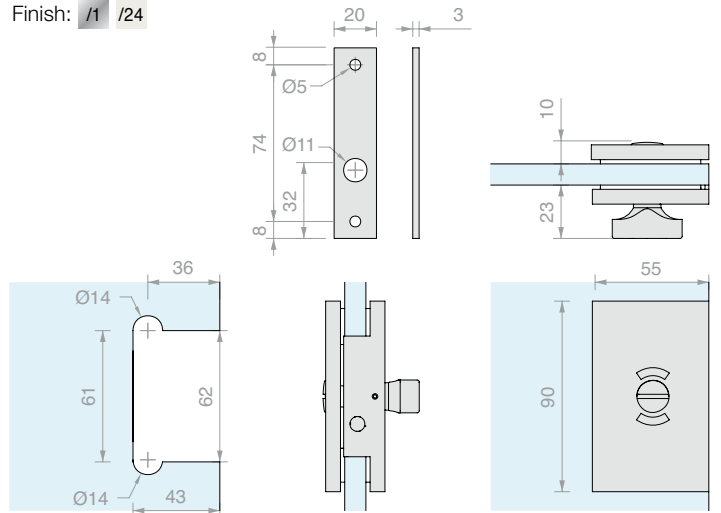

Art.	Pin	For glass	Qty
<b>DQC58</b>	Ø7 L 15.5 mm	From 10 to 12 mm	1 Pc



**FREE/OCCUPIED CLOSURE WITH DOOR KNOB AND HANDLES**

Material: Brass

Finish: /1 /24

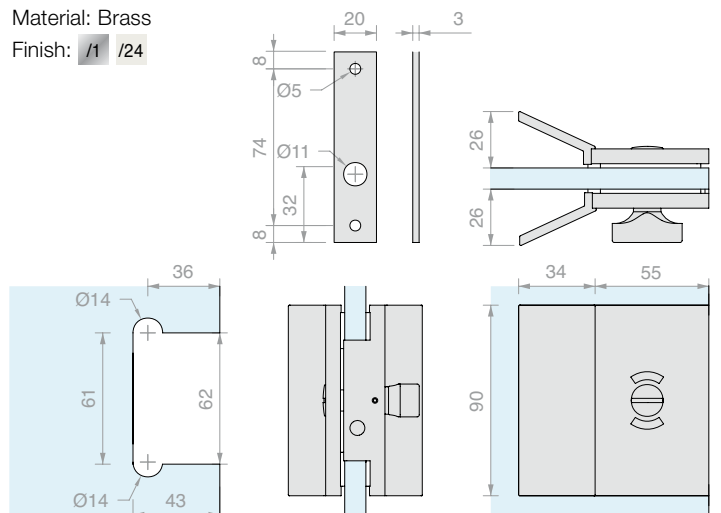

Art.	Pin	For glass	Qty
<b>DQC59</b>	Ø7 L 15.5 mm	From 10 to 12 mm	1 Pc



**STRIKE PLATE FOR GLASS**

Material: Brass  
 Finish: /1 /2 /4 /24 /R2

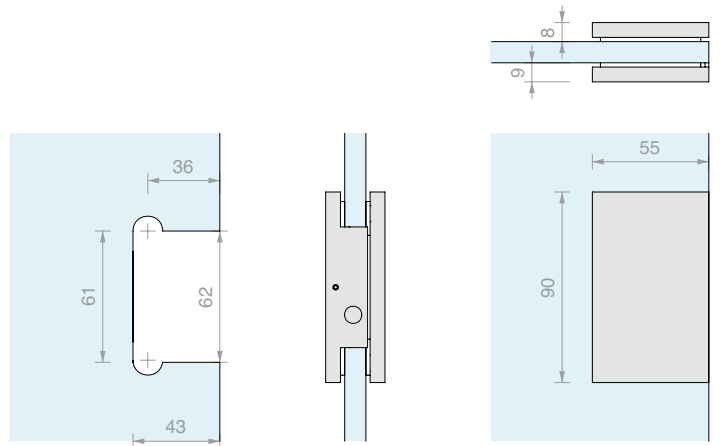

Art.	For glass	Qty
<b>DQC61</b>	From 10 to 12 mm	1 Pc



**BOLT**

Material: Brass  
 Finish: /1 /24

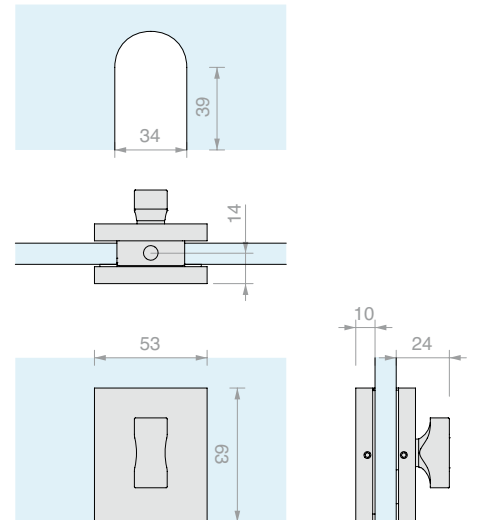

Art.	Pin	For glass	Qty
<b>DQC63</b>	Ø7.5 L 13.5 mm	From 10 to 12 mm	1 Pc



**BOLT STRIKE PLATE**

Material: Brass  
 Finish: /1 /24

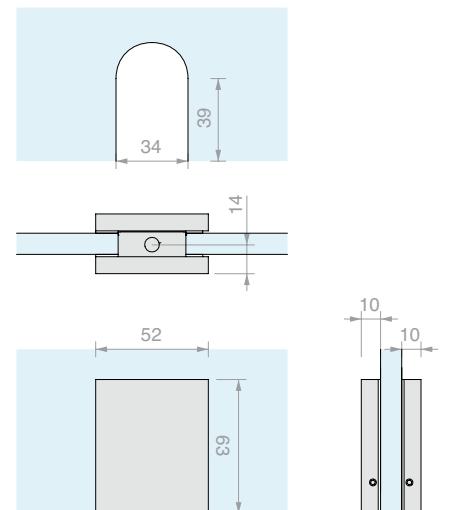

Art.	For glass	Qty
<b>DQC65</b>	From 10 to 12 mm	1 Pc



**WALL/GLASS FLUSH TO WALL CLAMP**

Material: Brass  
 Invisible screws  
 Finish: /1 /2 /4 /24 /R2  
 Spare plate DQMP2 on p. 235

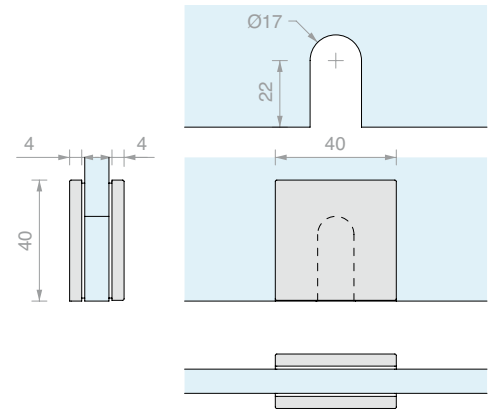

Art.	For glass	Qty
<b>DQM41</b>	From 6 to 12 mm	1 Pc



**WALL/GLASS CLAMP**

Material: Brass  
 Invisible screws  
 Finish: /1 /24 /R2  
 Spare plate DQMP2 on p. 235

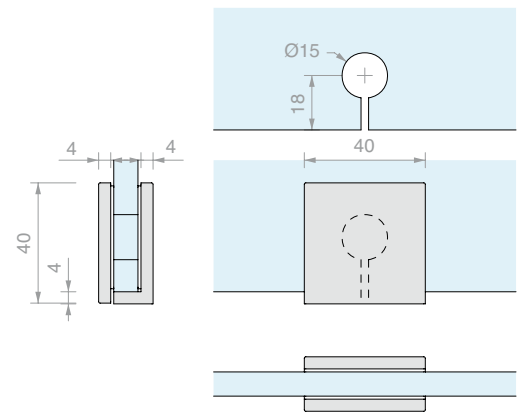

Art.	For glass	Qty
<b>DQM43</b>	From 6 to 12 mm	1 Pc



**WALL/GLASS SIDE FIXING CLAMP, NARROW**

Material: Brass  
 Invisible screws  
 Finish: /1 /2 /4 /24 /R2  
 Spare plate DQMP2 and DQPM4 on page 235

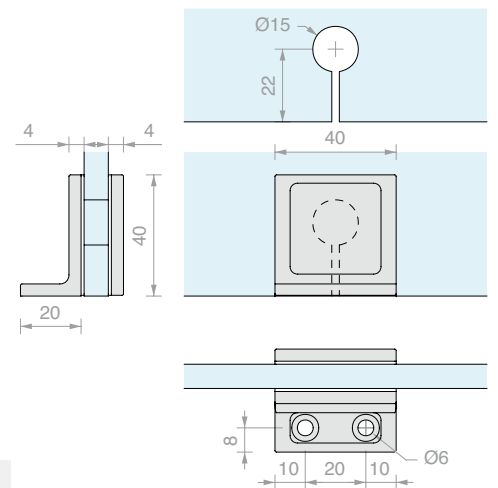

Art.	For glass	Qty
<b>DQM57</b>	From 6 to 12 mm	1 Pc



**WALL/GLASS SIDE FIXING CLAMP, LARGE**

Material: Brass  
 Invisible screws  
 Finish: /1 /24 /R2  
 Spare plate DQMP2 on p. 235

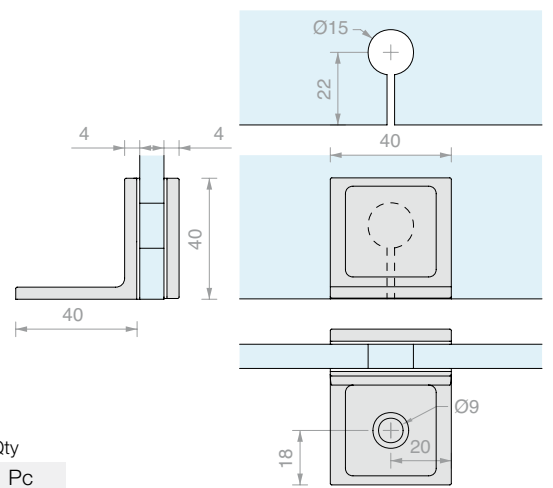

Art.	For glass	Qty
<b>DQM52</b>	From 6 to 12 mm	1 Pc



**WALL/GLASS IN-LINE CLAMP**

Material: Brass  
 Invisible screws  
 Finish: /1 /24 /R2  
 Spare plate DQMP2 on p. 235

Art.	For glass	Qty
<b>DQM50</b>	From 6 to 12 mm	1 Pc

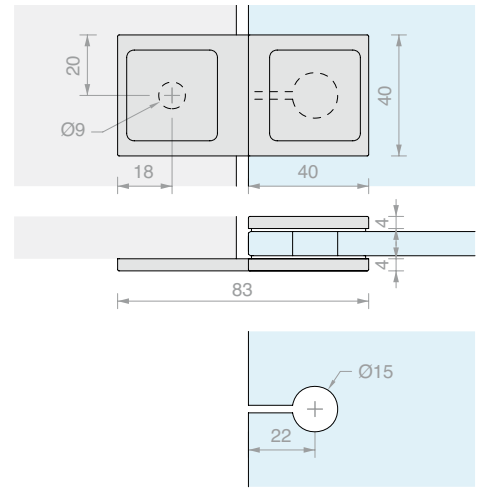

**WALL/GLASS 135° CLAMP**

Material: Brass  
 Invisible screws  
 Finish: /1 /24  
 Spare plate DQMP2 on p. 235

Art.	For glass	Qty
<b>DQM54</b>	From 6 to 12 mm	1 Pc

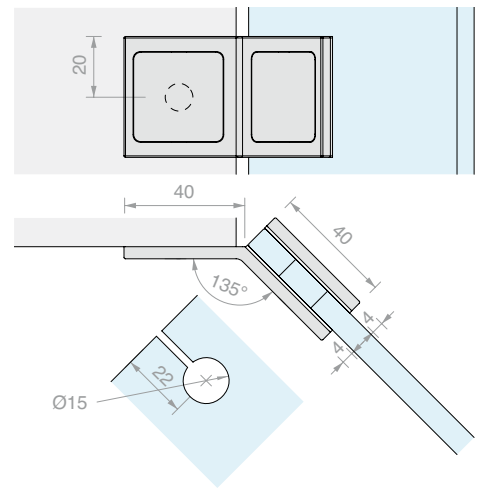

**GLASS/GLASS 90° CLAMP**

Material: Brass  
 Invisible screws  
 Finish: /1 /2 /4 /24 /R2  
 Spare plate DQMP2 on p. 235

Art.	For glass	Qty
<b>DQM47</b>	From 6 to 12 mm	1 Pc

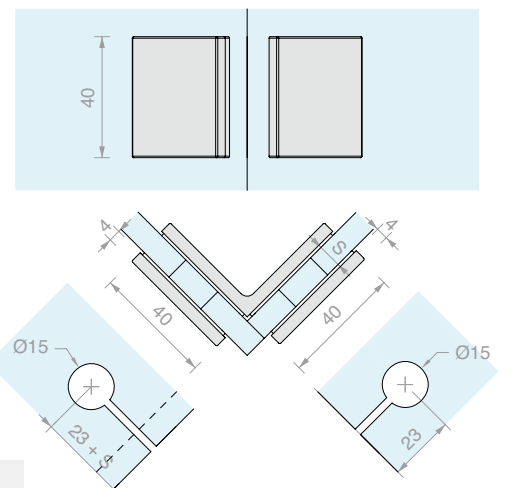

**GLASS/GLASS IN-LINE CLAMP**

Material: Brass  
 Invisible screws  
 Finish: /1 /24 /R2  
 Spare plate DQMP2 on p. 235

Art.	For glass	Qty
<b>DQM45</b>	From 6 to 12 mm	1 Pc

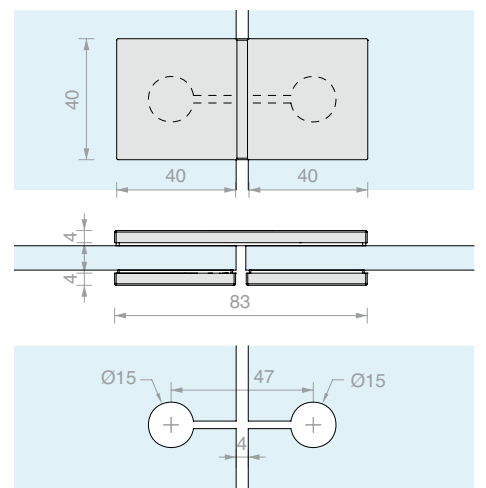



**GLASS/GLASS 135° CLAMP**

Material: Brass  
 Invisible screws  
 Finish: /1 /24  
 Spare plate DQMP2 on p. 235

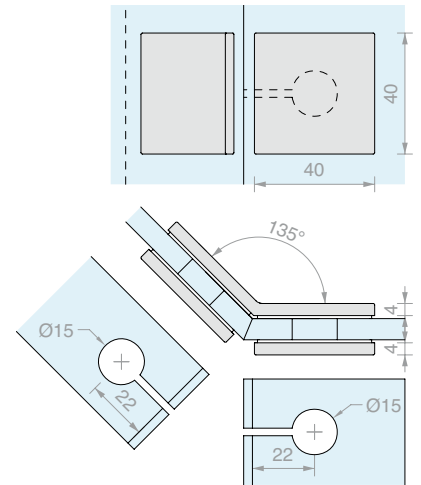

Art.	For glass	Qty
<b>DQM49</b>	From 6 to 12 mm	1 Pc



**WALL/GLASS CLAMP**

Material: Brass  
 Invisible screws  
 Finish: /1 /24 /R2  
 Spare plate DQMP6 on p. 235

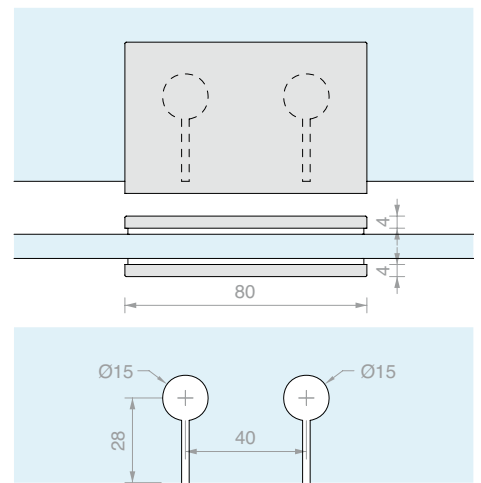
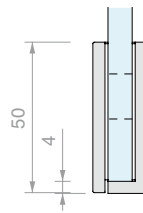

Art.	For glass	Qty
<b>DQM09</b>	From 6 to 12 mm	1 Pc



**WALL/GLASS SIDE FIXING CLAMP, NARROW**

Material: Brass  
 Invisible screws  
 Finish: /1 /2 /4 /24 /R2  
 Spare plate DQMP6 and DQMP7 on p. 235

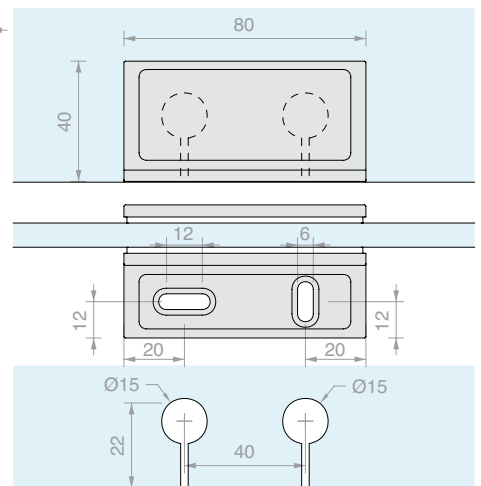
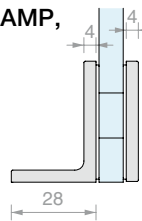

Art.	For glass	Qty
<b>DQM11</b>	From 6 to 12 mm	1 Pc



**GLASS/GLASS 90° CLAMP**

Material: Brass  
 Invisible screws  
 Finish: /1 /24  
 Spare plate DQMP6 on p. 235

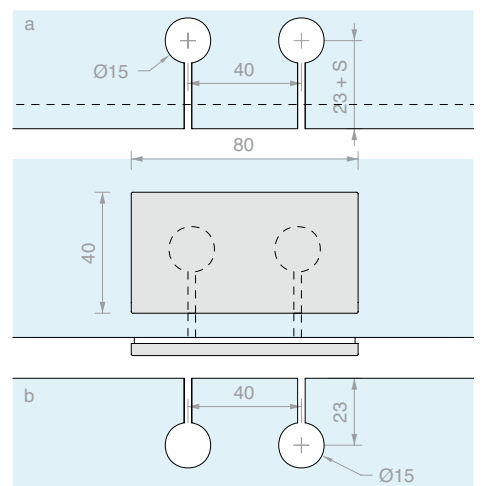
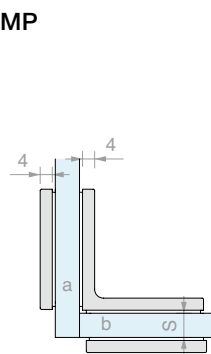

Art.	For glass	Qty
<b>DQM07</b>	From 6 to 12 mm	1 Pc



**WALL/GLASS FIXED STABILIZER BAR WITH SHORT CLAMP**

Material: Brass

Finish: /1 /2 /4 /24 /R2

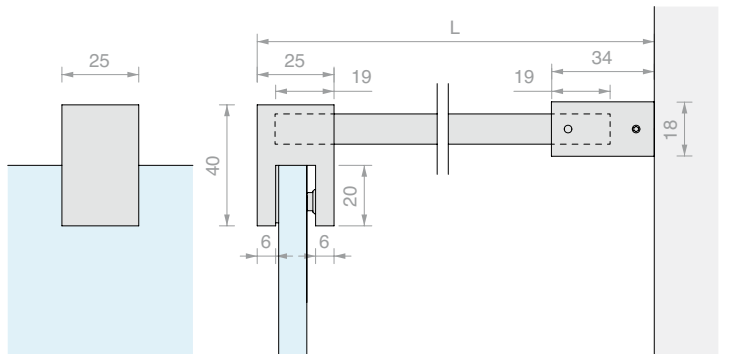

Art.	L	For glass	Qty
<b>DQT500</b>	<b>520 mm</b>	From 8 to 12 mm	1 Pc
<b>DQT1000</b>	<b>1020 mm</b>	From 8 to 12 mm	1 Pc
<b>DQT1500</b>	<b>1520 mm</b>	From 8 to 12 mm	1 Pc



**WALL/GLASS FIXED STABILIZER BAR WITH TALL CLAMP**

Material: Brass

Finish: /1 /24

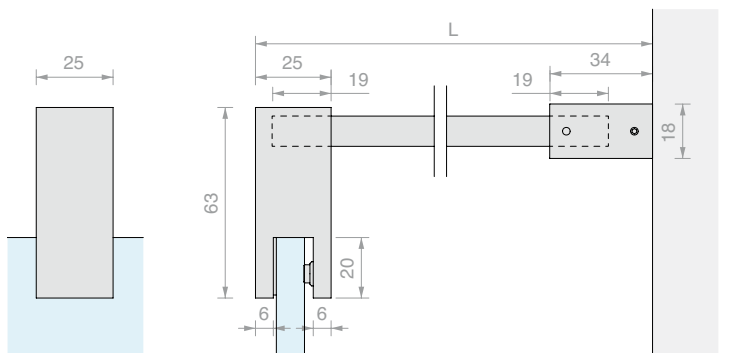
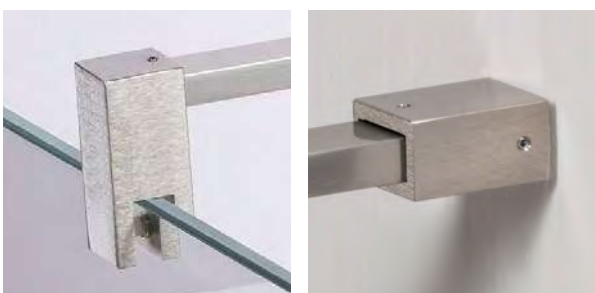

Art.	L	For glass	Qty
<b>DQX500</b>	<b>520 mm</b>	From 8 to 12 mm	1 Pc
<b>DQX1000</b>	<b>1020 mm</b>	From 8 to 12 mm	1 Pc
<b>DQX1500</b>	<b>1520 mm</b>	From 8 to 12 mm	1 Pc





**WALL/GLASS STABILIZER BAR WITH WALL JOINT AND SHORT CLAMP**

Material: Brass

Finish: /1 /2 /4 /24 /R2

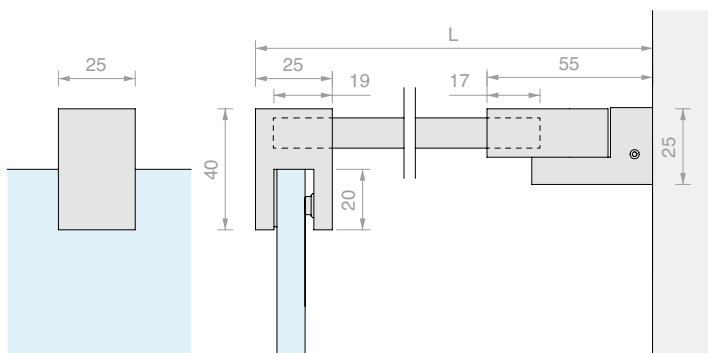

Art.	L	For glass	Qty
<b>DQA500</b>	<b>541 mm</b>	From 8 to 12 mm	1 Pc
<b>DQA1000</b>	<b>1041 mm</b>	From 8 to 12 mm	1 Pc
<b>DQA1500</b>	<b>1541 mm</b>	From 8 to 12 mm	1 Pc



**WALL/GLASS STABILIZER BAR WITH DOUBLE JOINT**

Material: Brass

Finish: /1 /2 /4 /24 /R2

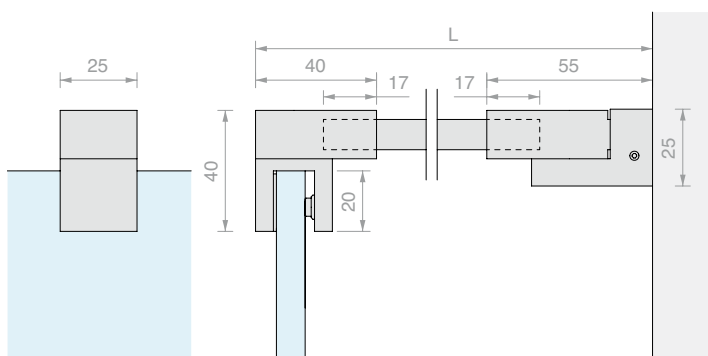
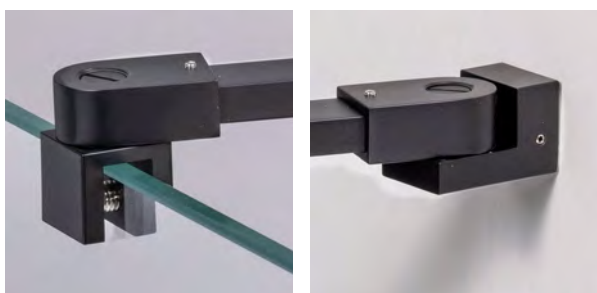

Art.	L	For glass	Qty
<b>DQA55</b>	<b>557 mm</b>	From 8 to 12 mm	1 Pc
<b>DQA65</b>	<b>1057 mm</b>	From 8 to 12 mm	1 Pc
<b>DQA75</b>	<b>1557 mm</b>	From 8 to 12 mm	1 Pc



**RECTANGULAR BAR**

Material: Brass

Finish: /1 /2 /4 /24 /R2

Art.	Length	Qty
<b>DQA05</b>	500 mm	1 Pc
<b>DQA06</b>	1000 mm	1 Pc
<b>DQA08</b>	1500 mm	1 Pc

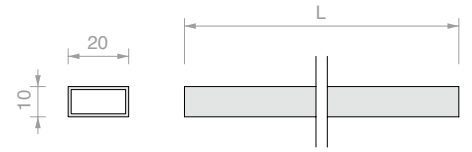

**GLASS IN-LINE THROUGH FIXING**

Material: Brass

Finish: /1 /24

Art.	For glass	Qty
<b>DQA83</b>	From 8 to 12 mm	1 Pc

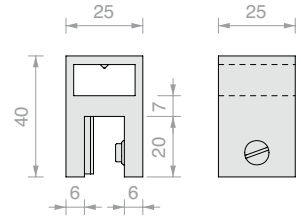

**ARTICULATED GLASS FIXING**

Material: Brass

Finish: /1 /2 /4 /24 /R2

Art.	For glass	Qty
<b>DQA85</b>	From 8 to 12 mm	1 Pc

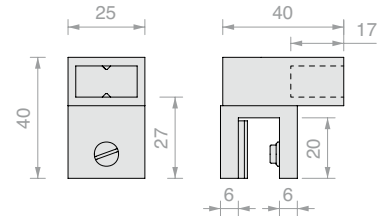

**SHORT CLOSED GLASS FIXING**

Material: Brass

Finish: /1 /2 /4 /24 /R2

Art.	For glass	Qty
<b>DQA86</b>	From 8 to 12 mm	1 Pc

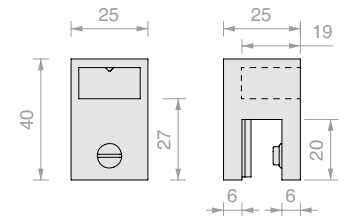

**TALL CLOSED GLASS FIXING**

Material: Brass

Finish: /1 /24

Art.	For glass	Qty
<b>DQA8670</b>	From 8 to 12 mm	1 Pc

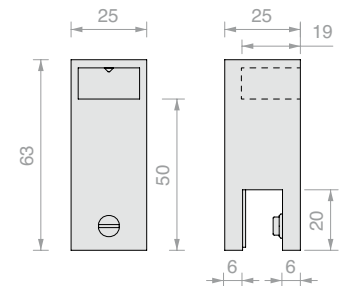

**90° GLASS THROUGH FIXING**

Material: Brass

Finish: /1 /24

Art.	For glass	Qty
<b>DQA87</b>	From 8 to 12 mm	1 Pc

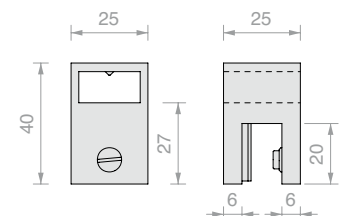



**ARTICULATED DISTANCED GLASS FIXING**

Material: Brass  
 Finish: /1 /2 /4 /24 /R2

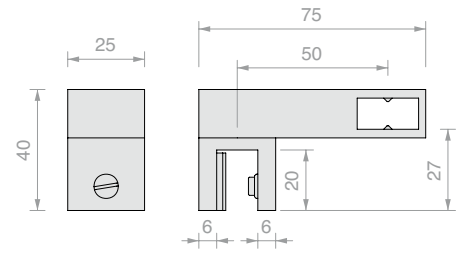

Art.	For glass	Qty
<b>DQA90</b>	From 8 to 12 mm	1 Pc



**WALL FIXING**

Material: Brass  
 Finish: /1 /2 /4 /24 /R2

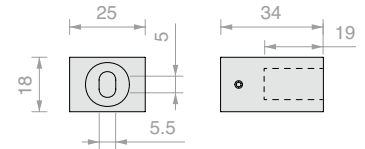
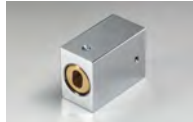

Art.	Qty
<b>DQA93</b>	1 Pc

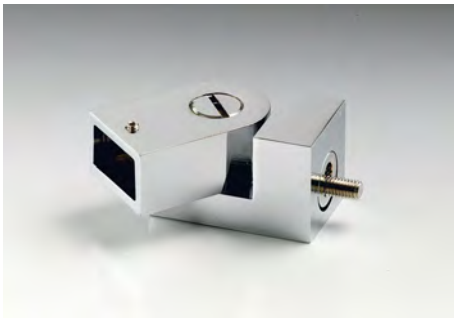

**ARTICULATED WALL FIXING**

Material: Brass  
 Finish: /1 /2 /4 /24 /R2

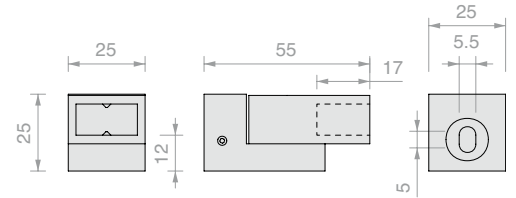

Art.	Qty
<b>DQA88</b>	1 Pc

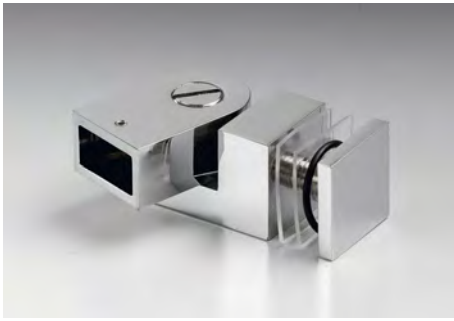

**ARTICULATED GLASS FIXING**

Material: Brass  
 Recommended hole size Ø14 mm  
 Finish: /1 /24

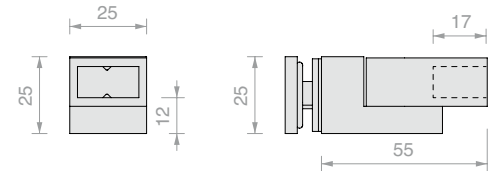

Art.	For glass	Qty
<b>DQA89</b>	From 8 to 12 mm	1 Pc



**ARTICULATED JUNCTION**

Material: Brass  
 Finish: /1 /24

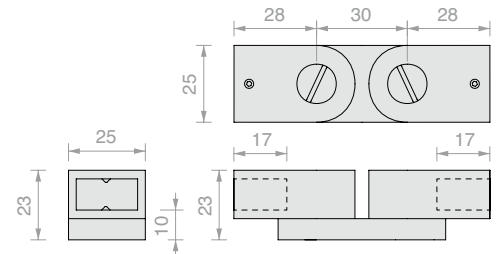

Art.	Qty
<b>DQA99</b>	1 Pc



**SPARE PLATE WITH TWO-SIDED ADHESIVE**

Material: Brass  
 Finish: /1 /2 /4 /24 /R2

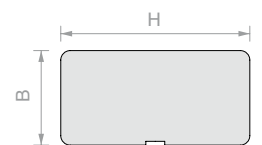

Art.	H	B	Qty
<b>DQMP2</b>	29.6 mm	29.6 mm	1 Pc
<b>DQMP4</b>	29.6 mm	9.6 mm	1 Pc
<b>DQMP6</b>	69.6 mm	29.6 mm	1 Pc
<b>DQMP7</b>	69.6 mm	17.6 mm	1 Pc
<b>DQMP8</b>	79.6 mm	25.1 mm	1 Pc

Material: AISI 304 steel  
 Finish: /2 /8 /15 /R2

Art.	H	B	Qty
<b>DQMP9</b>	65.6 mm	6.6 mm	1 Pc



**PAIR OF SQUARE KNOBS WITH GRIP**

Material: Brass  
 Recommended glass hole minimum size Ø12 mm  
 Finish: /1 /2 /4 /24 /R2

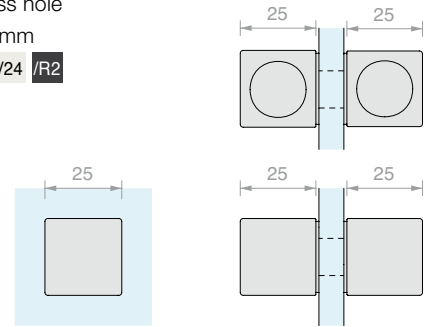

Art.	For glass	Qty
<b>DQTS2525</b>	From 8 to 12 mm	1 Pc



**PAIR OF SQUARE KNOBS**

Material: Brass  
 Recommended glass hole minimum size Ø8 mm  
 Finish: /1 /2 /3 /4 /R2

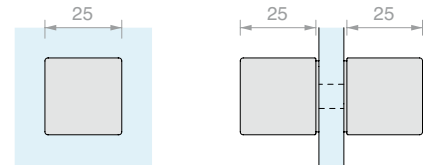

Art.	For glass	Qty
<b>DQP2525</b>	From 8 to 15 mm	1 Pc



**PAIR OF LONG KNOBS**

Material: Brass  
 Recommended glass hole minimum size Ø8 mm  
 Finish: /1 /2 /3 /4 /R2

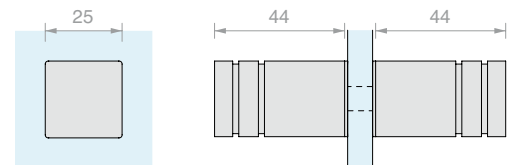

Art.	For glass	Qty
<b>POM2525</b>	From 8 to 15 mm	1 Pc



**HOOK FOR GLASS PANES**

Material: Brass  
 Recommended glass hole minimum size Ø14 mm  
 Finish: /1 /24

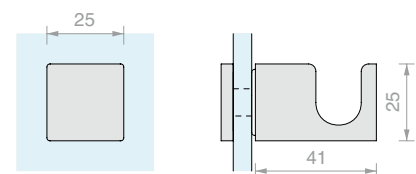

Art.	For glass	Qty
<b>DQP385</b>	From 8 to 12 mm	1 Pc

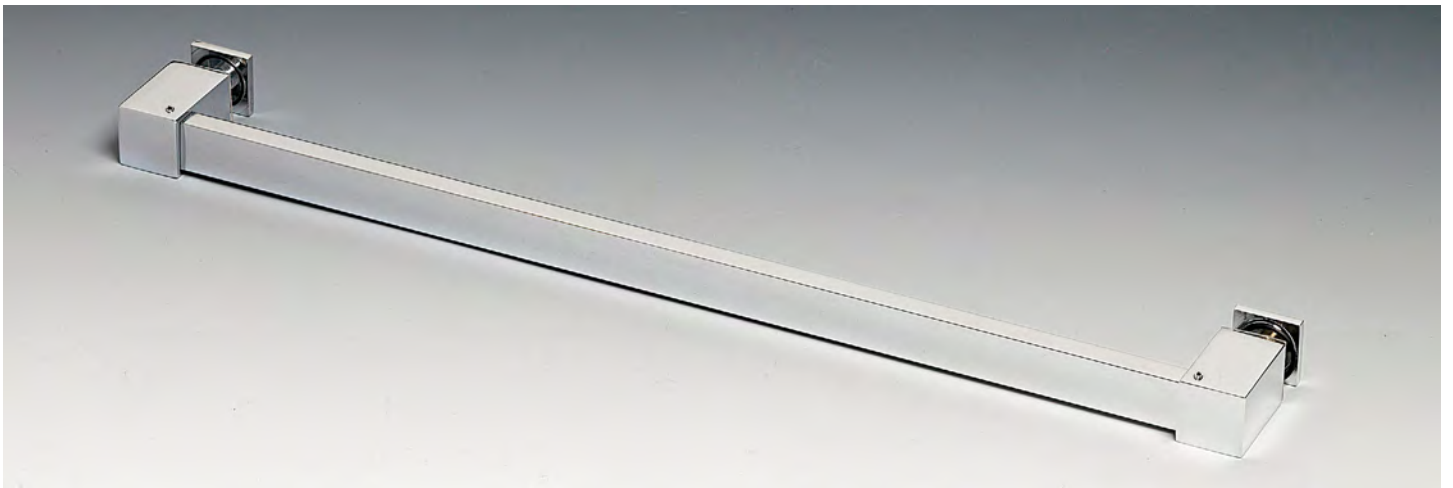

**TOWEL RACK**

Material: Brass

Recommended hole size Ø14 mm

Finish: /1 /2 /4 /24 /R2

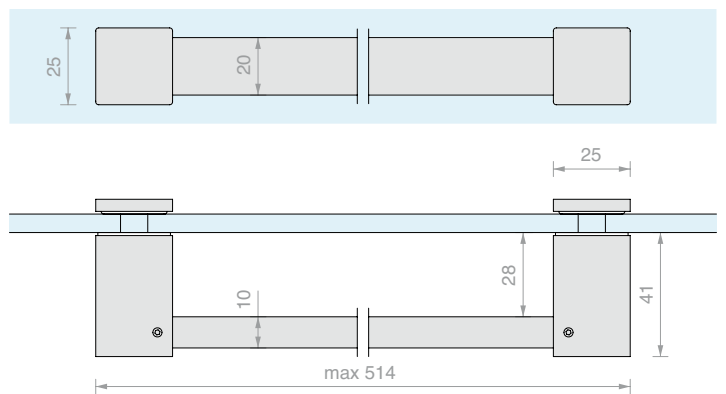

Art.	For glass	Qty
<b>DQP365</b>	From 8 to 12 mm	1 Pc

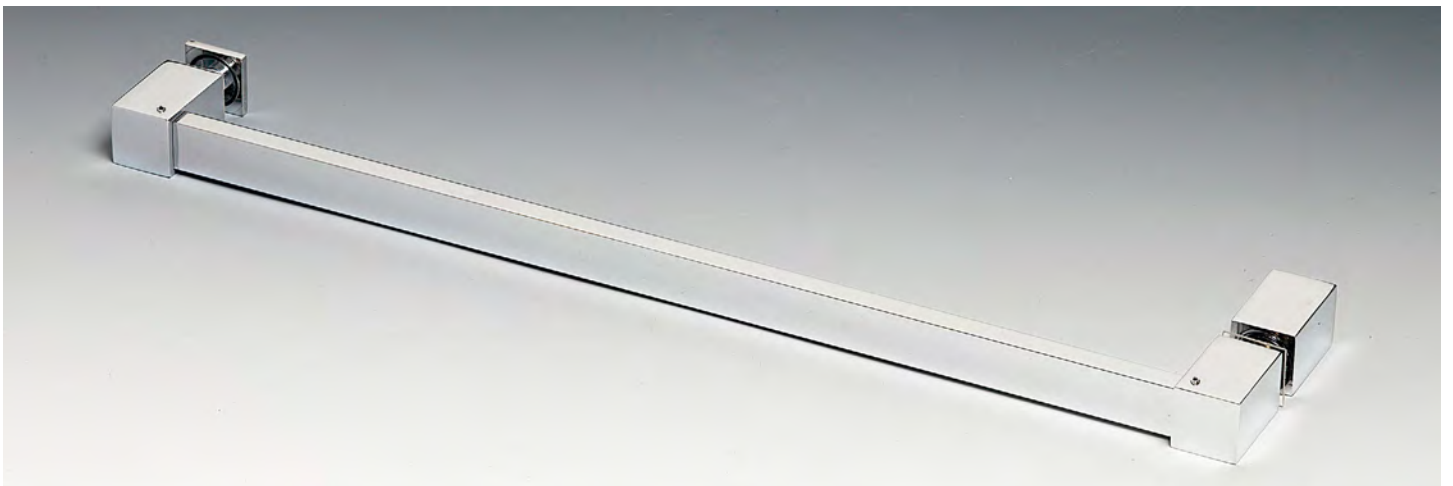

**TOWEL RACK WITH KNOB**

Material: Brass

Recommended hole size Ø14 mm

Finish: /1 /2 /4 /24 /R2

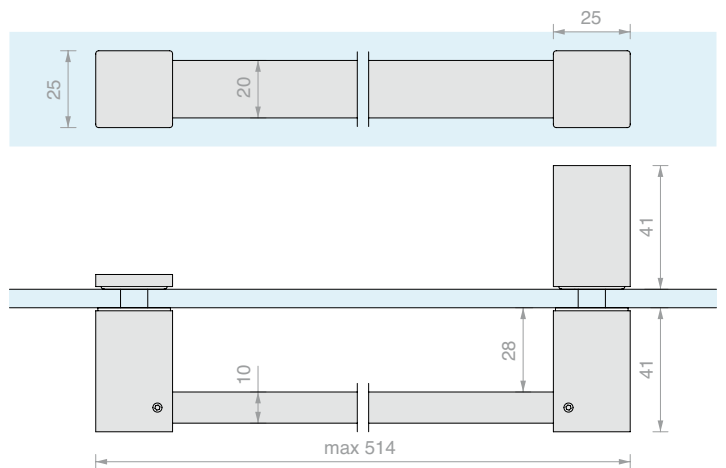

Art.	For glass	Qty
<b>DQP375</b>	From 8 to 12 mm	1 Pc



**LMU20B U-SHAPED PROFILE**

Material: Brass

Finish: /1 /2 /4 /24 /R2

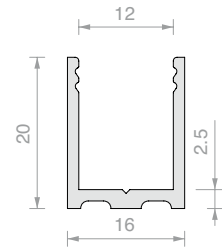

Art.	Length	Qty
<b>LMU20B.150</b>	<b>1498 mm</b>	<b>1 Pc</b>
<b>LMU20B.220</b>	<b>2200 mm</b>	<b>1 Pc</b>
<b>LMU20B.300</b>	<b>3000 mm</b>	<b>1 Pc</b>



**LMU86B FLAT UPPER PROFILE**

Material: Brass

Finish: /1 /2 /4 /24 /R2

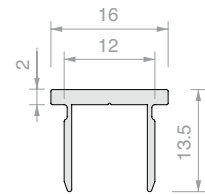

Art.	Length	Qty
<b>LMU86B.100</b>	<b>992 mm</b>	<b>1 Pc</b>
<b>LMU86B.150</b>	<b>1498 mm</b>	<b>1 Pc</b>
<b>LMU86B.300</b>	<b>3000 mm</b>	<b>1 Pc</b>

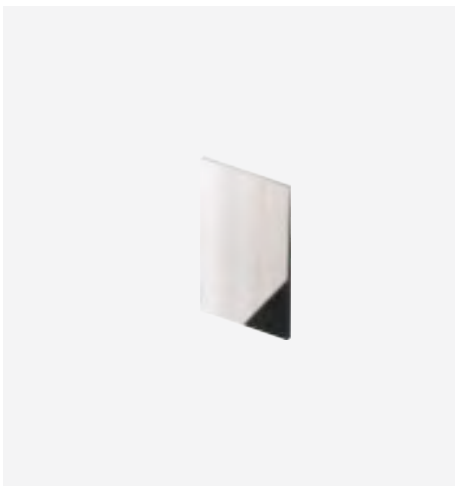

**FLAT CAP LMUB**

Material: Brass

Finish: /1 /2 /4 /24 /R2

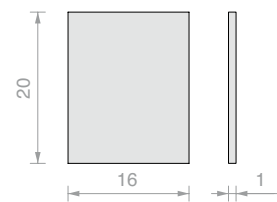

Art.	Qty
<b>LMU20TPB</b>	<b>1 Pc</b>



**WATER BARRIER PROFILE, PESQ0810B**

Material: Brass

Finish: /1 /2 /4 /24 /R2

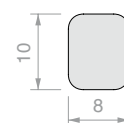

Art.	Length	Qty
<b>PESQ0810B.100</b>	<b>992 mm</b>	<b>1 Pc</b>
<b>PESQ0810B.150</b>	<b>1498 mm</b>	<b>1 Pc</b>
<b>PESQ0810B.300</b>	<b>3000 mm</b>	<b>1 Pc</b>

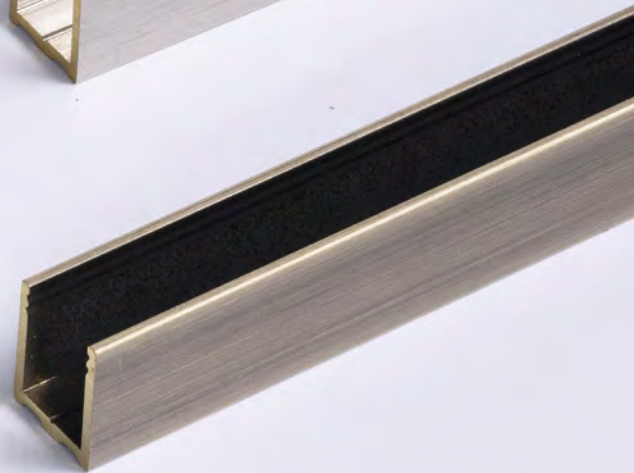
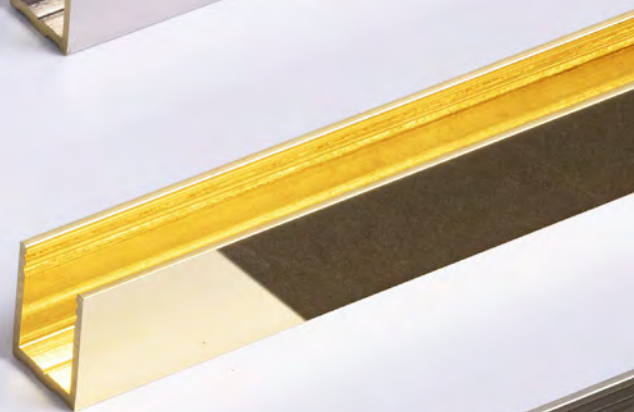
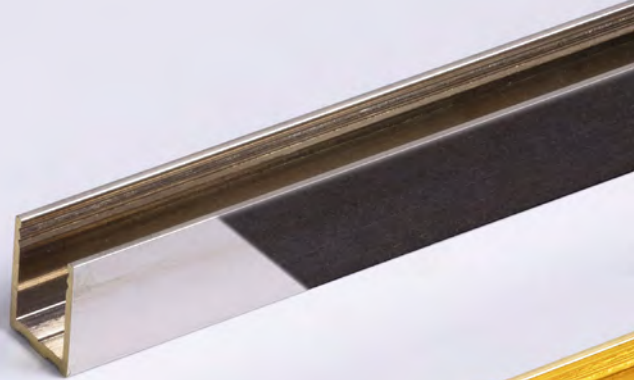
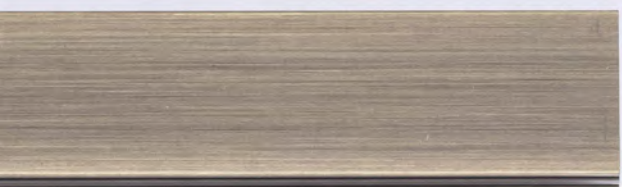
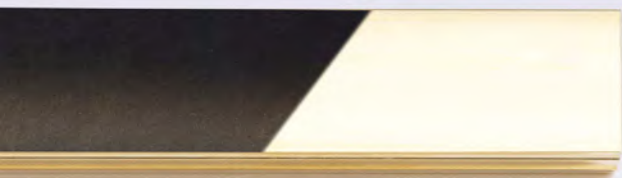



**CENTRAL COLUMN NOVI**

Material: Aluminium

Finish: /6 /91

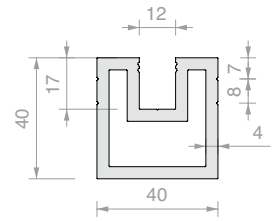

Art.	Length	Qty
<b>NV3100</b>	3000 mm	1 Pc

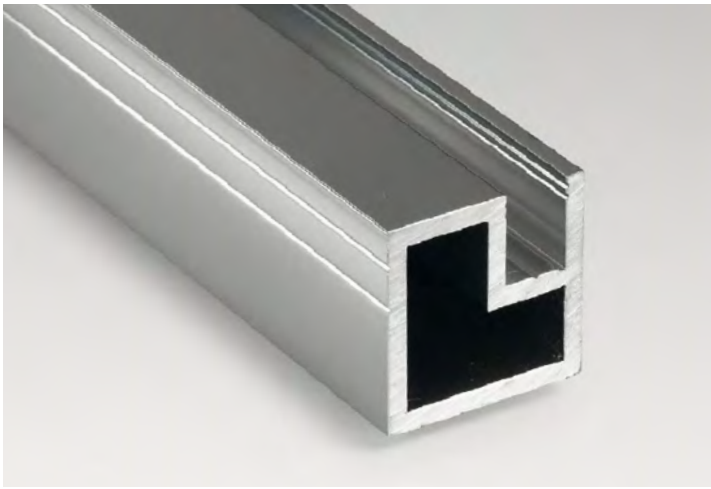

**SIDE COLUMN NOVI**

Material: Aluminium

Finish: /6 /91

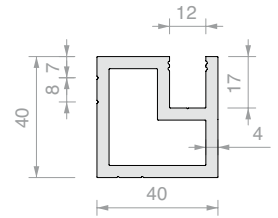

Art.	Length	Qty
<b>NV3300</b>	3000 mm	1 Pc



**UPPER COVER FOR NOVI COLUMN**

Material: Aluminium

Finish: /6 /91

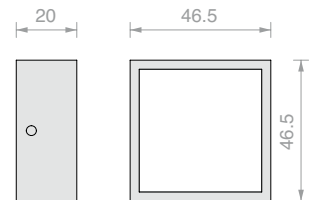

Art.	Qty
<b>NV3500</b>	1 Pc

**LEFT FIXING KIT**

Material: AISI 304 steel

**CENTRAL FIXING KIT**

Material: AISI 304 steel

**RIGHT FIXING KIT**

Material: AISI 304 steel

**3 SELF-DRILLING SCREWS**

Material: AISI 304 steel



Art.	Qty	Art.	Qty	Art.	Qty	Art.	Qty
<b>NV3400SX</b>	1 Pc	<b>NV3200</b>	1 Pc	<b>NV3400DX</b>	1 Pc	<b>NV3600</b>	1 Pc



FIXING ORIENTATION

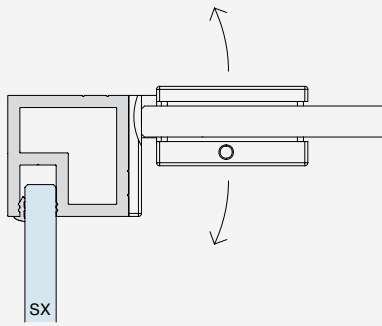

NV3400SX

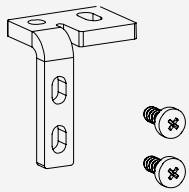

NV3500

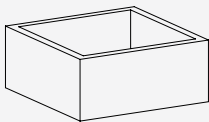

NV3300

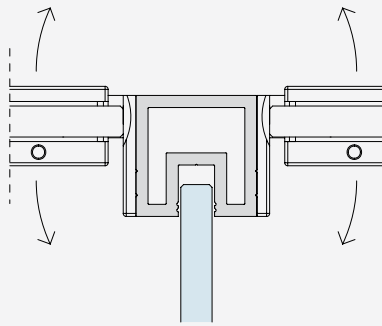
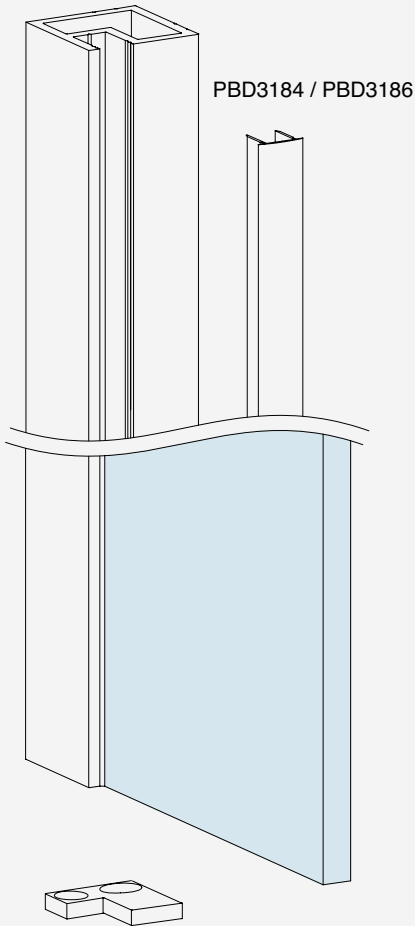

NV3200

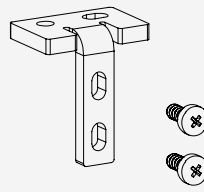

NV3500

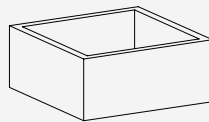

NV3100

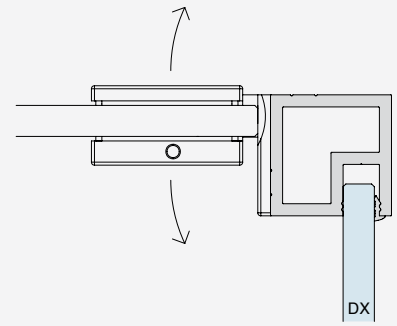
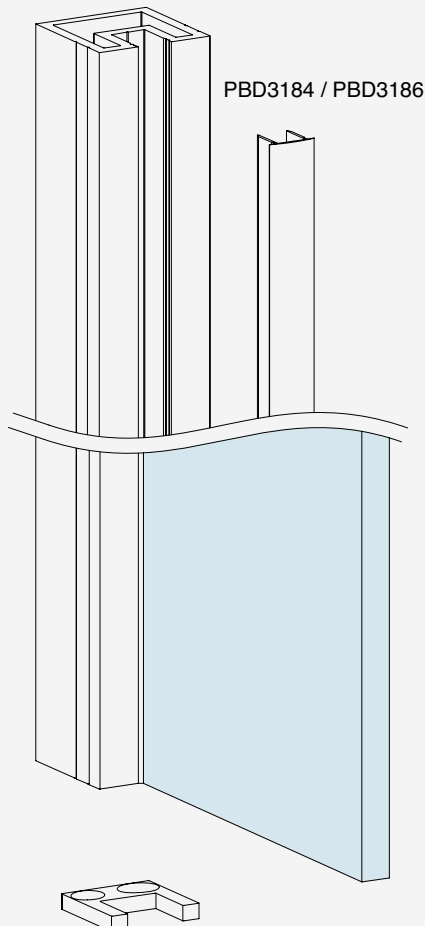

NV3400DX

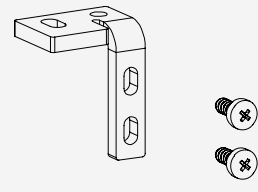

NV3500

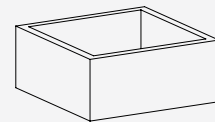

NV3300

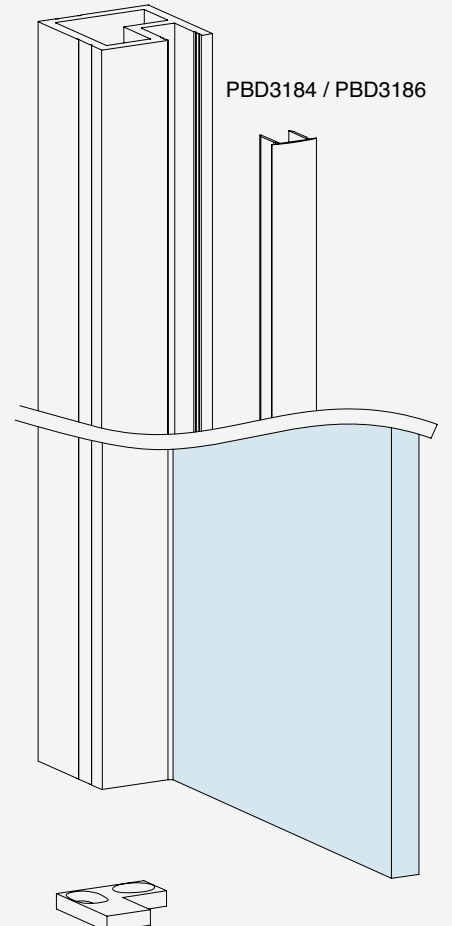



**PBD3183 U-SHAPED PROFILE**

Material: Aluminium

Finish: **/6** /88 /91 /97

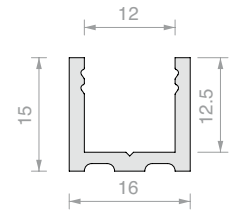

Art.	Length	Qty
<b>PBD3183.150</b>	1498 mm	1 Pc
<b>PBD3183.220</b>	2200 mm	1 Pc
<b>PBD3183</b>	3000 mm	1 Pc



**ROUNDED UPPER PROFILE PBD3184**

Material: Aluminium

Finish: **/6** /88 /91 /97

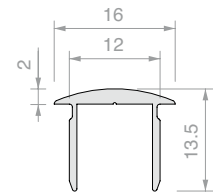

Art.	Length	Qty
<b>PBD3184.100</b>	992 mm	1 Pc
<b>PBD3184.150</b>	1498 mm	1 Pc
<b>PBD3184</b>	3000 mm	1 Pc



**ROUNDED CAP PBD**

Material: Aluminium

Finish: **/6** /88 /91 /97

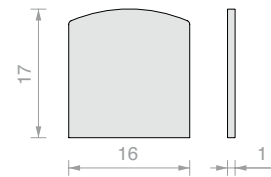

Art.	Qty
<b>PBDTP</b>	1 Pc



**FLAT UPPER PROFILE PBD3186**

Material: Aluminium

Finish: **/6** /88 /91 /97

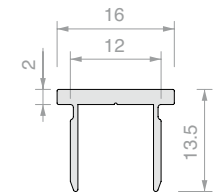

Art.	Length	Qty
<b>PBD3186.100</b>	992 mm	1 Pc
<b>PBD3186.150</b>	1498 mm	1 Pc
<b>PBD3186</b>	3000 mm	1 Pc



**PBD FLAT CAP**

Material: Aluminium

Finish: **/6** /88 /91 /97

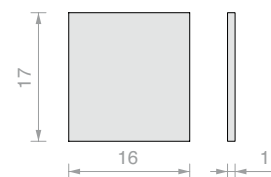

Art.	Qty
<b>PBD86TP</b>	1 Pc



### FLAT PROFILE FORME SERIES

Material: Aluminium

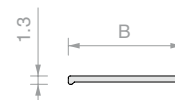
Finish:  /6  /88  /97  /RAL

Art.	B	Length	Qty
<b>FOP10.30</b>	10 mm	3000 mm	1 Pc
<b>FOP15.30</b>	15 mm	3000 mm	1 Pc
<b>FOP20.30</b>	20 mm	3000 mm	1 Pc

### L-SHAPED FLAT PROFILE FORME SERIES

Material: Aluminium

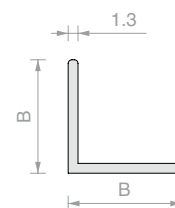
Finish:  /6  /88  /97  /RAL

Art.	B	Length	Qty
<b>FOL1010.30</b>	10 mm	3000 mm	1 Pc
<b>FOL1515.30</b>	15 mm	3000 mm	1 Pc
<b>FOL2020.30</b>	20 mm	3000 mm	1 Pc

### U-SHAPED FLAT PROFILE FORME SERIES

Material: Aluminium

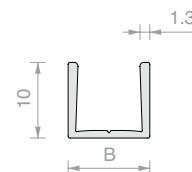
Finish:  /6  /88  /97  /RAL

Art.	B	Length	For glass	Qty
<b>FOU1009.30</b>	8.8 mm	3000 mm	6 mm	1 Pc
<b>FOU1011.30</b>	10.8 mm	3000 mm	8 mm	1 Pc
<b>FOU1013.30</b>	12.8 mm	3000 mm	10 mm	1 Pc



### TESA® ACX<sup>plus</sup> DOUBLE-SIDED TAPE

Transparent double-sided tape for structural fixing of glass, steel and aluminium. The paper liner makes manual application of the tape easier. Solid, high performance backing with excellent viscoelastic properties and high bonding power, dissipation of static and dynamic stresses, plus high resistance to temperatures, humidity, UV rays, and chemical agents. Maximum operating temperature 100°C; peak temperature 200°C (max. 20 minutes). Recommended for glass/glass and glass/metal bonding: ideal for compensating different thermal expansions without losing strength. To achieve the best performance, it is recommended to prepare the application surfaces using the specific adhesion promoter, Art. TS100

Art.	Dimensions	Thickness	Qty
<b>TS250065</b>	6 mm x 25 m	0.5 mm	1 Pc
<b>TS25006</b>	6 mm x 25 m	1 mm	1 Pc
<b>TS25009</b>	9 mm x 25 m	1 mm	1 Pc
<b>TS250125</b>	12 mm x 25 m	0.5 mm	1 Pc
<b>TS25012</b>	12 mm x 25 m	1 mm	1 Pc
<b>TS250155</b>	15 mm x 25 m	0.5 mm	1 Pc
<b>TS25019</b>	19 mm x 25 m	1 mm	1 Pc



**BALLOON GASKET**

Material: Co-extruded rigid and soft PVC  
 Resistant to UV rays  
 Fungicide to prevent mould from forming  
 Maximum operating temperature 70°C  
 Colour: transparent, transparent balloon

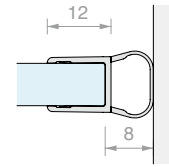

Art.	Length	For glass	Qty
<b>GM62</b>	2200 mm	From 6 to 8 mm	1 Pc
<b>GM6225</b>	2500 mm	From 6 to 8 mm	1 Pc
<b>GM6230</b>	3000 mm	From 6 to 8 mm	1 Pc

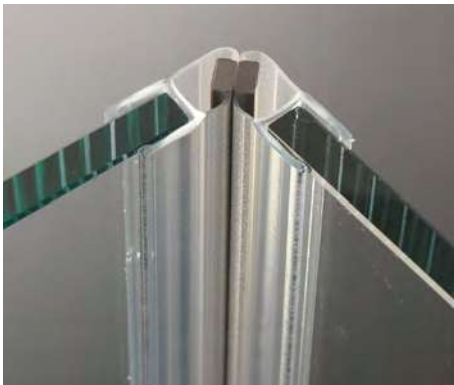

**MAGNETIC 45° GASKET**

Material: Co-extruded rigid and soft PVC  
 Maximum operating temperature 70°C  
 Colour: transparent, embossed balloon, grey magnet

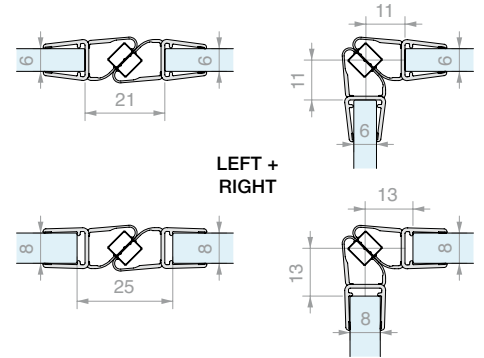

Art.	Length	For glass	Qty
<b>GM12DX20</b>	2000 mm	From 6 to 8 mm	1 Pc
<b>GM12DX22</b>	2200 mm	From 6 to 8 mm	1 Pc
<b>GM12DX25</b>	2500 mm	From 6 to 8 mm	1 Pc
<b>GM12SX20</b>	2000 mm	From 6 to 8 mm	1 Pc
<b>GM12SX22</b>	2200 mm	From 6 to 8 mm	1 Pc
<b>GM12SX25</b>	2500 mm	From 6 to 8 mm	1 Pc



**90° STRIKE JAMB GASKET**

Material: Co-extruded rigid and soft PVC  
 Resistant to UV rays  
 Fungicide to prevent mould from forming  
 Maximum operating temperature 70°C  
 Colour: transparent/\*black, embossed lip

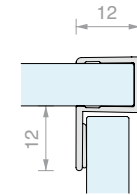

Art.	Length	For glass	Qty
<b>GM58</b>	2200 mm	From 6 to 8 mm	1 Pc
<b>GM58NR*</b>	2200 mm	From 6 to 8 mm	1 Pc
<b>GM5830</b>	3000 mm	From 6 to 8 mm	1 Pc

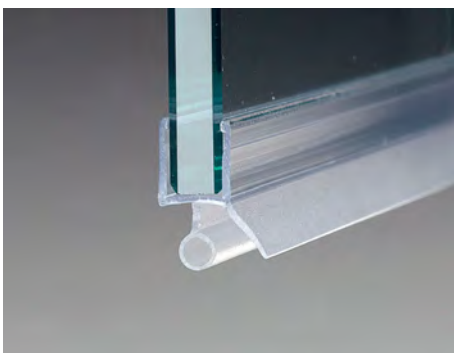

**GASKET WITH BALLOON WATER BARRIER AND DRIP FLAP**

Material: Co-extruded rigid and soft PVC  
 Resistant to UV rays  
 Fungicide to prevent mould from forming  
 Maximum operating temperature 70°C  
 Colour: transparent, embossed lip and balloon

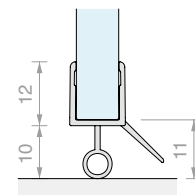

Art.	Length	For glass	Qty
<b>GM6010</b>	1000 mm	From 6 to 8 mm	1 Pc
<b>GM6020</b>	2000 mm	From 6 to 8 mm	1 Pc
<b>GM6025</b>	2500 mm	From 6 to 8 mm	1 Pc
<b>GM6030</b>	3000 mm	From 6 to 8 mm	1 Pc

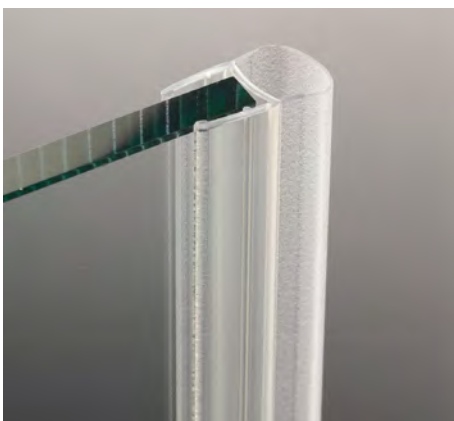

**BALLOON GASKET**

Material: Co-extruded rigid and soft PVC  
 Resistant to UV rays  
 Fungicide to prevent mould from forming  
 Colour: transparent/\*black, embossed balloon

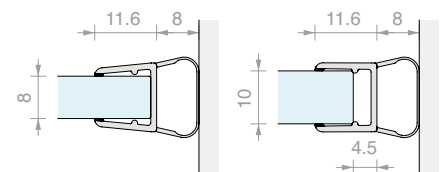

Art.	Length	For glass	Qty
<b>GM06</b>	2000 mm	From 8 to 10 mm	1 Pc
<b>GM0622</b>	2200 mm	From 8 to 10 mm	1 Pc
<b>GM0622NR*</b>	2200 mm	From 8 to 10 mm	1 Pc
<b>GM0625</b>	2500 mm	From 8 to 10 mm	1 Pc
<b>GM0625NR*</b>	2500 mm	From 8 to 10 mm	1 Pc
<b>GM063000</b>	3000 mm	From 8 to 10 mm	1 Pc
<b>GM063000NR*</b>	3000 mm	From 8 to 10 mm	1 Pc



### MAGNETIC 45° GASKET

Material: Co-extruded rigid and soft PVC  
Resistant to UV rays  
Fungicide to prevent mould from forming  
Maximum operating temperature 70°C  
Colour: transparent/\*black, transparent balloon, white/\*black magnet

Art.	Length	For glass	Qty
<b>GM1520SX</b>	2200 mm	From 8 to 10 mm	1 Pc
<b>GM1520SXNR*</b>	2200 mm	From 8 to 10 mm	1 Pc
<b>GM1520DX</b>	2200 mm	From 8 to 10 mm	1 Pc
<b>GM1520DXNR*</b>	2200 mm	From 8 to 10 mm	1 Pc
<b>GM15SX</b>	2500 mm	From 8 to 10 mm	1 Pc
<b>GM15DX</b>	2500 mm	From 8 to 10 mm	1 Pc
<b>GM1530SX</b>	3000 mm	From 8 to 10 mm	1 Pc
<b>GM1530DX</b>	3000 mm	From 8 to 10 mm	1 Pc

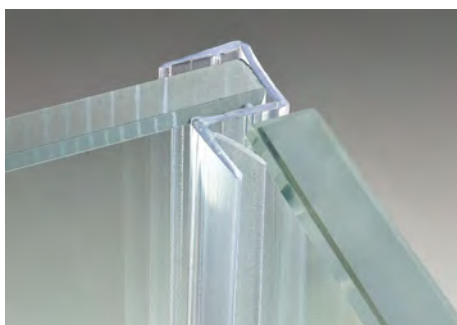
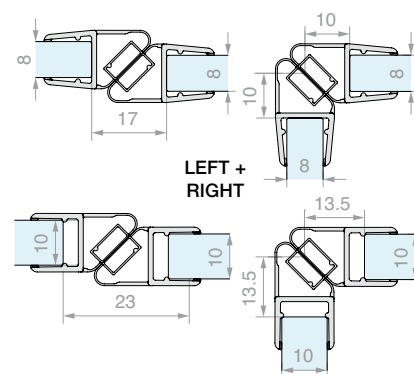

### 90° STRIKE JAMB GASKET

Material: Co-extruded rigid and soft PVC  
Resistant to UV rays  
Fungicide to prevent mould from forming  
Maximum operating temperature 70°C  
Colour: transparent, embossed lip

Art.	Length	For glass	Qty
<b>GM5422</b>	2200 mm	From 8 to 10 mm	1 Pc
<b>GM5430</b>	3000 mm	From 8 to 10 mm	1 Pc

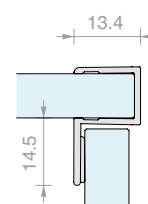

### GASKET WITH LIP WATER BARRIER AND DRIP FLAP

Material: Co-extruded rigid and soft PVC  
Resistant to UV rays  
Fungicide to prevent mould from forming  
Maximum operating temperature 70°C  
Colour: transparent/\*black, embossed lip

Art.	Length	For glass	Qty
<b>GM0210</b>	1000 mm	From 8 to 10 mm	1 Pc
<b>GM02</b>	2000 mm	From 8 to 10 mm	1 Pc
<b>GM02NR*</b>	2000 mm	From 8 to 10 mm	1 Pc
<b>GM022500</b>	2500 mm	From 8 to 10 mm	1 Pc
<b>GM022500NR*</b>	2500 mm	From 8 to 10 mm	1 Pc

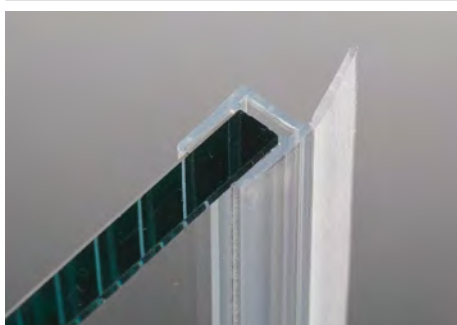
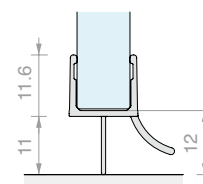

### GASKET WITH STRAIGHT LIP

Material: Co-extruded rigid and soft PVC  
Fungicide to prevent mould from forming  
Colour: transparent, embossed lip

Art.	Length	For glass	Qty
<b>GM04</b>	2000 mm	From 8 to 10 mm	1 Pc
<b>GM0422</b>	2200 mm	From 8 to 10 mm	1 Pc
<b>GM0425</b>	2500 mm	From 8 to 10 mm	1 Pc
<b>GM0430</b>	3000 mm	From 8 to 10 mm	1 Pc

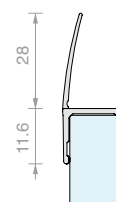

### GLASS HOLDER GASKET

Material: PVC

Art.	Thickness	Colour	Qty	Art.	Thickness	Colour	Qty
<b>GTUP2</b>	2	Transparent	1 m	<b>GTUP5G</b>	5	Embossed	1 m
<b>GTUP3</b>	3	Transparent	1 m	<b>GTUP6G</b>	6	Embossed	1 m
<b>GTUP4</b>	4	Transparent	1 m	<b>GTUP2N</b>	2	Black	1 m
<b>GTUP5</b>	5	Transparent	1 m	<b>GTUP3N</b>	3	Black	1 m
<b>GTUP6</b>	6	Transparent	1 m	<b>GTUP4N</b>	4	Black	1 m
<b>GTUP2G</b>	2	Embossed	1 m	<b>GTUP5N</b>	5	Black	1 m
<b>GTUP3G</b>	3	Embossed	1 m	<b>GTUP6N</b>	6	Black	1 m
<b>GTUP4G</b>	4	Embossed	1 m				

# CHD

## *Design*

The soft lines and mechanical technology make products in the CHD series perfect for any type of furnishings.

TÜV certification and the available finishes are quickly able to meet the most particular requests.

Suitable for glass thicknesses from 6 to 10 mm, the CHD series offers standard configurations as well as numerous opportunities for customisation due to different combinations of hinges, locks, knobs, clamps, and stabilizer bars.

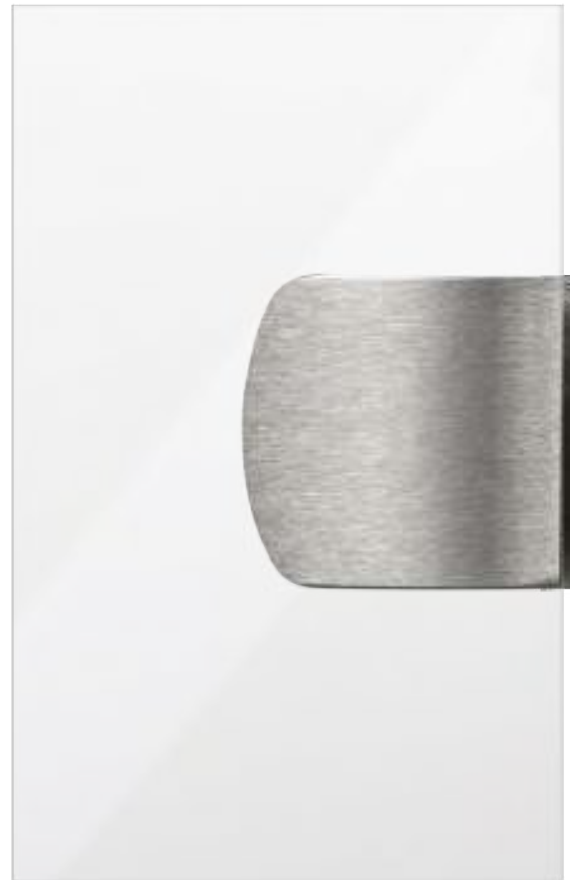
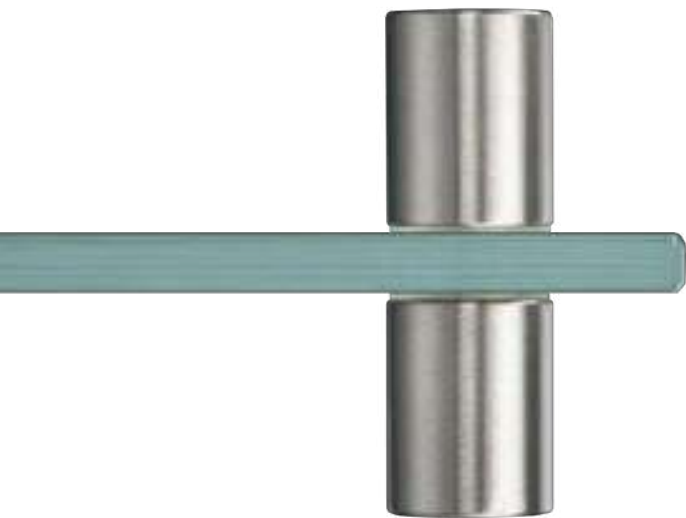



**/1**  
Chrome

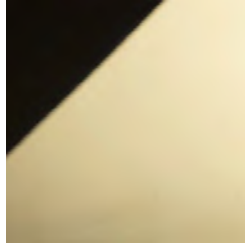

**/2**  
Gold



**/4**  
Bronze

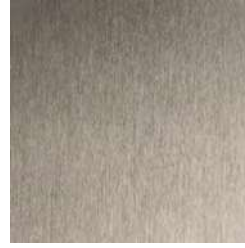

**/24**  
Brushed steel effect



**/R2**  
RAL9005 matt black



# CHD

## CHD Hinges

CHD hinges are the functional heart of the CHD series.

The hinge body is made of cast brass, while the components are mechanically processed.

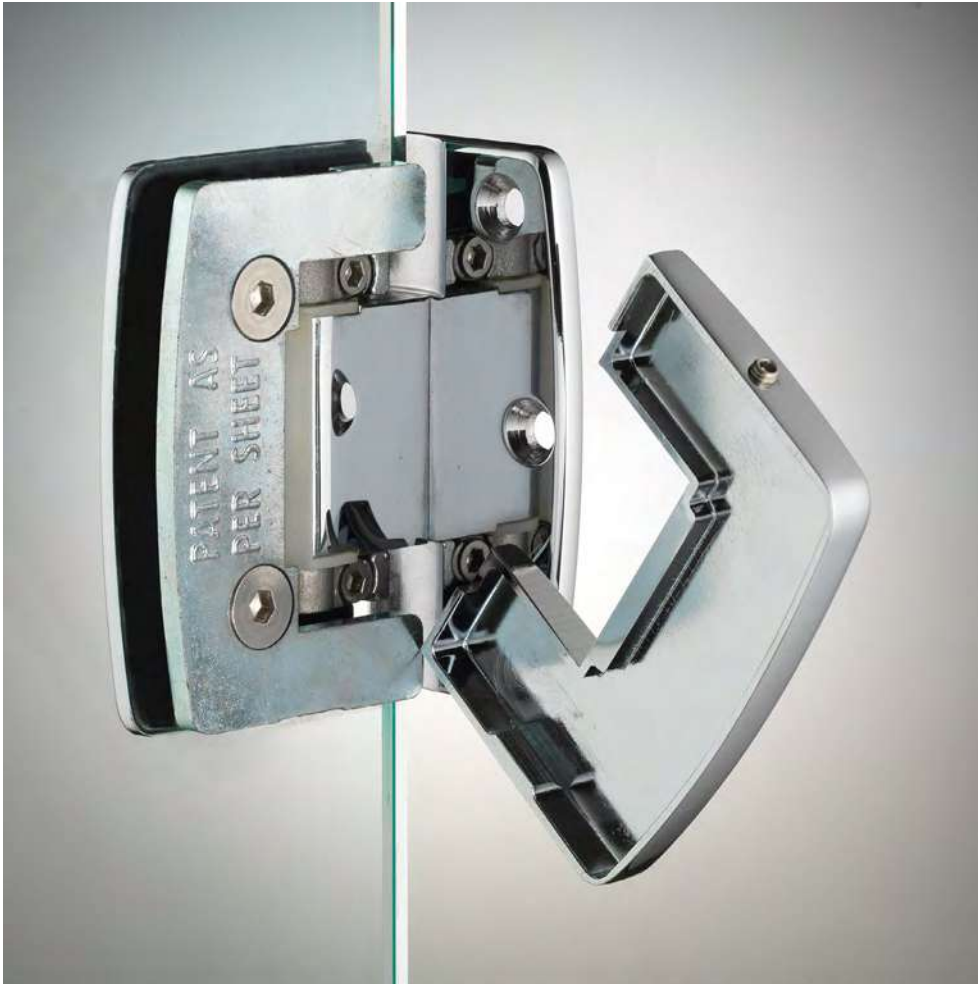

Cap on one side to cover the screws fixing the hinge on the glass.



Adhesive seals to facilitate positioning of the hinge on the glass.

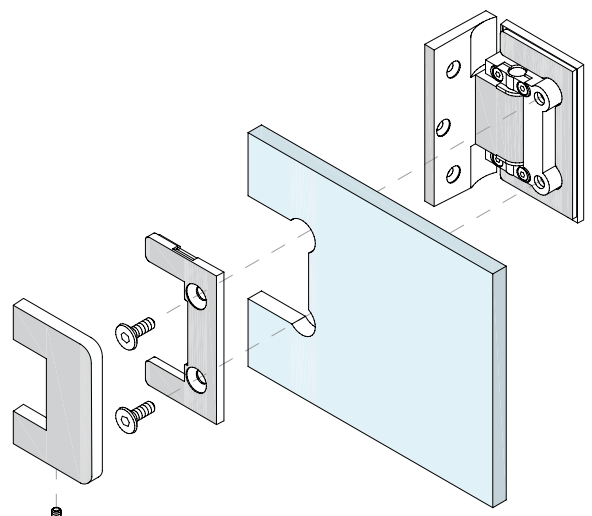



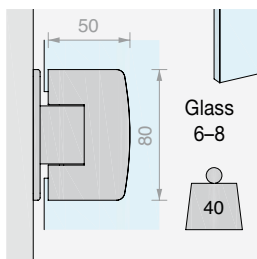
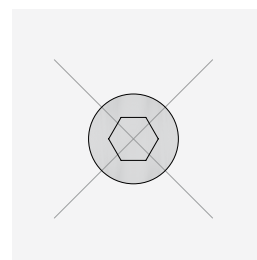
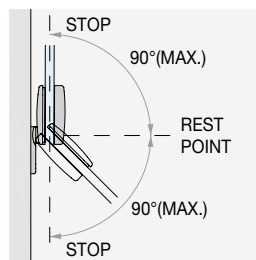
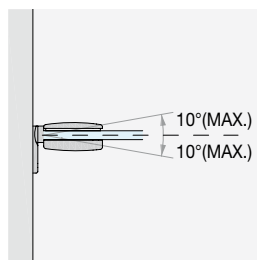
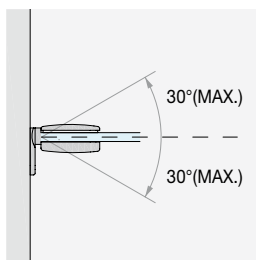
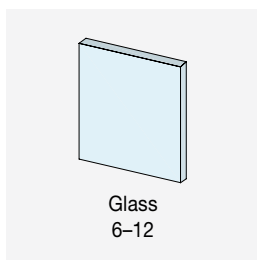

**CLOSING RETURN**  
Automatic return to the zero position in the last 30°.

**CORRECTION 10°**  
Correction of the door angle  $\pm 10^\circ$  upon installation.

**ANGLE OF ROTATION**  
Angle of rotation from  $+90^\circ$  to  $-90^\circ$ .  
With rest point at  $0^\circ$  and stops at  $-90^\circ$  and  $+90^\circ$ .

**NO VISIBLE SCREWS**

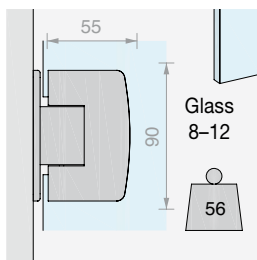

**TWO VERSIONS FOR GLASS WITH THICKNESS FROM 6 TO 12 mm**

The CHD SERIES can be used for glass with thickness from 6 to 12 mm thanks to hinges and locks in two versions, small and large. Depending on the chosen glass, it is possible to select the related hinge

Adhesive finishing screw-cover cap

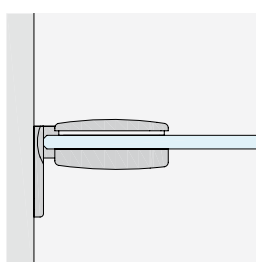

**WALL/GLASS**  
with side plate

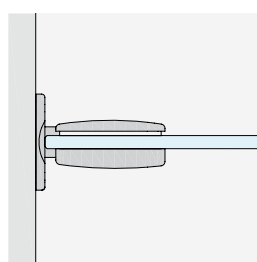

**WALL/GLASS**  
with central plate

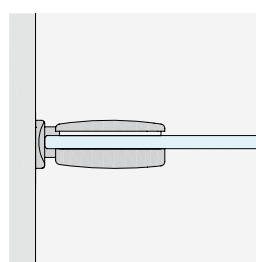

**WALL/GLASS**  
for narrow jambs

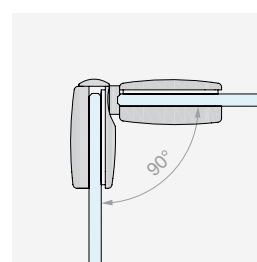

**GLASS/GLASS**  
90° corner

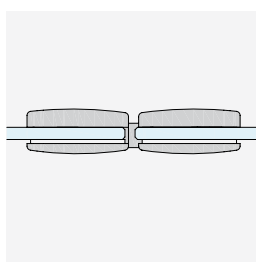

**GLASS/GLASS**  
in-line

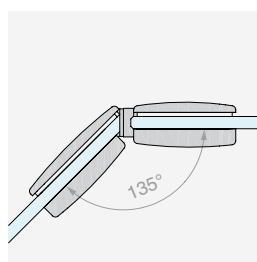

**GLASS/GLASS**  
135°



## CONFIGURATIONS WITH HINGED DOORS

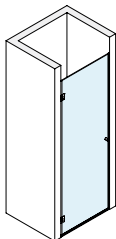

Page 253

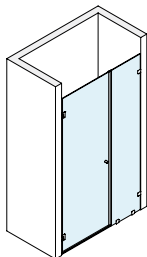

Page 257

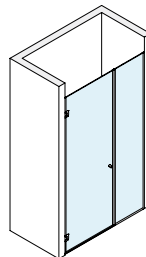

Page 261

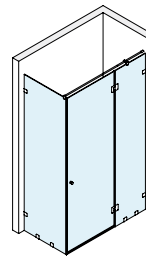

Page 265

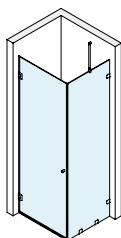

Page 269

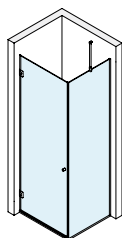

Page 273

## WALK-IN CONFIGURATIONS

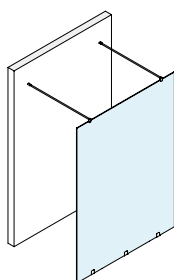

Page 277

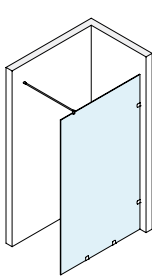

Page 279



**WALL/WALL HINGED  
SHOWER KIT**

Finish: /1 /2 /4 /24 /R2

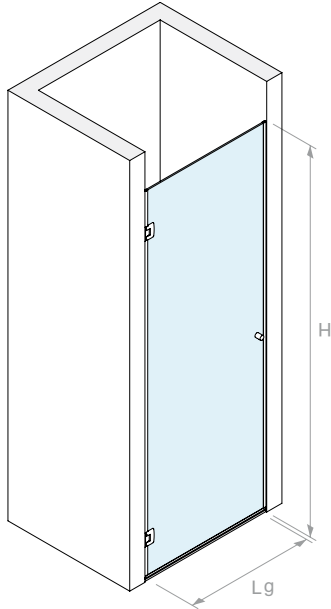

VERSION WITH HINGE **CHD10COV** 50 mm x 80 mm

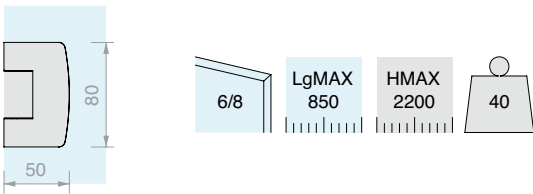

Kit comprising:

Art.	Description	Qty.
<b>CHD10COV</b>	Adjustable side hinge	2 Pcs
<b>PESQ0810B.100</b>	Water barrier profile	1 Pc
<b>GM6010</b>	Gasket with drip flap	1 Pc
<b>GM62</b>	Balloon gasket	2 Pcs
<b>SP2255</b>	Pair of knobs	1 Pc

VERSION WITH HINGE **CHD20COV** 55 mm x 90 mm

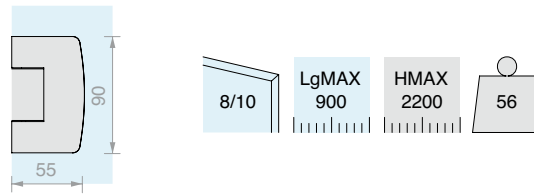

Kit comprising:

Art.	Description	Qty.
<b>CHD20COV</b>	Adjustable side hinge	2 Pcs
<b>PESQ0810B.100</b>	Water barrier profile	1 Pc
<b>GM0210</b>	Gasket with drip flap	1 Pc
<b>GM0622</b>	Balloon gasket	2 Pcs
<b>SP2255</b>	Pair of knobs	1 Pc

Art. **BDCHD6801** Qty 1 Pc

Art. **BDCHD81001** Qty 1 Pc

GLASS PANE DIMENSIONS

BDCHD6801

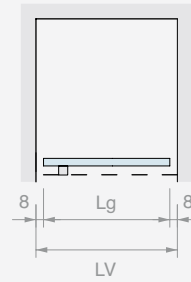
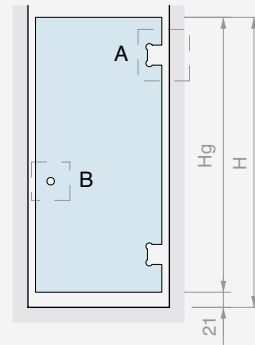
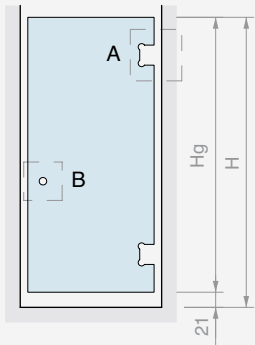

$H_g = H - 21$   
 $L_g \text{ (MAX 850)} = LV - 16$

$H_g = H - 21$   
 $L_g \text{ (MAX 850)} = LV - 16$

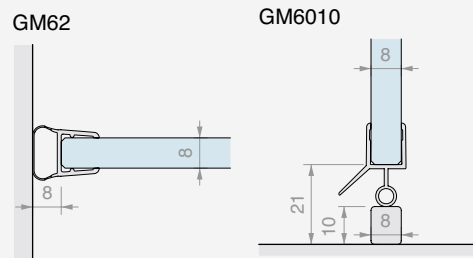
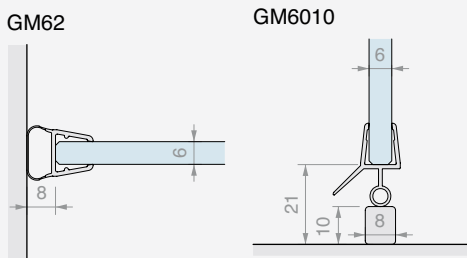
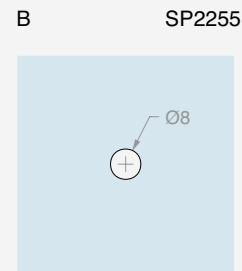
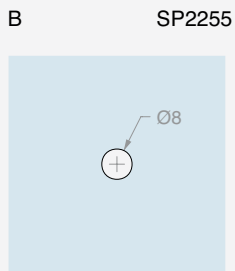
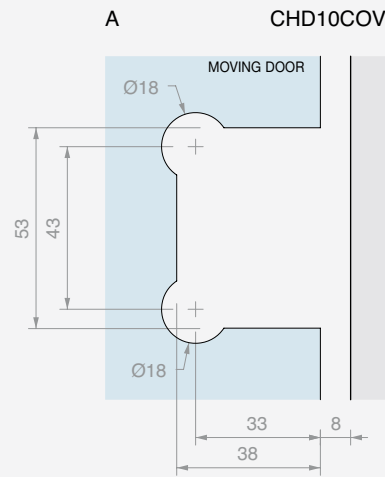
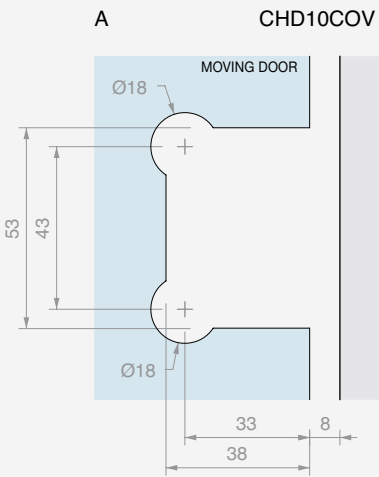

GLASS PANE DIMENSIONS

BDCHD81001

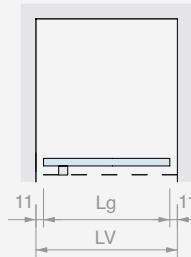
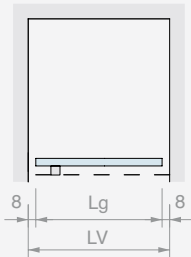
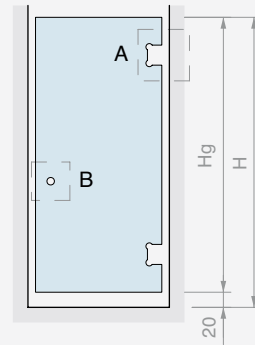
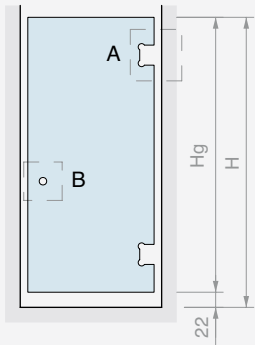

$H_g = H - 22$   
 $L_g (\text{MAX } 900) = LV - 16$

$H_g = H - 20$   
 $L_g (\text{MAX } 900) = LV - 23$

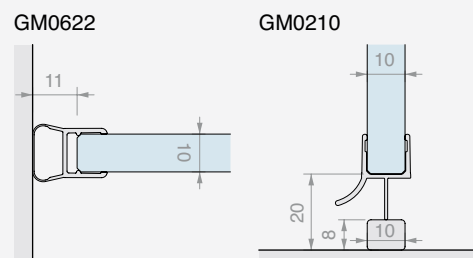
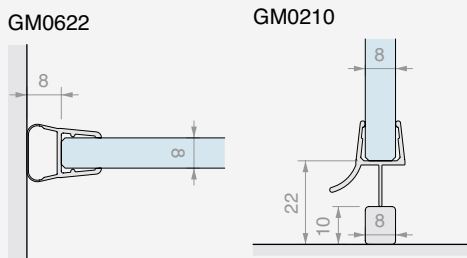
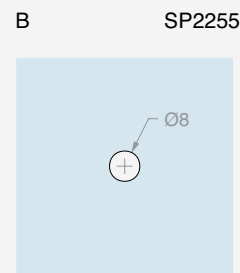
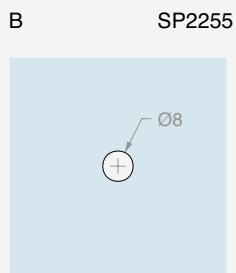
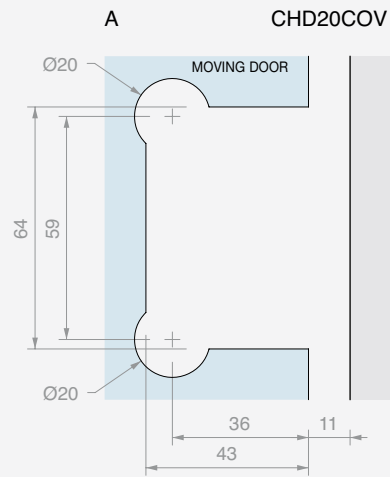
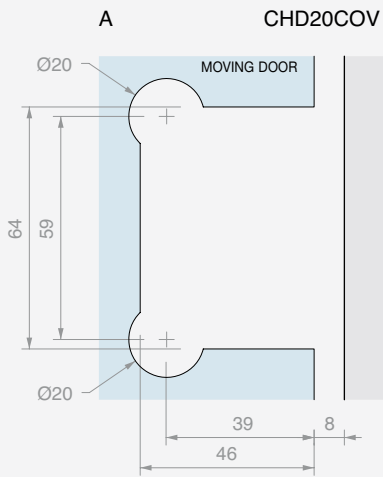





**WALL/WALL HINGED SHOWER KIT WITH FIXED PANE AND CLAMPS**



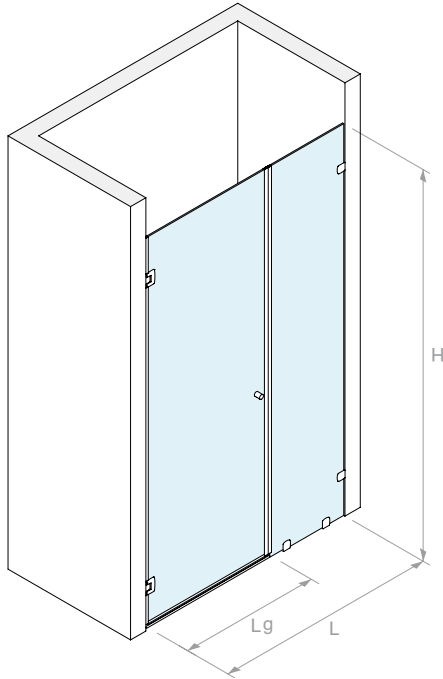



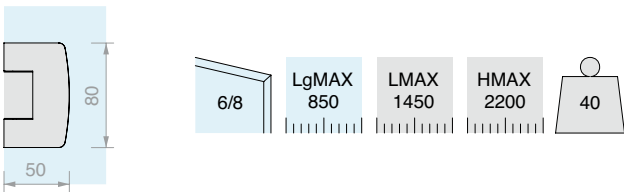



Finish:     



VERSION WITH HINGE **CHD10COV** 50 mm x 80 mm









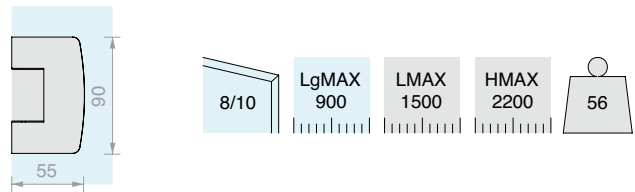



Kit comprising:

Art.	Description	Qty.	
<b>CHD10COV</b>	Adjustable side hinge	2 Pcs	
<b>PESQ0810B.100</b>	Water barrier profile	1 Pc	
<b>GM6010</b>	Gasket with drip flap	1 Pc	
<b>GM12SX22</b>	Magnetic 45° gasket	1 Pc	
<b>GM12DX22</b>	Magnetic 45° gasket	1 Pc	
<b>GM62</b>	Balloon gasket	1 Pc	
<b>SP2255</b>	Pair of knobs	1 Pc	
<b>CHDM41</b>	Clamp flush to the wall	4 Pcs	
Optional			
<b>CHDA55</b>	Jointed stabilizer bar	1 Pc	

VERSION WITH HINGE **CHD20COV** 55 mm x 90 mm



Kit comprising:

Art.	Description	Qty.	
<b>CHD20COV</b>	Adjustable side hinge	2 Pcs	
<b>PESQ0810B.100</b>	Water barrier profile	1 Pc	
<b>GM0210</b>	Gasket with drip flap	1 Pc	
<b>GM1520SX</b>	Magnetic 45° gasket	1 Pc	
<b>GM1520DX</b>	Magnetic 45° gasket	1 Pc	
<b>GM0622</b>	Balloon gasket	1 Pc	
<b>SP2255</b>	Pair of knobs	1 Pc	
<b>CHDM41</b>	Clamp flush to the wall	4 Pcs	
Optional			
<b>CHDA55G</b>	Jointed stabilizer bar	1 Pc	

Art.	Qty
<b>BDCHD6803</b>	1 Pc

Art.	Qty
<b>BDCHD81003</b>	1 Pc

GLASS PANE DIMENSIONS

BDCHD6803

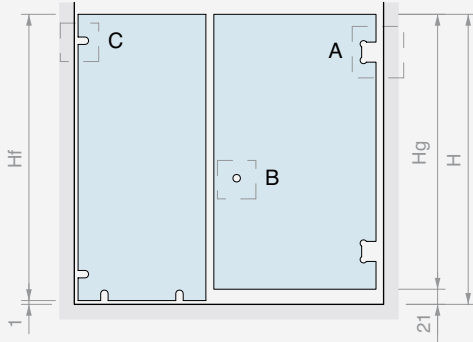

Hf = H - 1  
 Hg = H - 21  
 Lg MAX 850  
 Lf (MAX 600) =  
 LV - Lg - 30

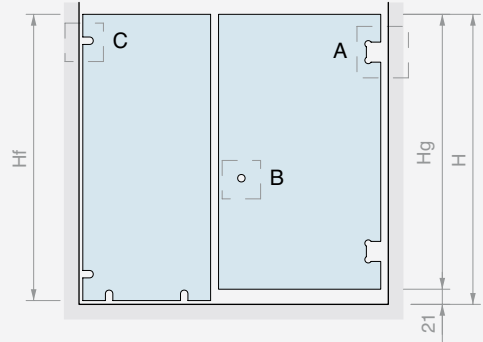
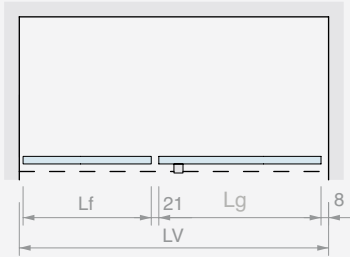

Hf = H - 1  
 Hg = H - 21  
 Lg MAX 850  
 Lf (MAX 600) =  
 LV - Lg - 34

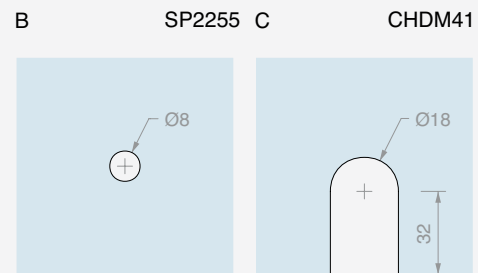
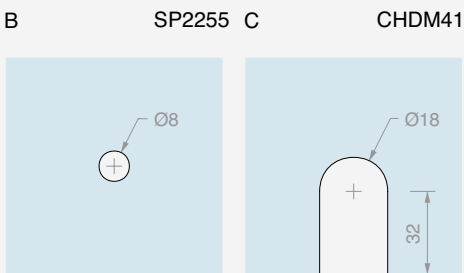
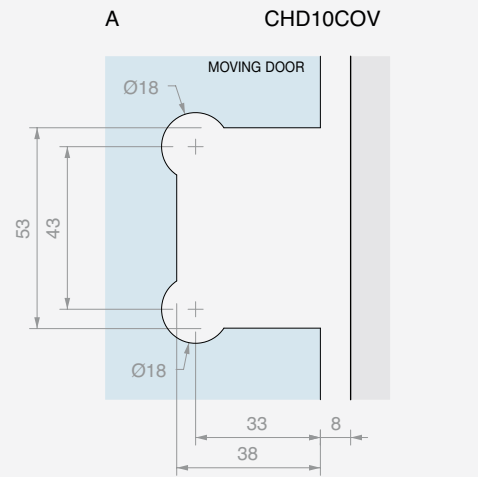
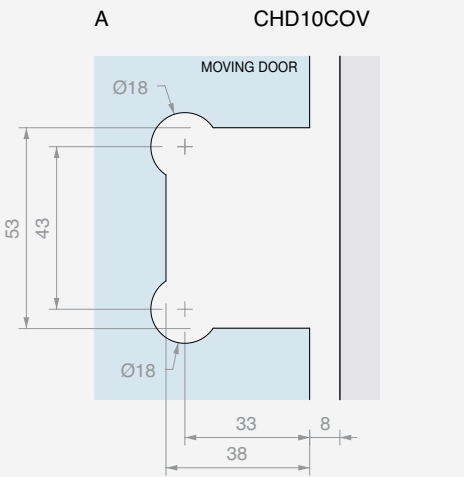
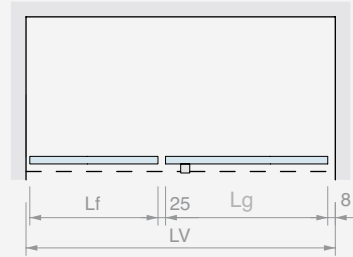

GM12SX22  
 GM12DX22

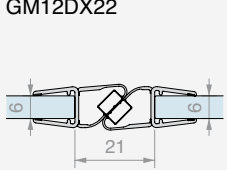

GM6010

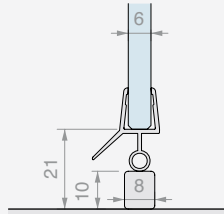

GM62

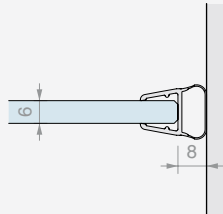

GM12SX22  
 GM12DX22

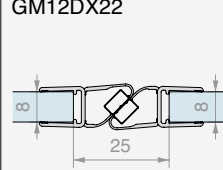

GM6010

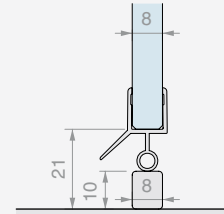

GM62

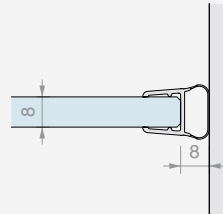

GLASS PANE DIMENSIONS

BDCHD81003

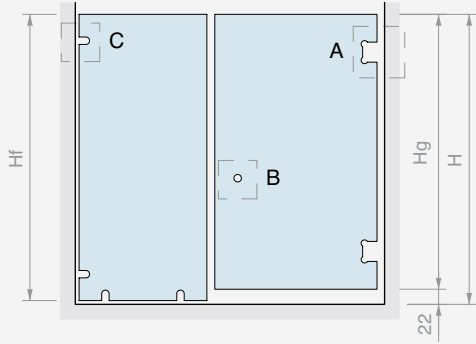

$H_f = H - 1$   
 $H_g = H - 22$   
 $L_g \text{ MAX } 900$   
 $L_f (\text{MAX } 800) =$   
 $LV - L_g - 26$

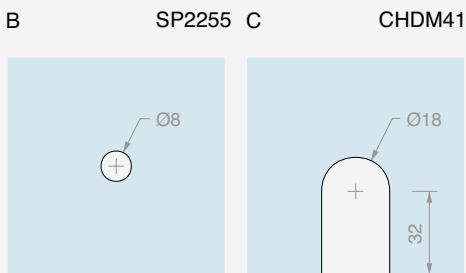
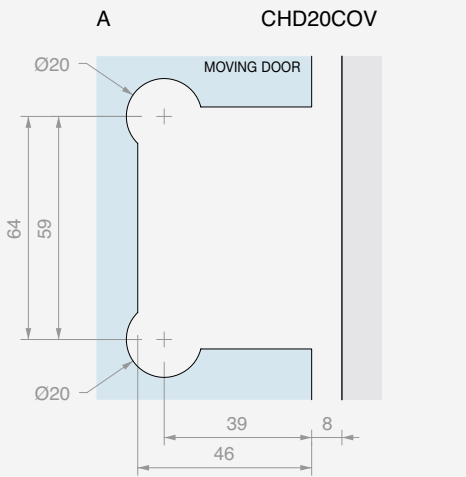
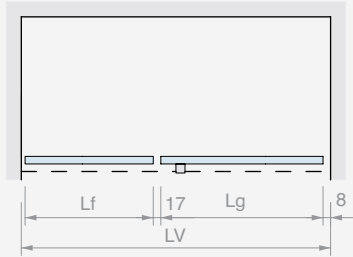

GM1520SX  
GM1520DX

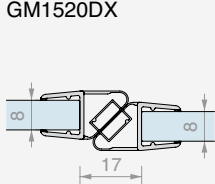

GM0210

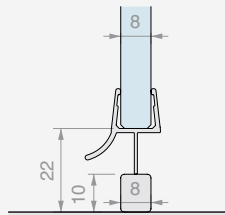

GM0622

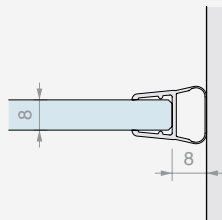

GM1520SX  
GM1520DX

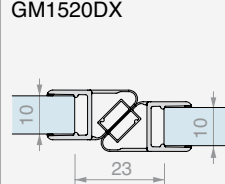

GM0210

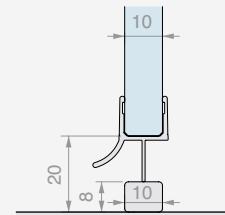

GM0622

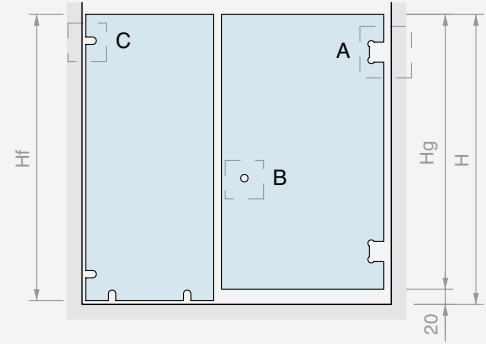
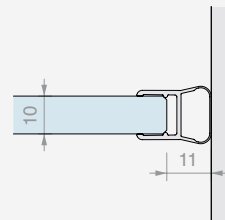

$H_f = H - 1$   
 $H_g = H - 20$   
 $L_g \text{ MAX } 900$   
 $L_f (\text{MAX } 800) =$   
 $LV - L_g - 35$

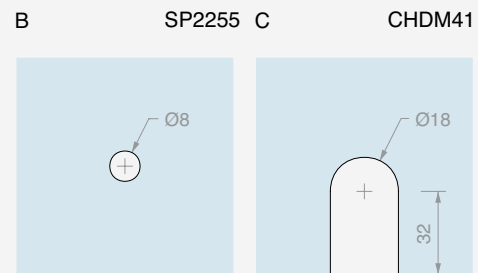
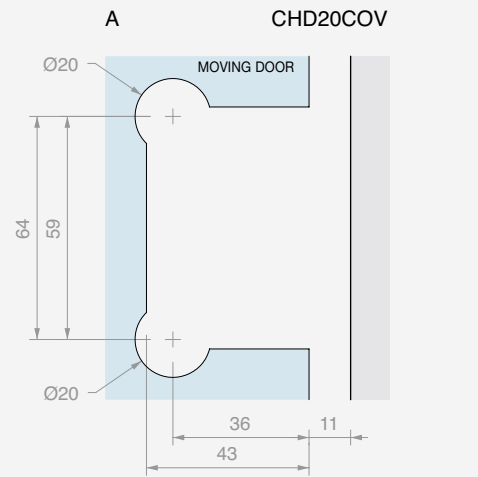
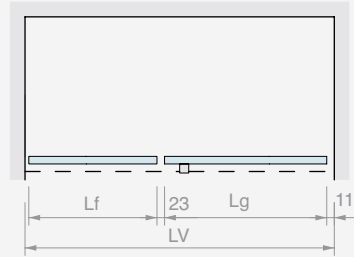



**WALL/WALL HINGED SHOWER KIT WITH FIXED PANE AND PROFILES**



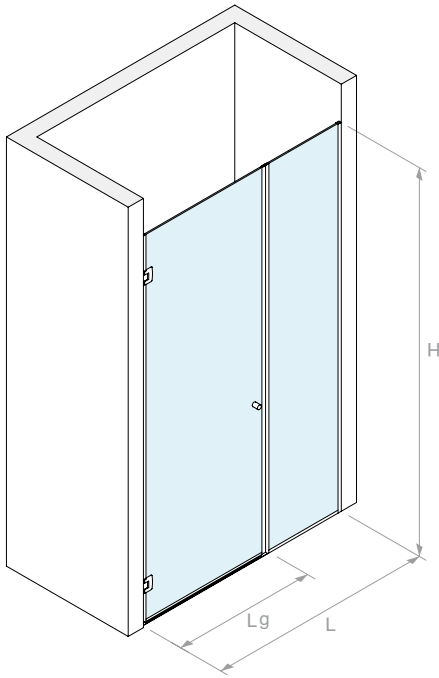



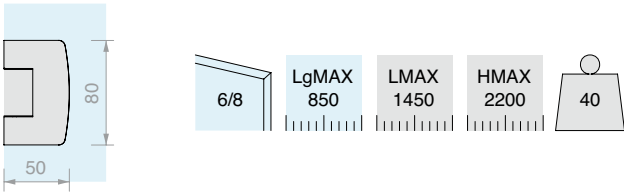





Finish: 



VERSION WITH HINGE **CHD10COV** 50 mm x 80 mm



Kit comprising:

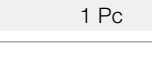





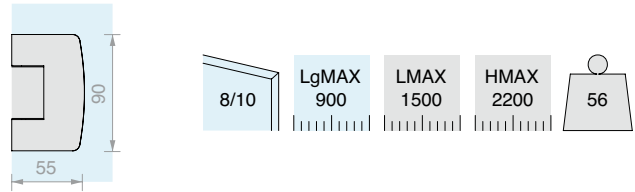



Art.	Description	Qty.	
<b>CHD10COV</b>	Adjustable side hinge	2 Pcs	
<b>LMU20B.220</b>	U-shaped profile	1 Pc	
<b>LMU20B.150</b>	U-shaped profile	1 Pc	
<b>LMU86B.100</b>	Flat upper profile	1 Pc	
<b>GTUP4</b>	Glass holder gasket	4 m	
<b>GTUP6</b>	Glass holder gasket	4 m	
<b>GM6010</b>	Gasket with drip flap	1 Pc	
<b>GM12SX22</b>	Magnetic 45° gasket	1 Pc	
<b>GM12DX22</b>	Magnetic 45° gasket	1 Pc	
<b>GM62</b>	Balloon gasket	1 Pc	
<b>SP2255</b>	Pair of knobs	1 Pc	
Optional			
<b>CHDA55</b>	Jointed stabilizer bar	1 Pc	

Art. **BDCHD6805** Qty 1 Pc

VERSION WITH HINGE **CHD20COV** 55 mm x 90 mm

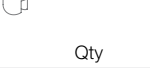
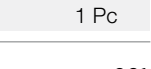

Kit comprising:

Art.	Description	Qty.	
<b>CHD20COV</b>	Adjustable side hinge	2 Pcs	
<b>LMU20B.220</b>	U-shaped profile	1 Pc	
<b>LMU20B.150</b>	U-shaped profile	1 Pc	
<b>LMU86B.100</b>	Flat upper profile	1 Pc	
<b>GTUP4</b>	Glass holder gasket	4 m	
<b>GTUP2</b>	Glass holder gasket	4 m	
<b>GM0210</b>	Gasket with drip flap	1 Pc	
<b>GM1520SX</b>	Magnetic 45° gasket	1 Pc	
<b>GM1520DX</b>	Magnetic 45° gasket	1 Pc	
<b>GM0622</b>	Balloon gasket	1 Pc	
<b>SP2255</b>	Pair of knobs	1 Pc	
Optional			
<b>CHDA55G</b>	Jointed stabilizer bar	1 Pc	

Art. **BDCHD81005** Qty 1 Pc

GLASS PANE DIMENSIONS

BDCHD6805

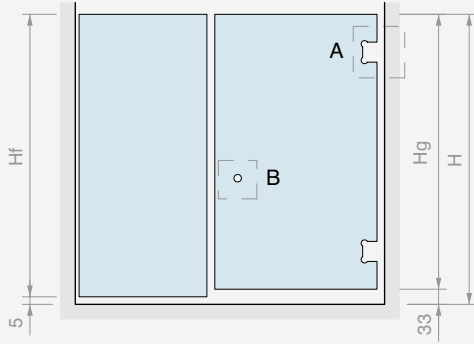

$H_f = H - 5$   
 $H_g = H - 33$   
 $L_g \text{ MAX } 850$   
 $L_f \text{ (MAX } 600) =$   
 $LV - L_g - 34$

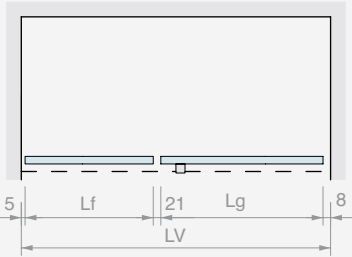

A CHD10COV

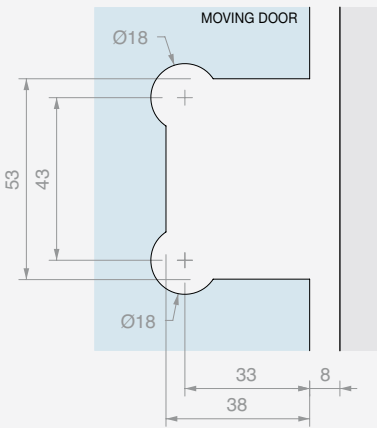

B SP2255

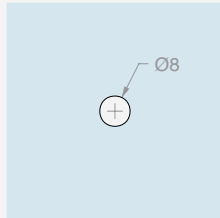

GM12SX22  
GM12DX22

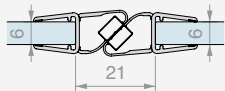

GM6010

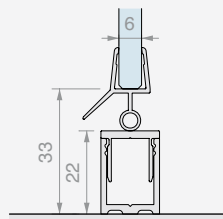

GM62

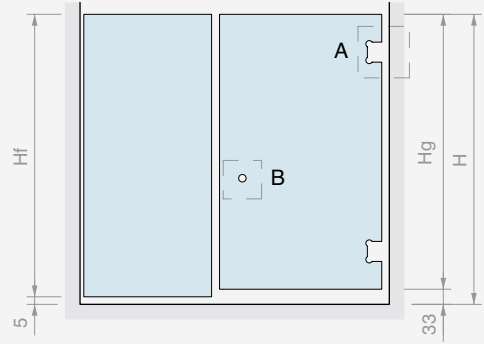
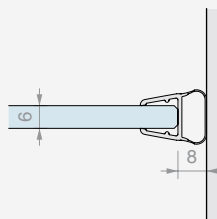

$H_f = H - 5$   
 $H_g = H - 33$   
 $L_g \text{ MAX } 850$   
 $L_f \text{ (MAX } 600) =$   
 $LV - L_g - 38$

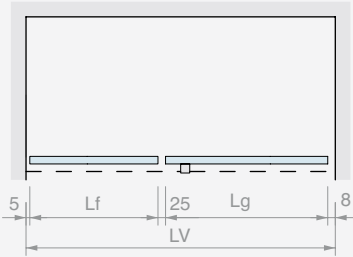

A CHD10COV

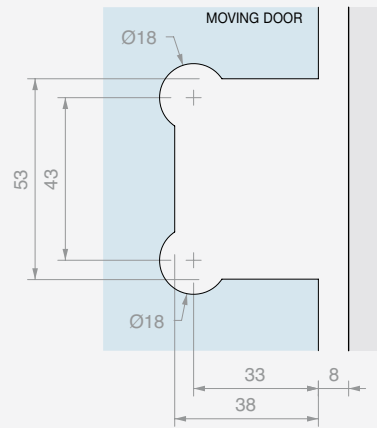

B SP2255

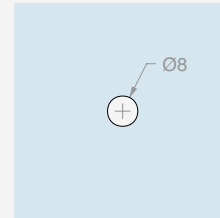

GM12SX22  
GM12DX22

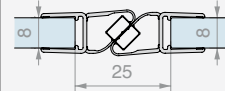

GM6010

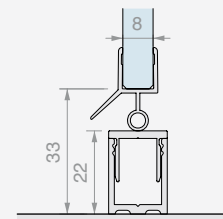

GM62

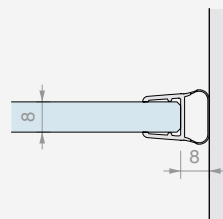

GLASS PANE DIMENSIONS

BDCHD81005

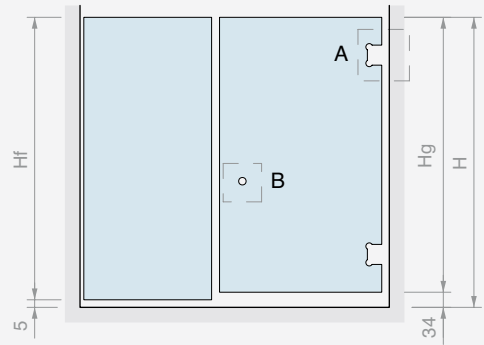
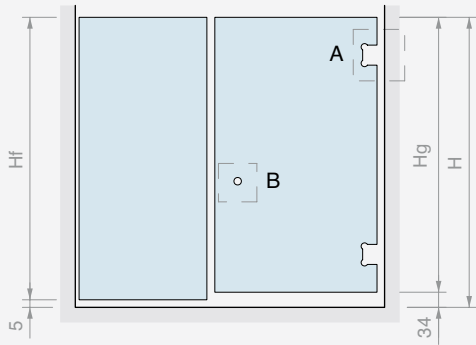

$H_f = H - 5$   
 $H_g = H - 34$   
 $L_g \text{ MAX } 900$   
 $L_f \text{ (MAX } 600) = 5 + L_f + 17 + L_g + 8$   
 $LV = L_g - 30$

$H_f = H - 5$   
 $H_g = H - 34$   
 $L_g \text{ MAX } 900$   
 $L_f \text{ (MAX } 600) = 5 + L_f + 23 + L_g + 11$   
 $LV = L_g - 39$

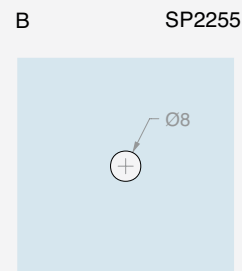
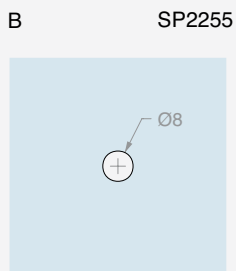
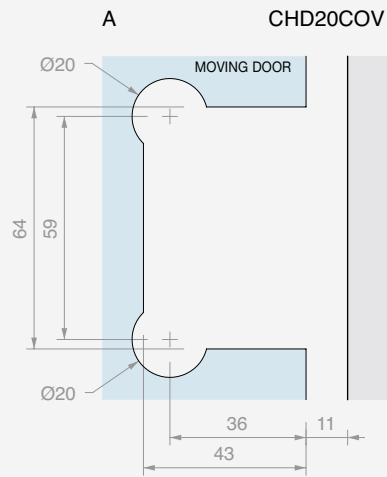
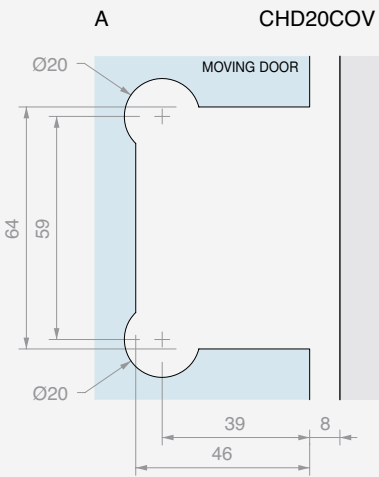

GM1520SX  
GM1520DX

GM0210

GM0622

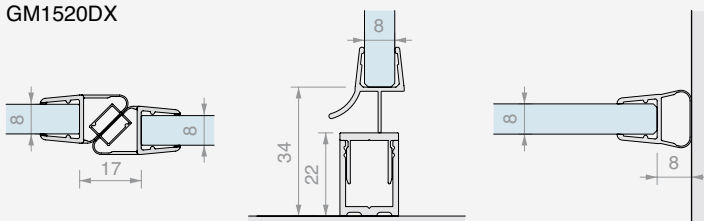

GM1520SX  
GM1520DX

GM0210

GM0622

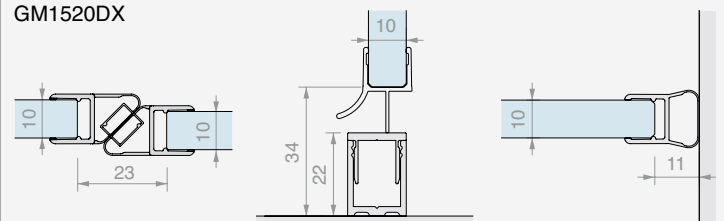





**WALL/GLASS HINGED SHOWER  
KIT WITH FIXED PANE AND CLAMPS**

Finish: /1 /2 /4 /24 /R2

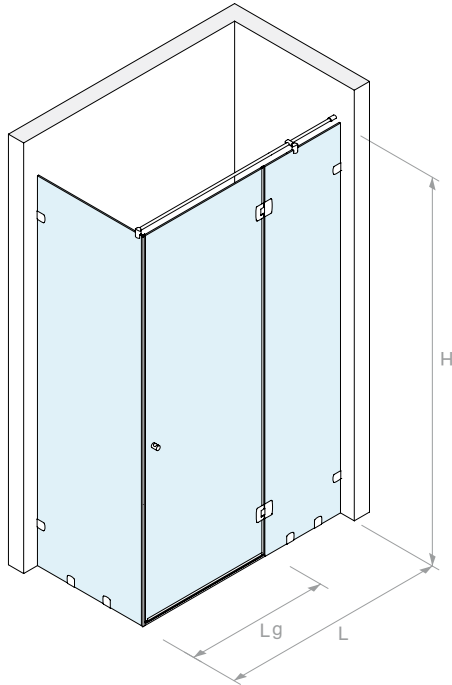



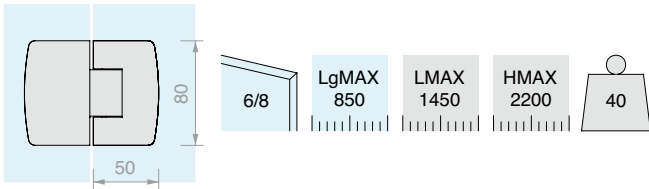



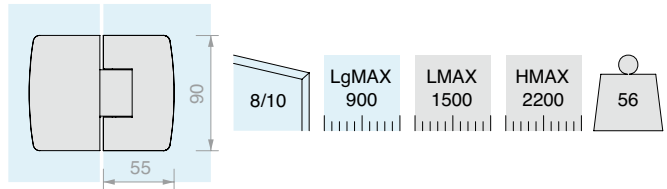

VERSION WITH HINGE **CHD180** 50 mm x 80 mm









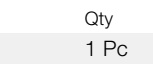

VERSION WITH HINGE **CHD280** 55 mm x 90 mm

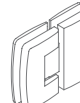
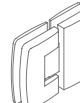

Kit comprising:

Art.	Description	Qty.	
<b>CHD180</b>	In-line adjustable hinge	2 Pcs	
<b>PESQ0810B.100</b>	Water barrier profile	1 Pc	
<b>GM6010</b>	Gasket with drip flap	1 Pc	
<b>GM58</b>	90° strike jamb gasket	1 Pc	
<b>GM62</b>	Balloon gasket	1 Pc	
<b>SP2255</b>	Pair of knobs	1 Pc	
<b>CHDT1500</b>	Fixed stabilizer bar	1 Pc	
<b>CHDA90</b>	Distanced glass fixing	1 Pc	
<b>CHDM41</b>	Clamp flush to the wall	8 Pcs	

Kit comprising:

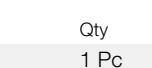
Art.	Description	Qty.	
<b>CHD280</b>	In-line adjustable hinge	2 Pcs	
<b>PESQ0810B.100</b>	Water barrier profile	1 Pc	
<b>GM0210</b>	Gasket with drip flap	1 Pc	
<b>GM5422</b>	90° strike jamb gasket	1 Pc	
<b>GM0422</b>	Gasket with lip	1 Pc	
<b>SP2255</b>	Pair of knobs	1 Pc	
<b>CHDT1500G</b>	Fixed stabilizer bar	1 Pc	
<b>CHDA901</b>	Distanced glass fixing	1 Pc	
<b>CHDM41</b>	Clamp flush to the wall	8 Pcs	

Art. **BDCHD6807** Qty 1 Pc

Art. **BDCHD81007** Qty 1 Pc

GLASS PANE DIMENSIONS

BDCHD6807

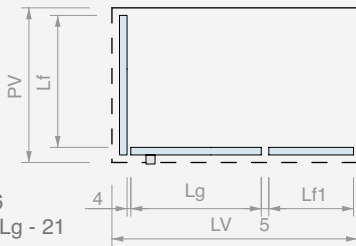
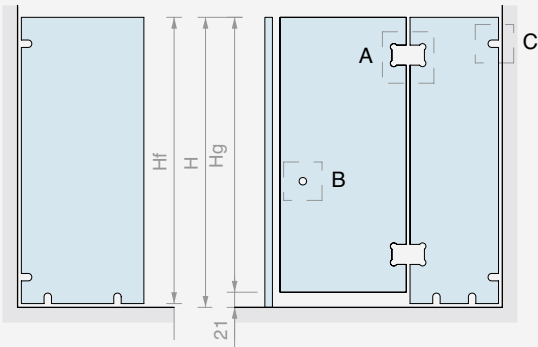

Hf = H - 1  
 Hg = H - 21  
 Lg MAX 850  
 Lf (MAX 800) = PV - 6  
 Lf1 (MAX 600) = LV - Lg - 21

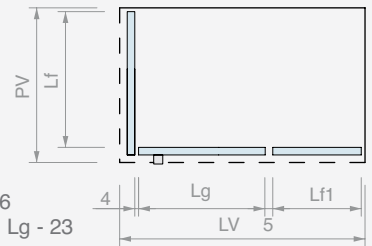
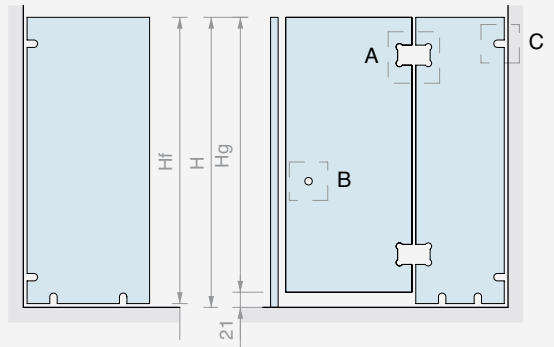

Hf = H - 1  
 Hg = H - 21  
 Lg MAX 850  
 Lf (MAX 800) = PV - 6  
 Lf1 (MAX 600) = LV - Lg - 23

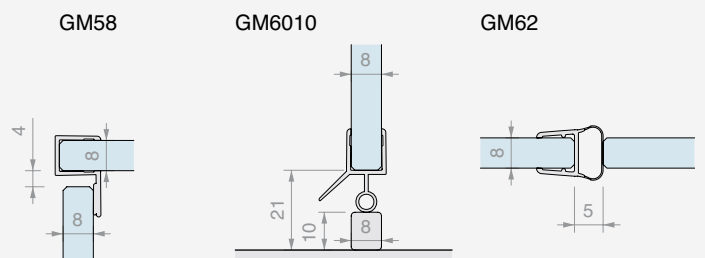
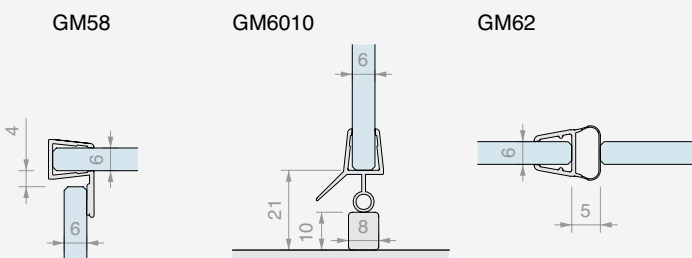
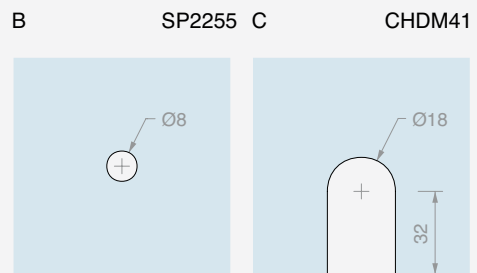
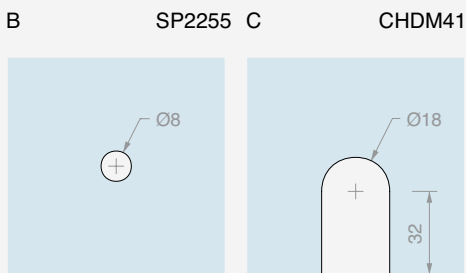
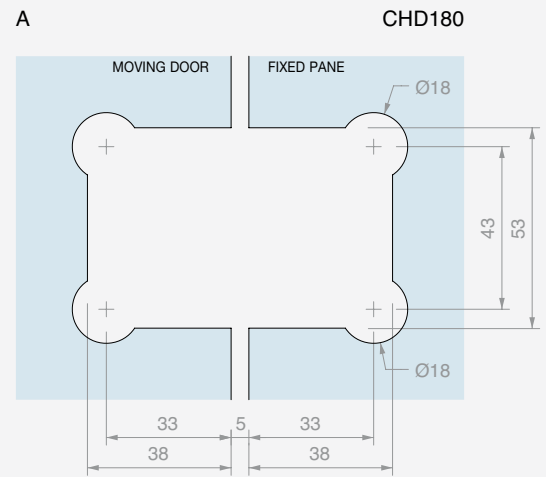
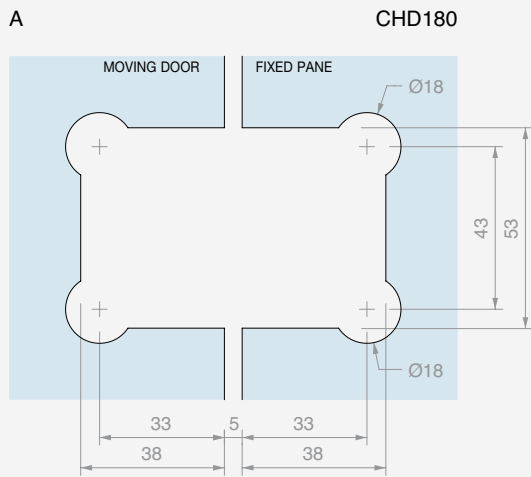

GLASS PANE DIMENSIONS

BDCHD81007

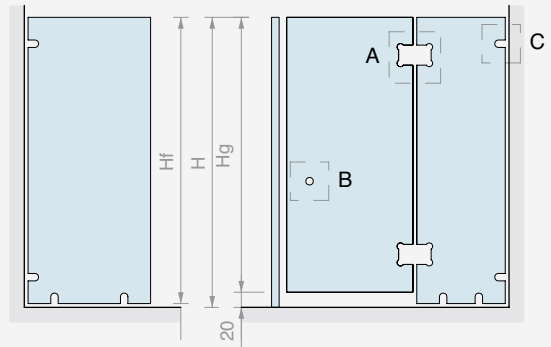
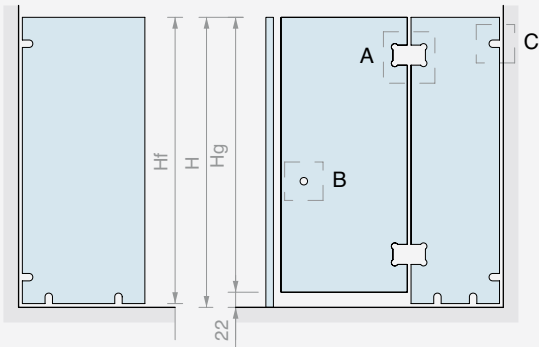

Hf = H - 1  
 Hg = H - 22  
 Lg MAX 900  
 Lf (MAX 800) = PV - 6  
 Lf1 (MAX 600) = LV - Lg - 23

Hf = H - 1  
 Hg = H - 20  
 Lg MAX 900  
 Lf (MAX 800) = PV - 6  
 Lf1 (MAX 600) = LV - Lg - 25

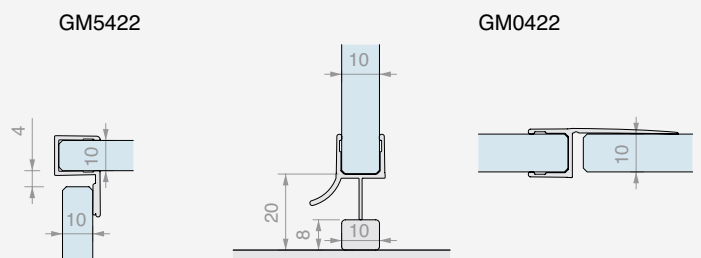
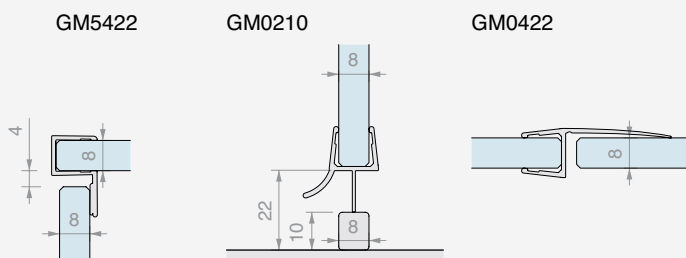
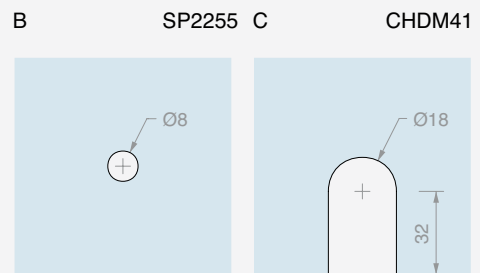
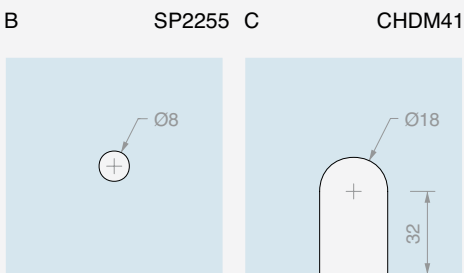
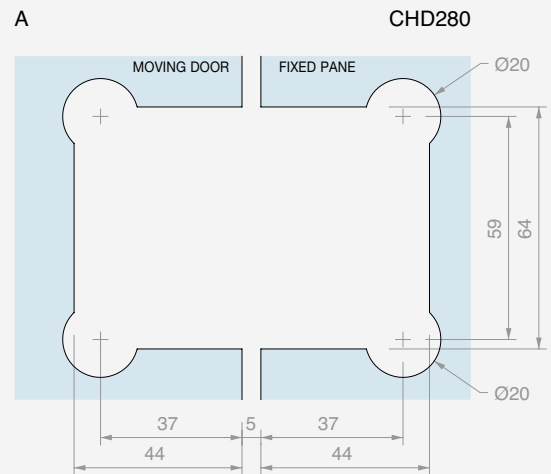
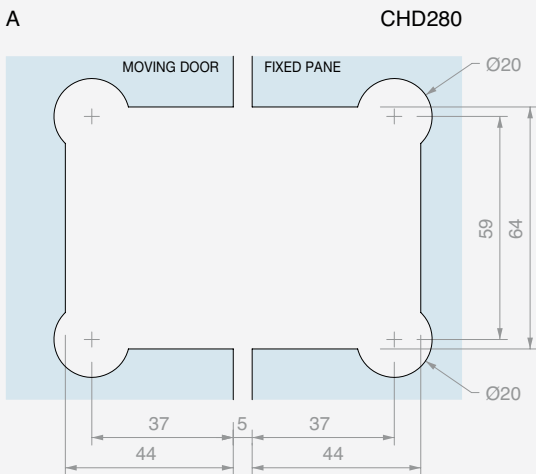



**WALL/WALL CORNER HINGED  
SHOWER KIT WITH FIXED PANE AND CLAMPS**

Finish:     

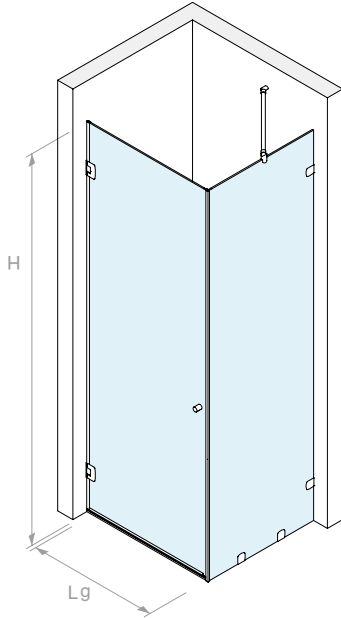

VERSION WITH HINGE **CHD10COV** 50 mm x 80 mm

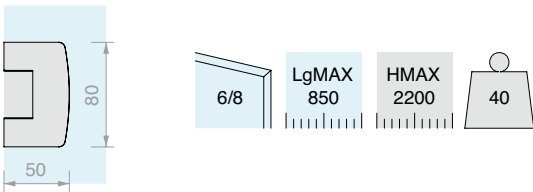

Kit comprising:

Art.	Description	Qty.
<b>CHD10COV</b>	Adjustable side hinge	2 Pcs
<b>PESQ0810B.100</b>	Water barrier profile	1 Pc
<b>GM6010</b>	Gasket with drip flap	1 Pc
<b>GM58</b>	90° strike jamb gasket	1 Pc
<b>GM62</b>	Balloon gasket	1 Pc
<b>SP2255</b>	Pair of knobs	1 Pc
<b>CHDA55</b>	Jointed stabilizer bar	1 Pc
<b>CHDM41</b>	Clamp flush to the wall	4 Pcs

VERSION WITH HINGE **CHD20COV** 55 mm x 90 mm

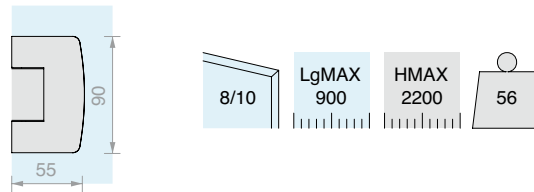

Kit comprising:

Art.	Description	Qty.
<b>CHD20COV</b>	Adjustable side hinge	2 Pcs
<b>PESQ0810B.100</b>	Water barrier profile	1 Pc
<b>GM0210</b>	Gasket with drip flap	1 Pc
<b>GM5422</b>	90° strike jamb gasket	1 Pc
<b>GM0622</b>	Balloon gasket	1 Pc
<b>SP2255</b>	Pair of knobs	1 Pc
<b>CHDA55G</b>	Jointed stabilizer bar	1 Pc
<b>CHDM41</b>	Clamp flush to the wall	4 Pcs

Art.	Qty.
<b>BDCHD6813</b>	1 Pc

Art.	Qty.
<b>BDCHD81013</b>	1 Pc

GLASS PANE DIMENSIONS

BDCHD6813

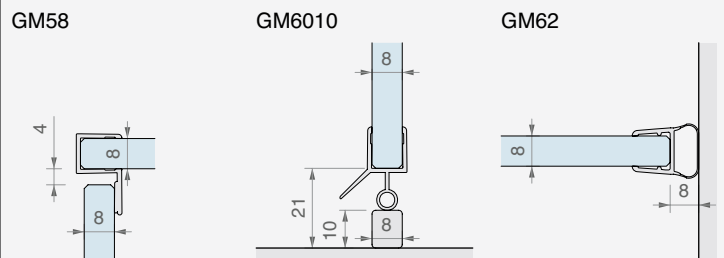
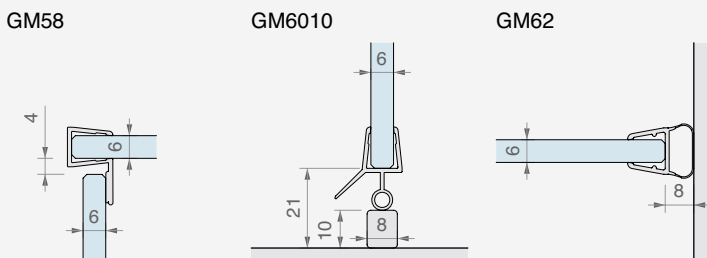
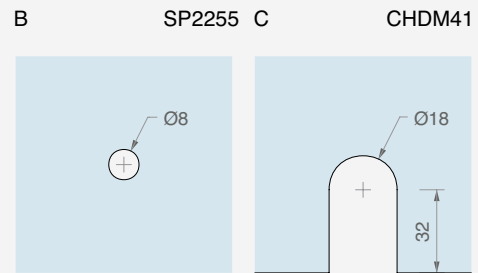
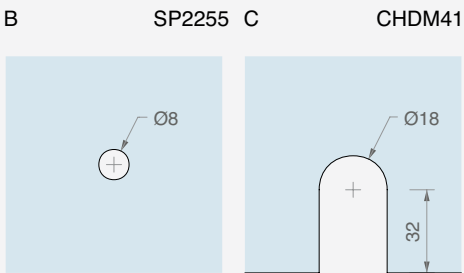
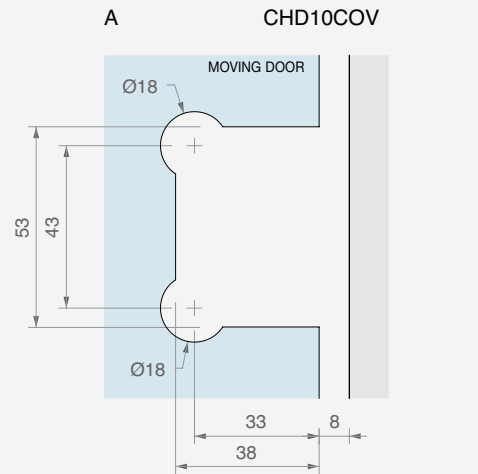
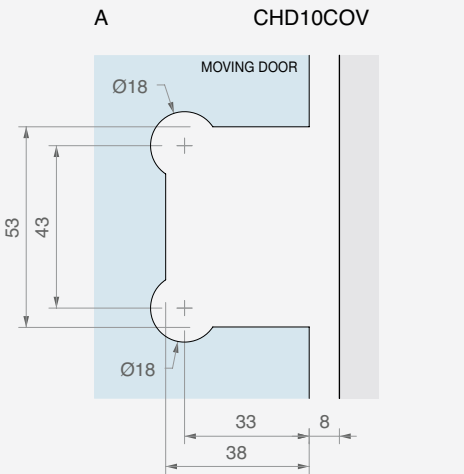
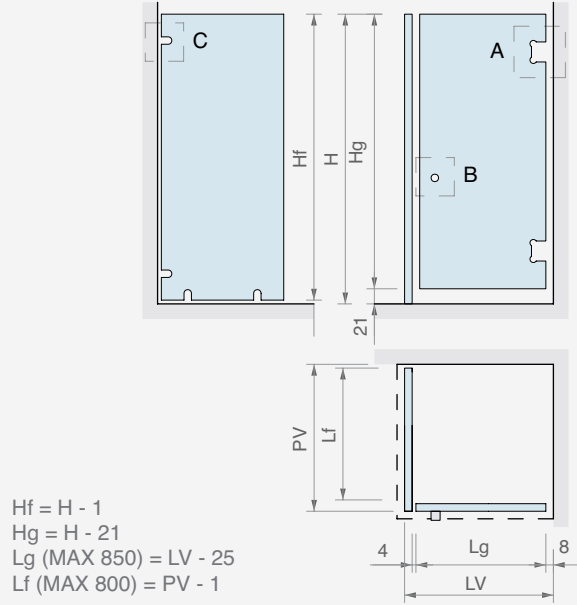
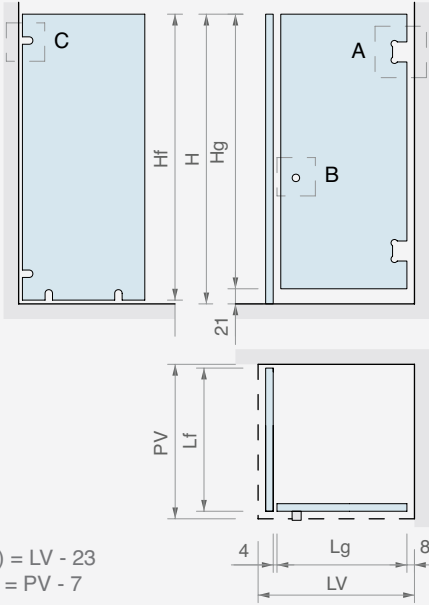

GLASS PANE DIMENSIONS

BDCHD81013

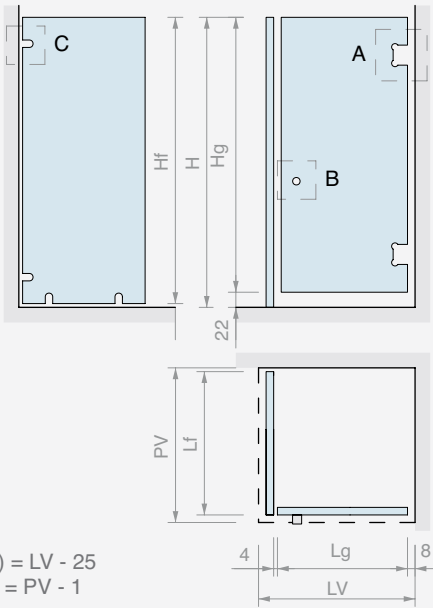

Hf = H - 1  
 Hg = H - 22  
 Lg (MAX 900) = LV - 25  
 Lf (MAX 800) = PV - 1

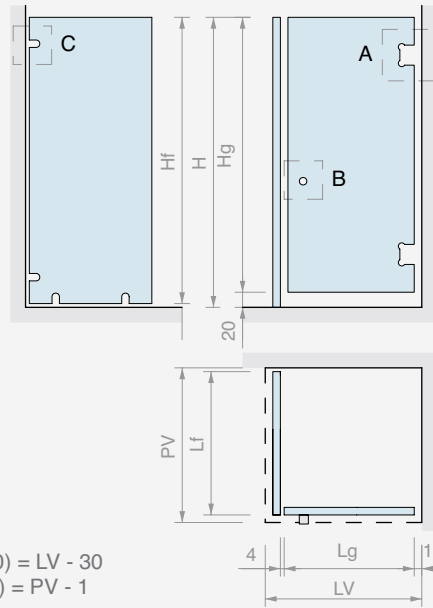

Hf = H - 1  
 Hg = H - 20  
 Lg (MAX 900) = LV - 30  
 Lf (MAX 800) = PV - 1

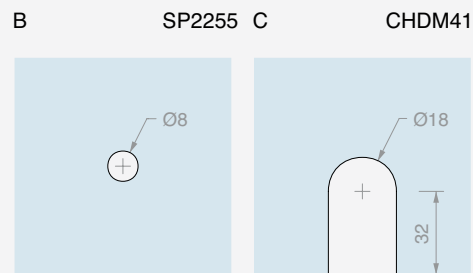
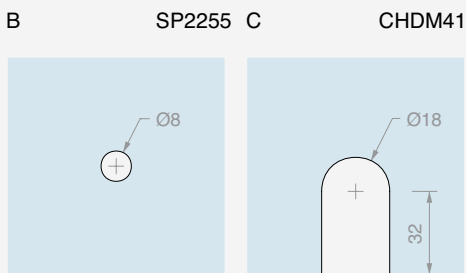
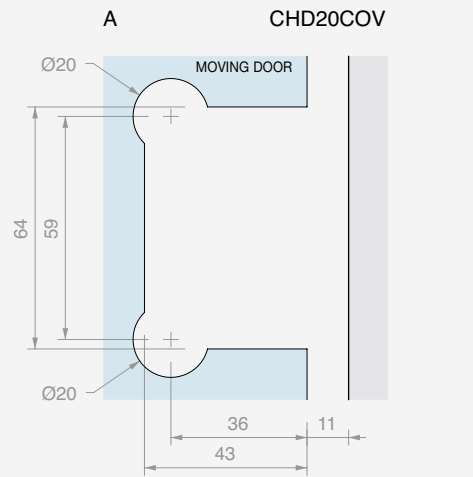
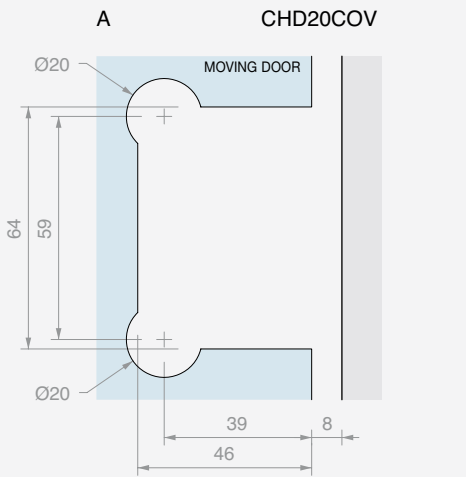

GM5422

GM0210

GM0622

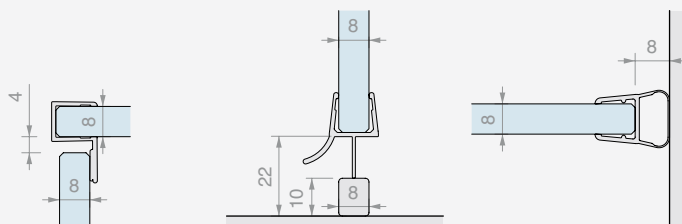

GM5422

GM0210

GM0622

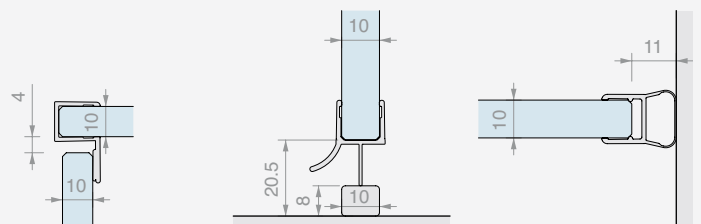





**WALL/WALL CORNER HINGED SHOWER KIT WITH FIXED PANE AND PROFILES**



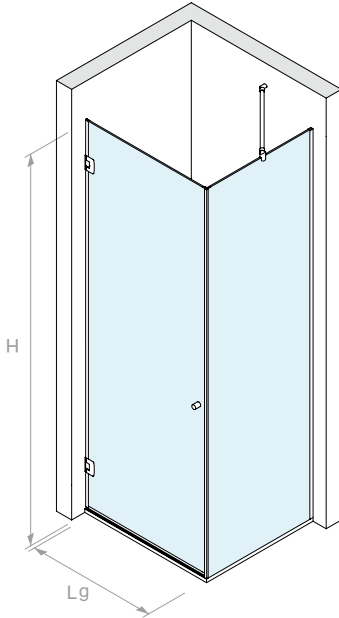



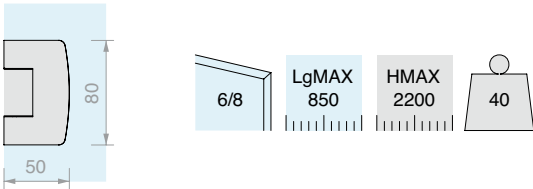



Finish:     



VERSION WITH HINGE **CHD10COV** 50 mm x 80 mm





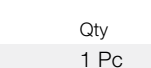



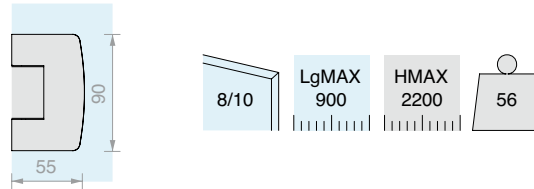



Kit comprising:

Art.	Description	Qty.	
<b>CHD10COV</b>	Adjustable side hinge	2 Pcs	
<b>LMU20B.220</b>	U-shaped profile	2 Pcs	
<b>LMU86B.100</b>	Flat upper profile	1 Pc	
<b>GTUP4</b>	Glass holder gasket	4 m	
<b>GTUP6</b>	Glass holder gasket	4 m	
<b>GM58</b>	90° strike jamb gasket	1 Pc	
<b>GM6010</b>	Gasket with drip flap	1 Pc	
<b>GM62</b>	Balloon gasket	1 Pc	
<b>SP2255</b>	Pair of knobs	1 Pc	
<b>CHDA55</b>	Jointed stabilizer bar	1 Pc	

VERSION WITH HINGE **CHD20COV** 55 mm x 90 mm



Kit comprising:

Art.	Description	Qty.	
<b>CHD20COV</b>	Adjustable side hinge	2 Pcs	
<b>LMU20B.220</b>	U-shaped profile	2 Pcs	
<b>LMU86B.100</b>	Flat upper profile	1 Pc	
<b>GTUP4</b>	Glass holder gasket	4 m	
<b>GTUP2</b>	Glass holder gasket	4 m	
<b>GM5422</b>	90° strike jamb gasket	1 Pc	
<b>GM0210</b>	Gasket with drip flap	1 Pc	
<b>GM0622</b>	Balloon gasket	1 Pc	
<b>SP2255</b>	Pair of knobs	1 Pc	
<b>CHDA55G</b>	Jointed stabilizer bar	1 Pc	

Art. **BDCHD6815** Qty 1 Pc

Art. **BDCHD81015** Qty 1 Pc

GLASS PANE DIMENSIONS

BDCHD6815

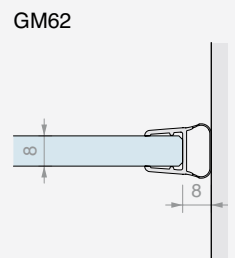
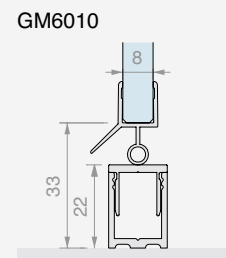
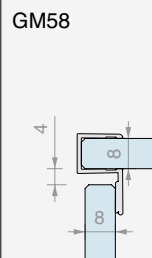
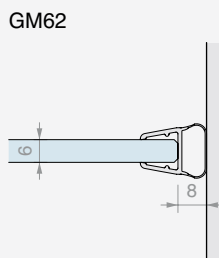
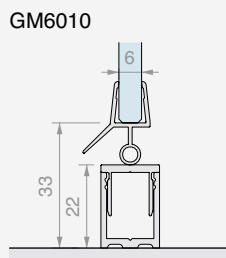
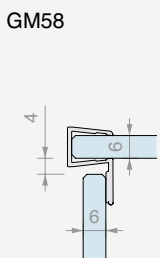
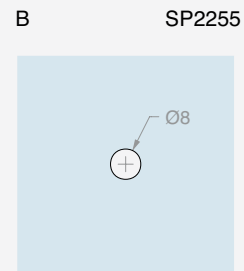
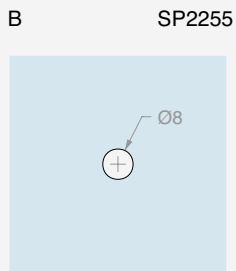
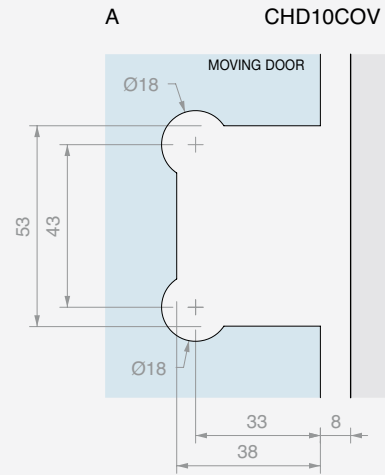
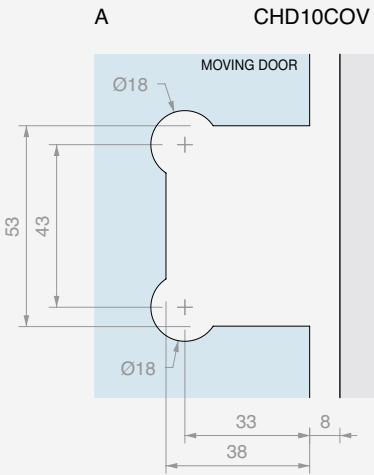
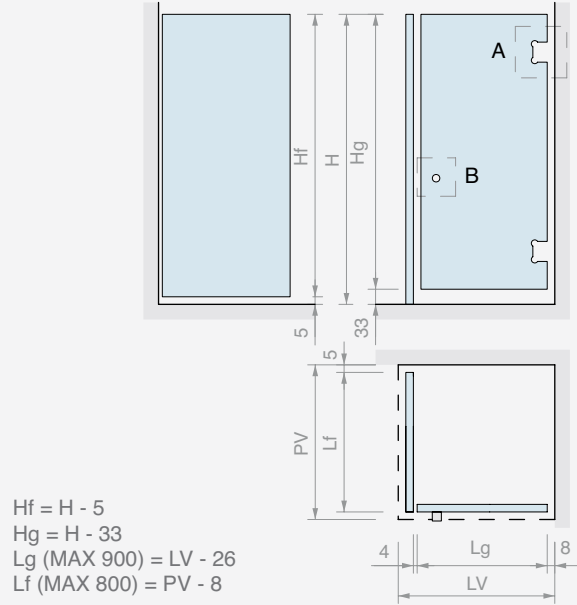
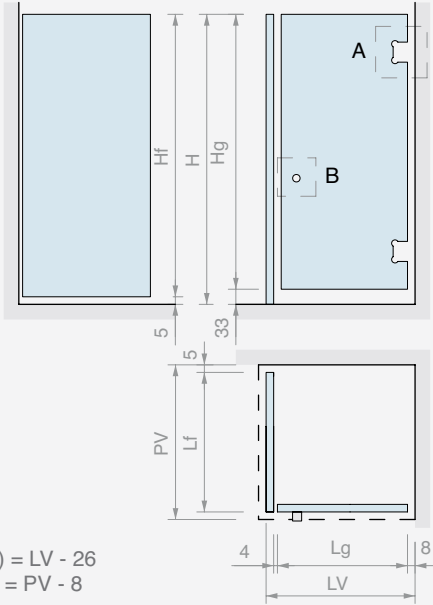

GLASS PANE DIMENSIONS

BDCHD81015

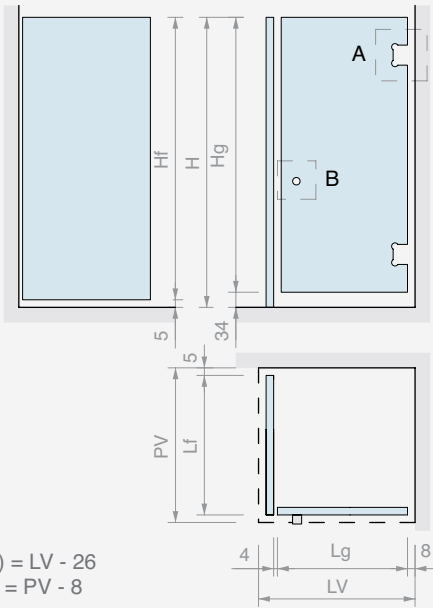

$H_f = H - 5$   
 $H_g = H - 34$   
 $L_g \text{ (MAX 900)} = LV - 26$   
 $L_f \text{ (MAX 800)} = PV - 8$

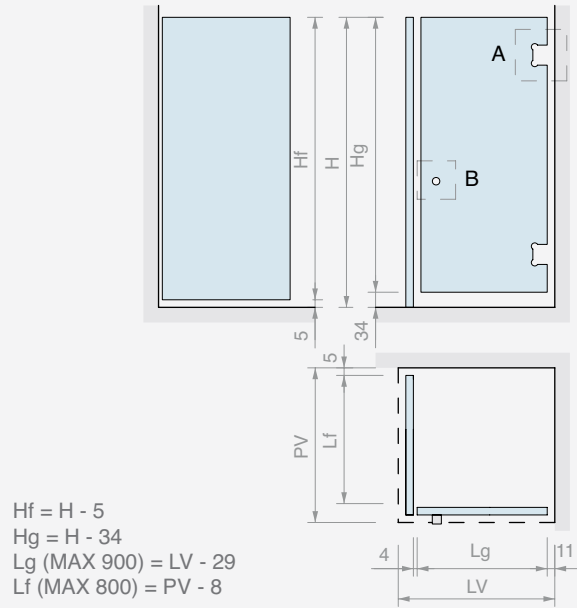

$H_f = H - 5$   
 $H_g = H - 34$   
 $L_g \text{ (MAX 900)} = LV - 29$   
 $L_f \text{ (MAX 800)} = PV - 8$

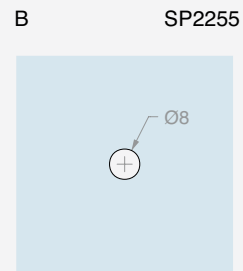
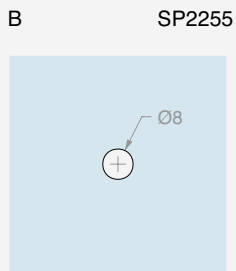
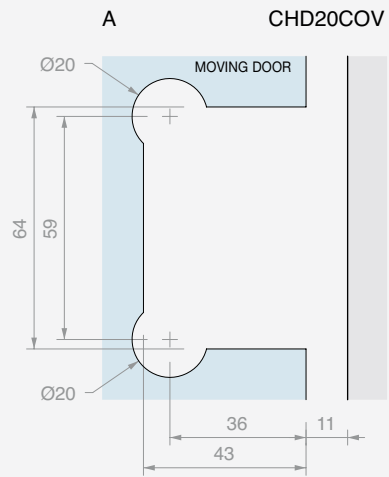
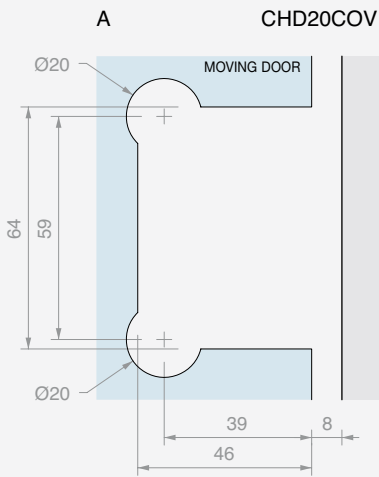

GM5422

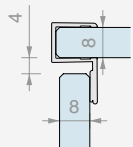

GM0210

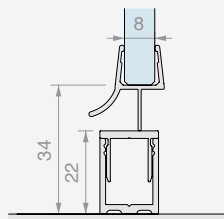

GM0622

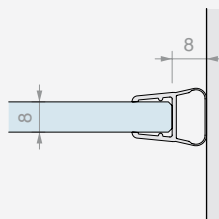

GM5422

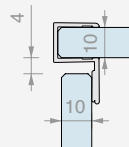

GM0210

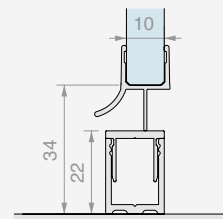

GM0622

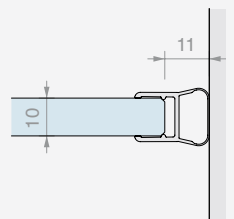



**TWO-SIDE WALK-IN  
SHOWER KIT WITH CLAMPS**

Finish: /1 /2 /4 /24 /R2

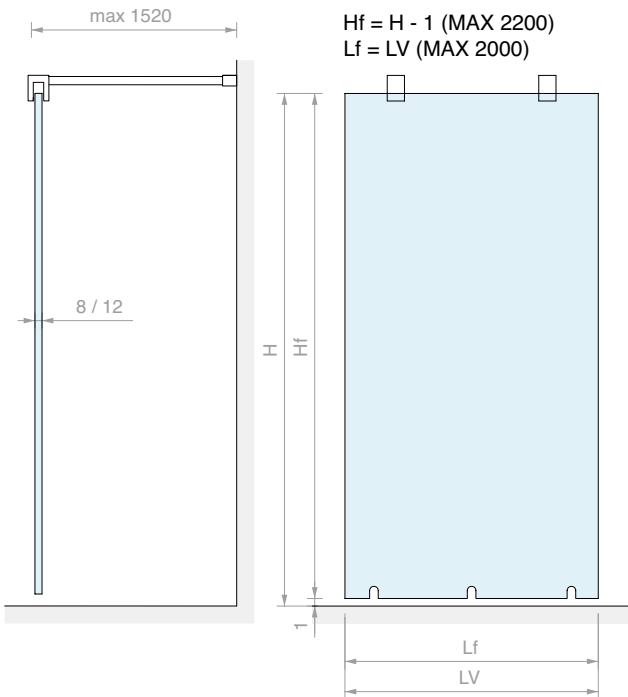
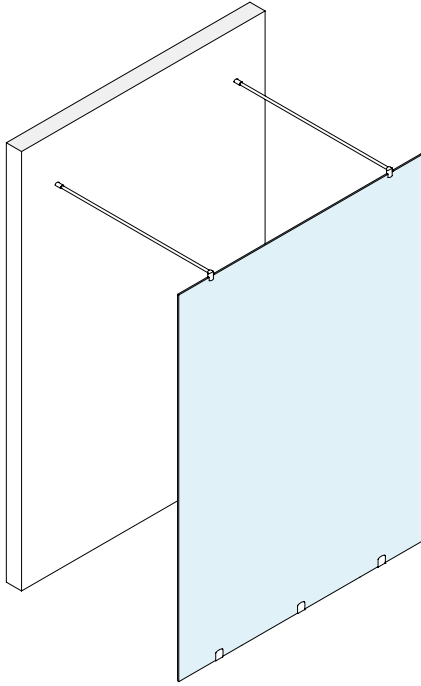

CHDM41

CHDT1500G

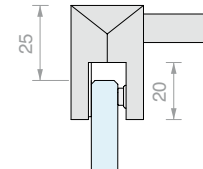
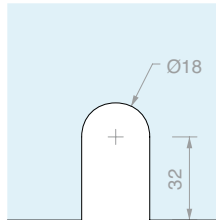

Kit comprising:

Art.	Description	Qty.
<b>CHDM41</b>	Clamp flush to the wall	3 Pcs
<b>CHDT1500G</b>	Fixed stabilizer bar	2 Pcs
Optional		
<b>PESQ0810B.150</b>	Water barrier profile	2 Pcs

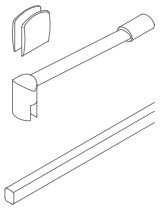

Art.	For glass	Qty
<b>OPEN03CHD</b>	From 8 to 12 mm	1 Pc



**WALK-IN SHOWER KIT WITH CLAMPS**

Finish: /1 /2 /4 /24 /R2

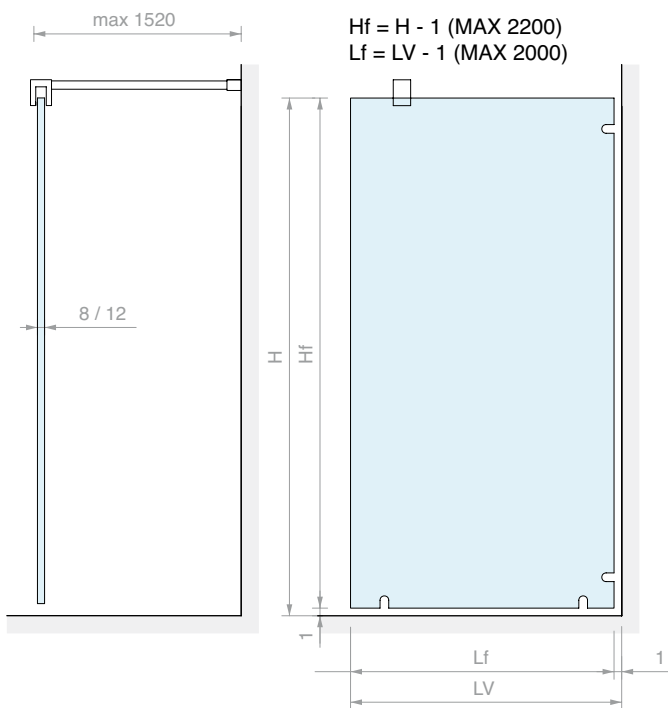
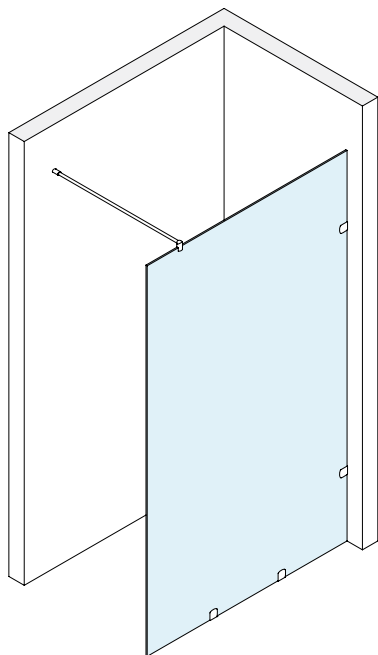

CHDM41

CHDT1500G

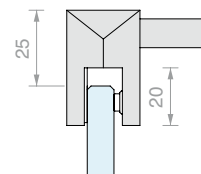
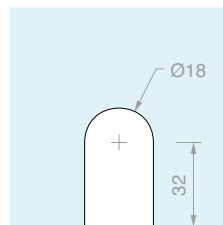

Kit comprising:

Art.	Description	Qty.
<b>CHDM41</b>	Clamp flush to the wall	4 Pcs
<b>CHDT1500G</b>	Fixed stabilizer bar	1 Pc
Optional		
<b>PESQ0810B.150</b>	Water barrier profile	1 Pc

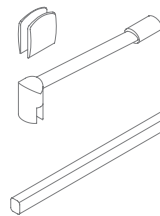

Art.	For glass	Qty
<b>OPEN01CHD</b>	From 8 to 12 mm	1 Pc







# TABLE OF CHD SERIES ACCESSORIES







**Hinges** for glass thickness from 6 to 8 mm

						
CHD10COV	CHD10	CHD12	CHD14	CHD180	CHD190	CHD1135
Page 282	Page 283	Page 284	Page 285	Page 286	Page 287	Page 288







**Hinges** for glass thickness from 8 to 12 mm

								
CHD20COV	CHD20	CHD22	CHD24	CHD24P	CHD280	CHD280P	CHD290	CHD2135
Page 289	Page 290	Page 291	Page 292	Page 293	Page 294	Page 295	Page 296	Page 297











**Locks** for glass thickness from 8 to 10 mm

						
CSP75	CSP85	CLP23	CLPM29	CLS18	CLM19	CL105
Page 298	Page 298	Page 298	Page 298	Page 299	Page 299	Page 299

**Clamps** for glass thickness from 6 to 10 mm

					
CHDM41	CHDM43	CHDM57	CHDM52	CHDM47	CHDM45
Page 300	Page 300	Page 300	Page 301	Page 301	Page 301









**Stabilizer bars**

											
From 6 to 8 mm	CHDT	CHDA500	CHDA55	CHDA05	CHDA83	CHDA85	CHDA86	CHDA90	CHDA93	CHDA88	DQMP
	Page 302	Page 303	Page 303	Page 304	Page 304	Page 304	Page 305	Page 305	Page 305	Page 305	Page 306
From 10 to 12 mm	CHDTG	CHDA55G	CHDA500G		CHDA831	CHDA851	CHDA861	CHDA901			
	Page 302	Page 303	Page 303		Page 304	Page 304	Page 305	Page 305			









**Knobs** for glass thickness from 8 to 12 mm

		
SP2255	SP255	VETCIL35
Page 306-307	Page 307	Page 307

**Profiles for fixed panes and caps**

								
From 6 to 12 mm	LMU20B	LMU86B	LMU20TPB	PESQB	PBD3183	PBD3184	PBD3186	PBDTP
	Page 308	Page 308	Page 308	Page 308	Page 309	Page 309	Page 309	Page 309

**Gaskets**

								
From 6 to 8 mm	GM62	GM12SX	GM12DX	GM58	GM60			GTUP
	Page 310	Page 310	Page 310	Page 310	Page 310			Page 311
From 8 to 10 mm	GM06	GM1520SX	GM1520DX	GM54		GM02	GM0422	
	Page 310	Page 311	Page 311	Page 311		Page 311	Page 311	



**WALL/GLASS ADJUSTABLE  
SIDE HINGE**

Material: Brass

Finish: /1 /2 /4 /24 /R2

Spare plate CHDMP1 on p. 306

6/8

MAX 850

40

CLOSING RETURN: 30°(MAX.)

±10° ADJUSTMENT: 10°(MAX.)

±90° ROTATION: STOP 90°(MAX.)

NO VISIBLE SCREWS

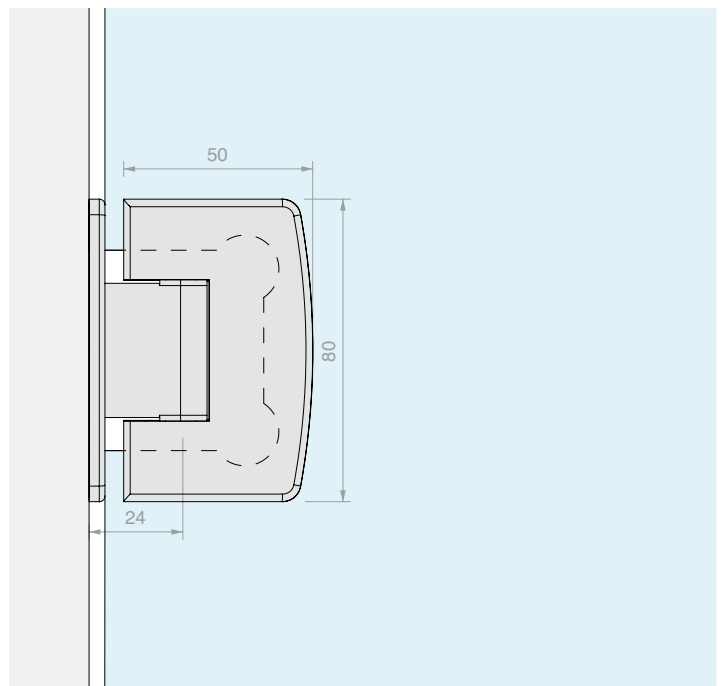
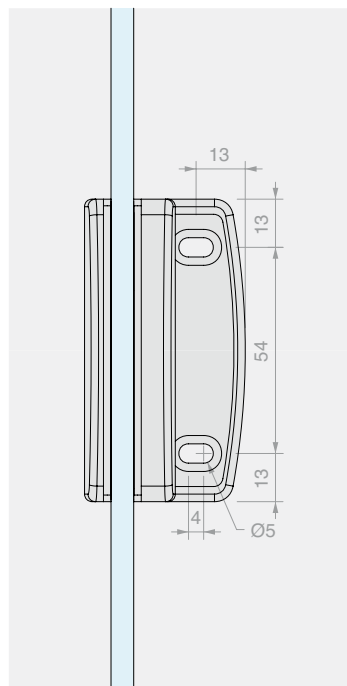
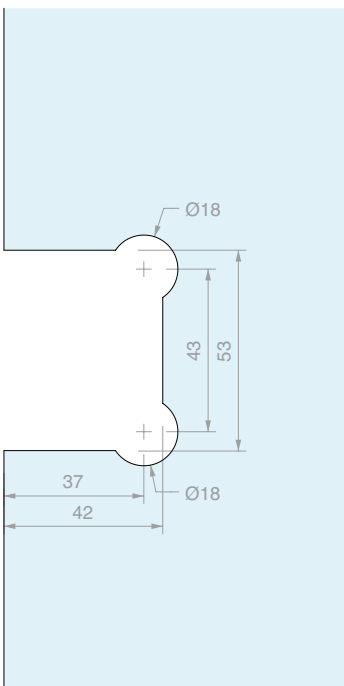
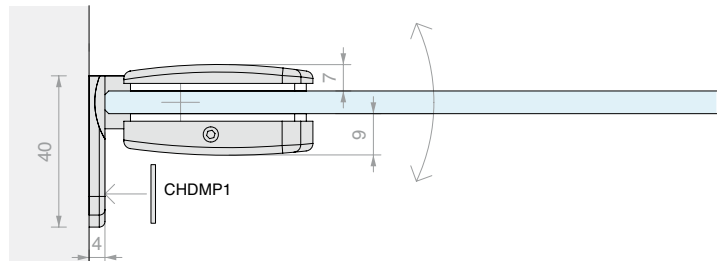

Art.  
**CHD10COV**

For glass  
From 6 to 8 mm

Qty  
1 Pc



**WALL/GLASS ADJUSTABLE  
SIDE HINGE**

Material: Brass

Finish: /1 /24

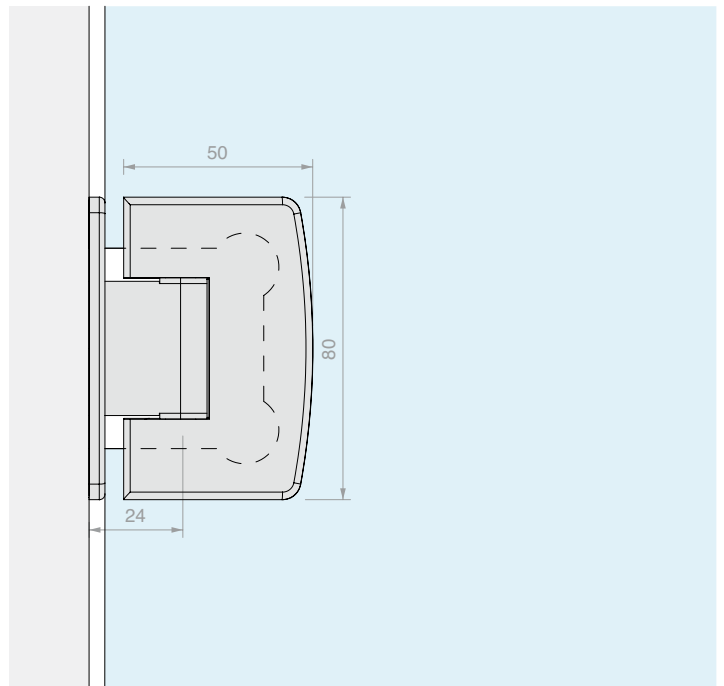
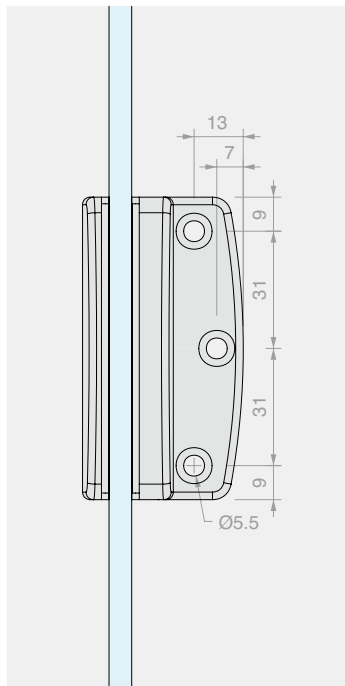
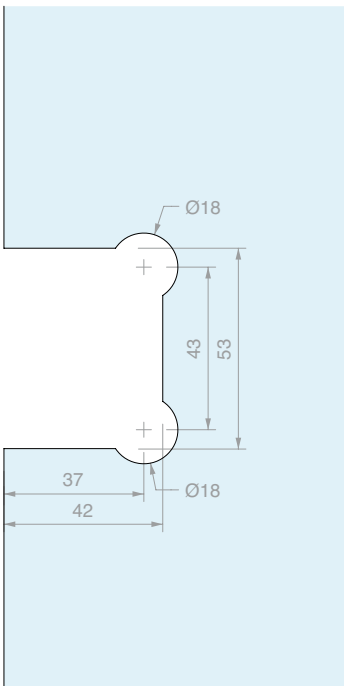
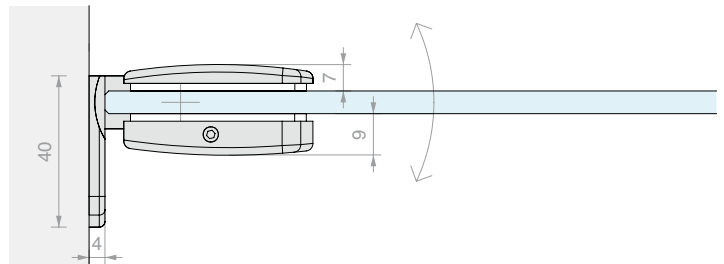
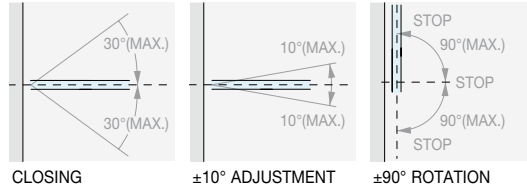

Art.  
**CHD10**

For glass  
From 6 to 8 mm

Qty  
1 Pc



**WALL/GLASS ADJUSTABLE  
CENTRAL HINGE**

Material: Brass

Finish: /1 /24

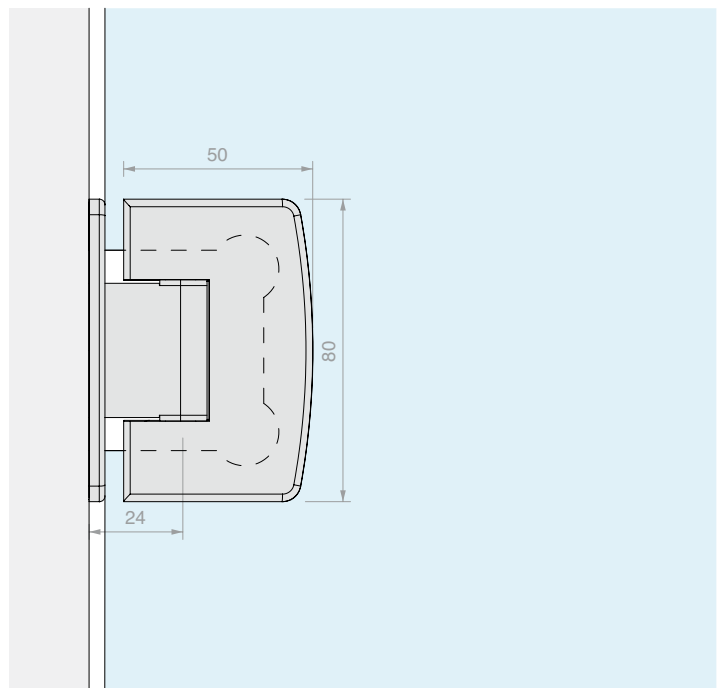
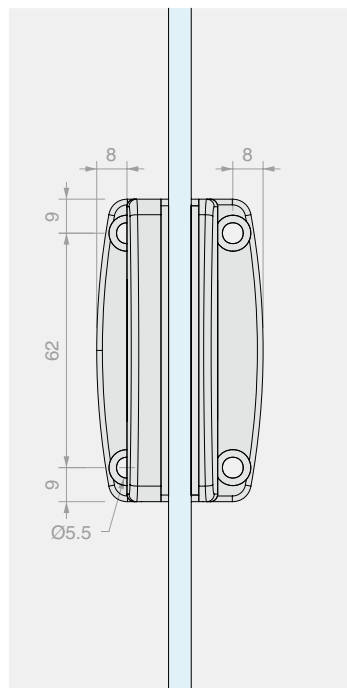
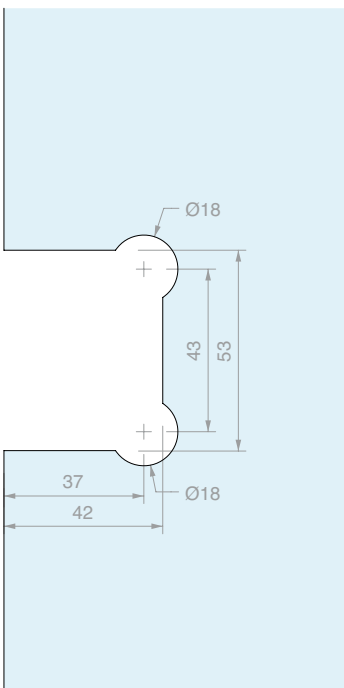
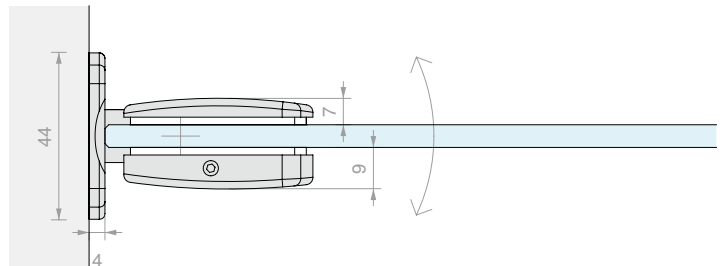
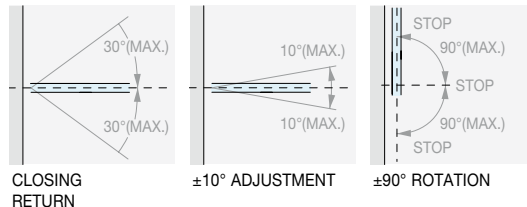

Art.  
**CHD12**

For glass  
From 6 to 8 mm

Qty  
1 Pc



**WALL/GLASS ADJUSTABLE HINGE FOR NARROW JAMBS**

Material: Brass  
 Finish: /1 /24  
 Spare plate DQMP9 on p. 306











CLOSING RETURN



±10° ADJUSTMENT



±90° ROTATION



NO VISIBLE SCREWS

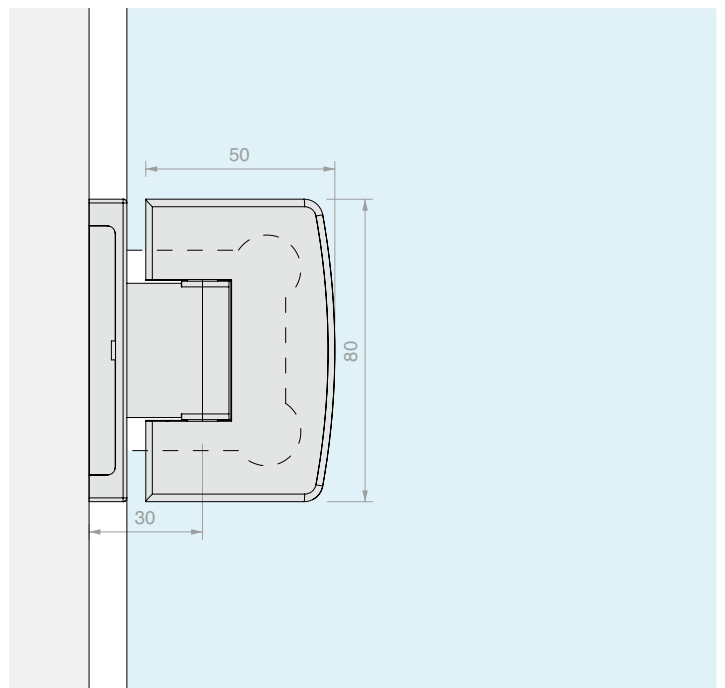
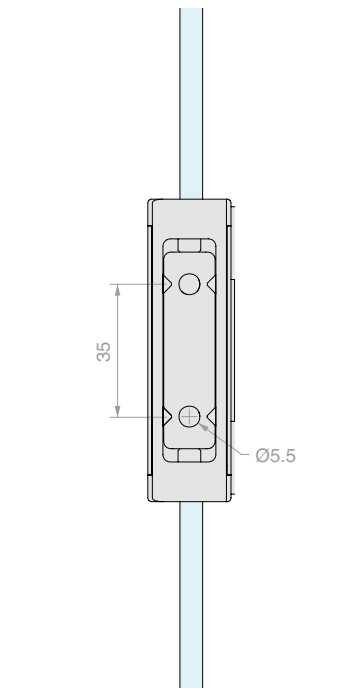
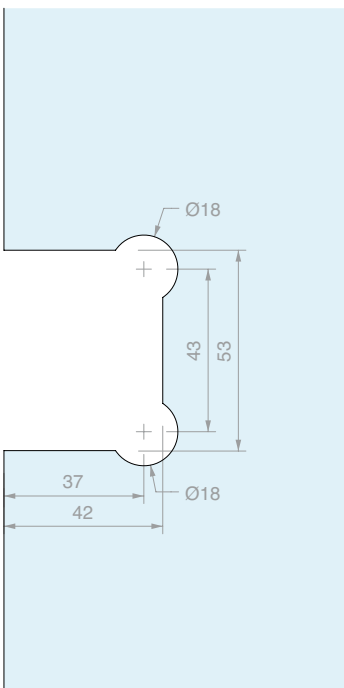
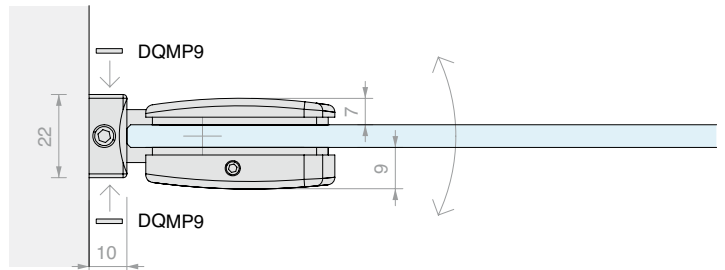

Art.	For glass	Qty
<b>CHD14</b>	From 6 to 8 mm	1 Pc



**GLASS/GLASS ADJUSTABLE  
IN-LINE HINGE**

Material: Brass  
Finish: /1 /2 /4 /24 /R2



6/8

MAX 850

40

CLOSING RETURN

±10° ADJUSTMENT

±90° ROTATION

NO VISIBLE SCREWS

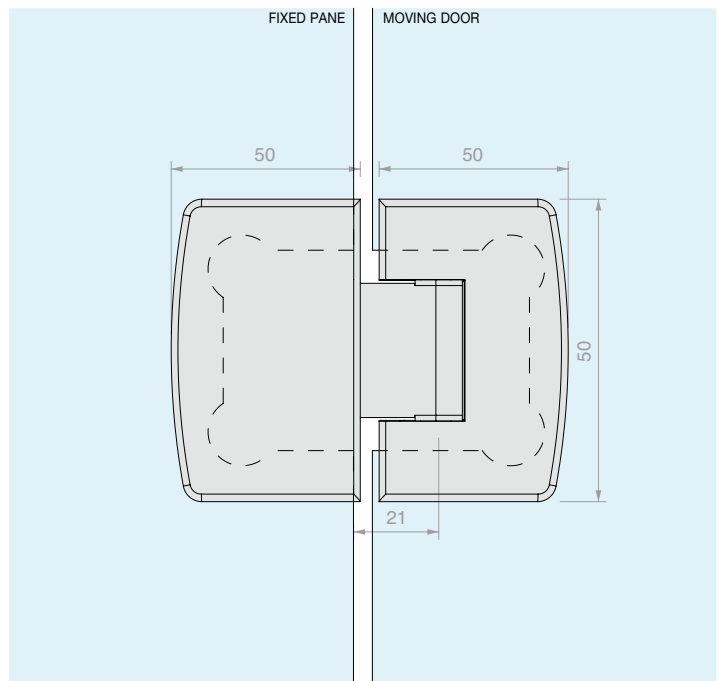
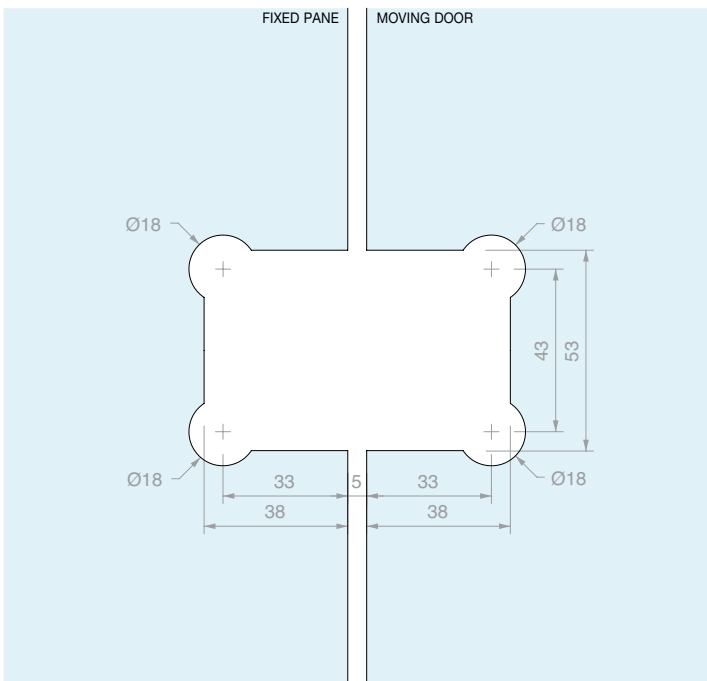
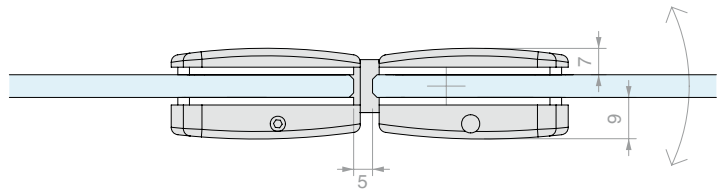

Art.  
**CHD180**

For glass  
From 6 to 8 mm

Qty  
1 Pc



**GLASS/GLASS 90°  
ADJUSTABLE HINGE**

Material: Brass

Finish: /1 /24

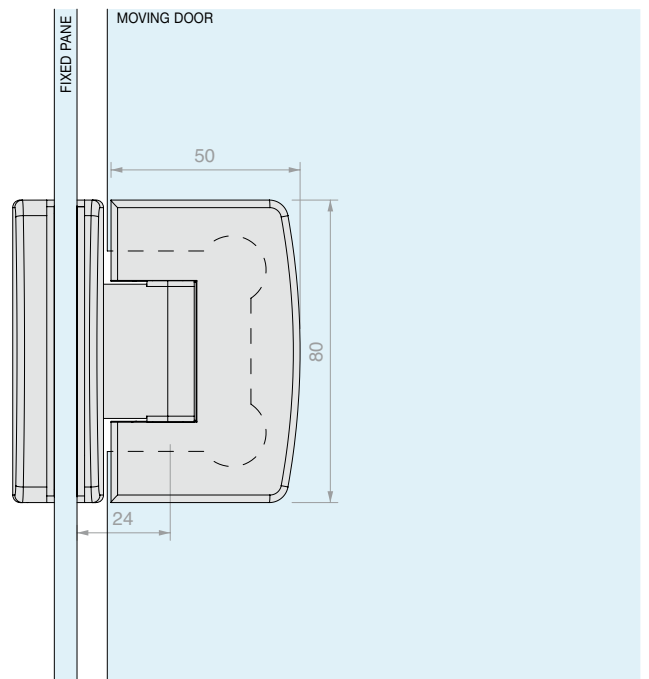
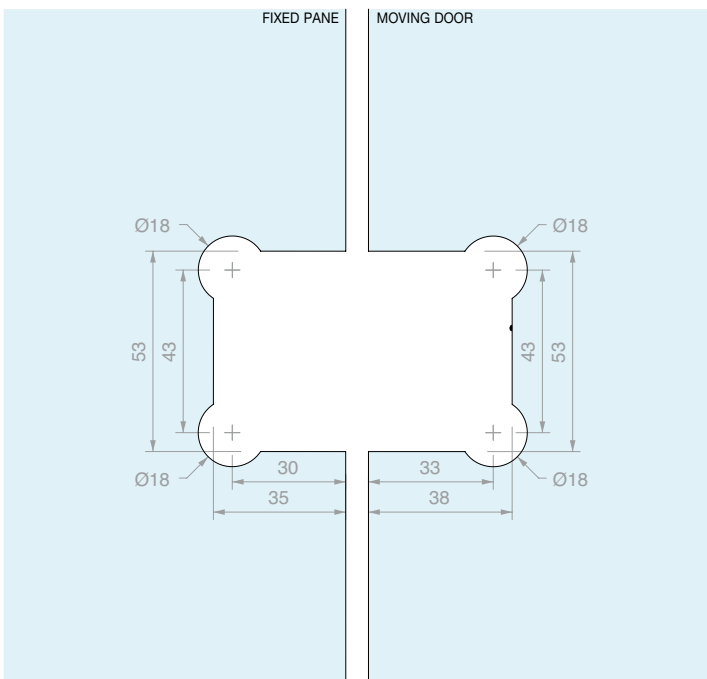
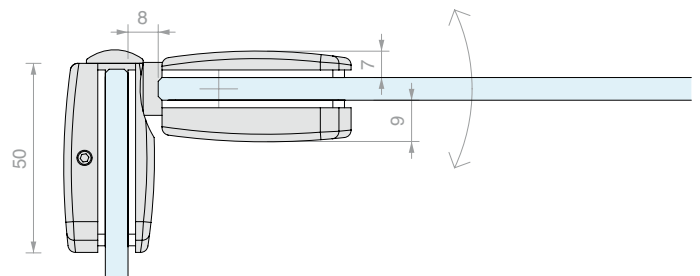
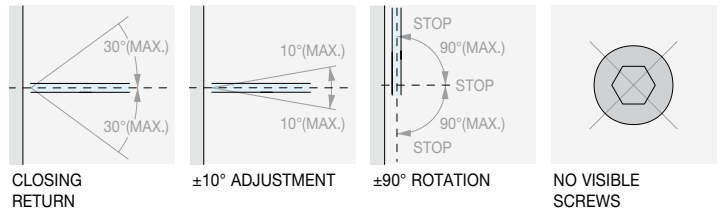

Art.  
**CHD190**

For glass  
From 6 to 8 mm

Qty  
1 Pc



**GLASS/GLASS 135°  
ADJUSTABLE HINGE**

Material: Brass  
Finish: /1 /24

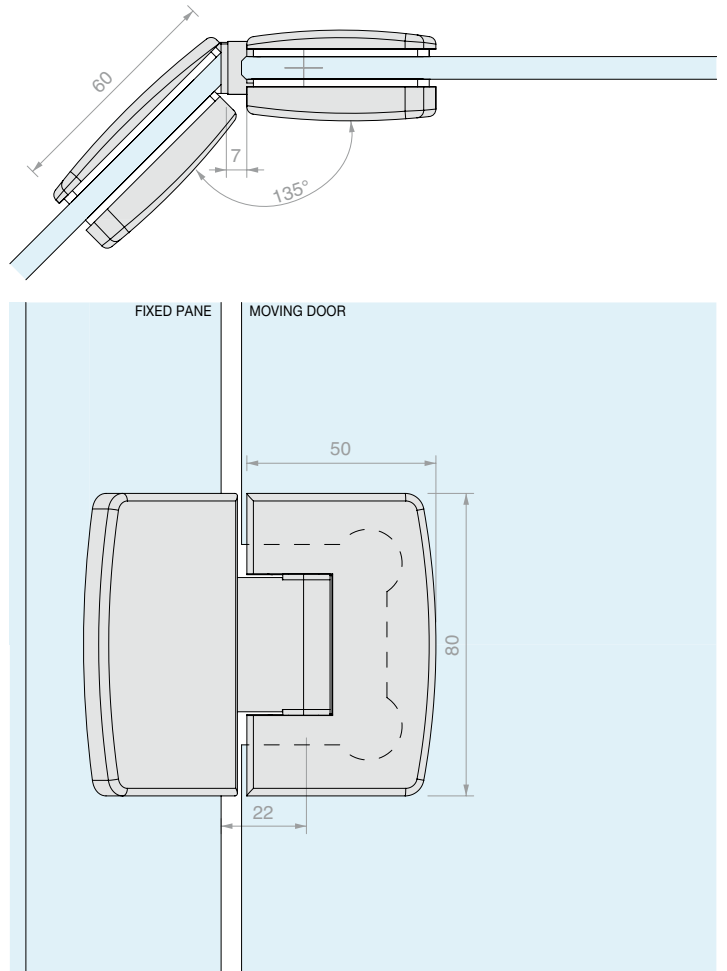
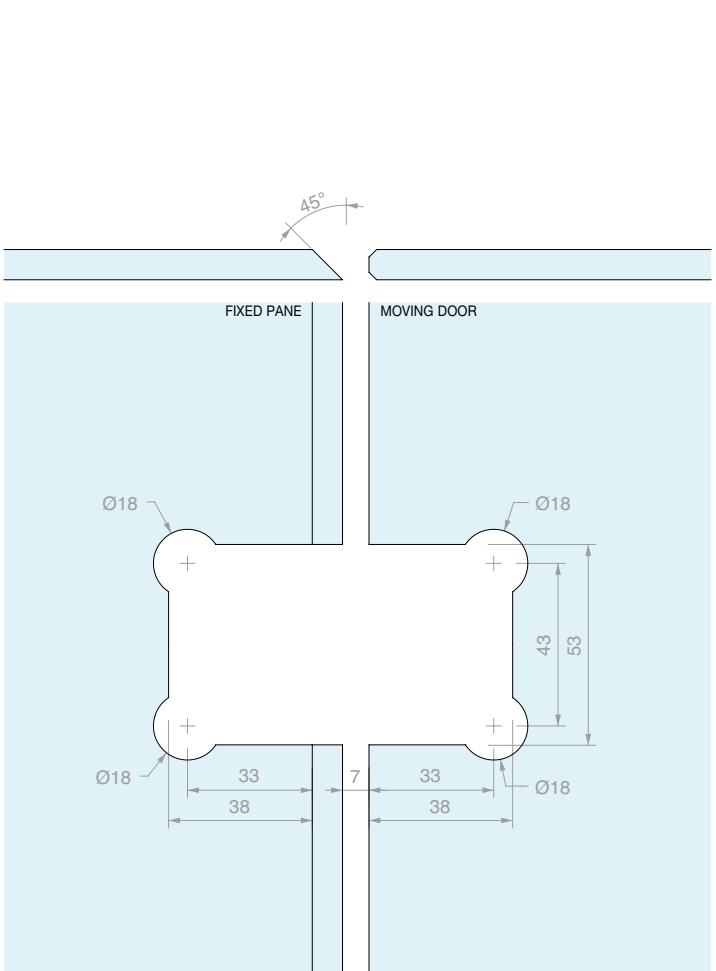
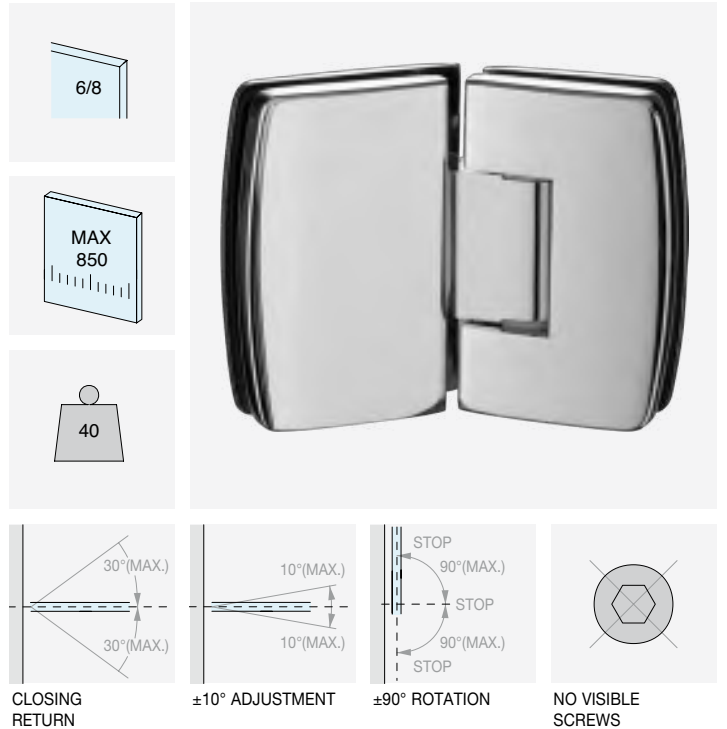

Art. **CHD1135** For glass From 6 to 8 mm

Qty 1 Pc





**WALL/GLASS ADJUSTABLE  
SIDE HINGE**

Material: Brass  
 Finish: /1 /2 /4 /24 /R2  
 Spare plate CHDMP2 on p. 306





8/12



MAX  
900



56





CLOSING RETURN



±10° ADJUSTMENT



±90° ROTATION



NO VISIBLE SCREWS

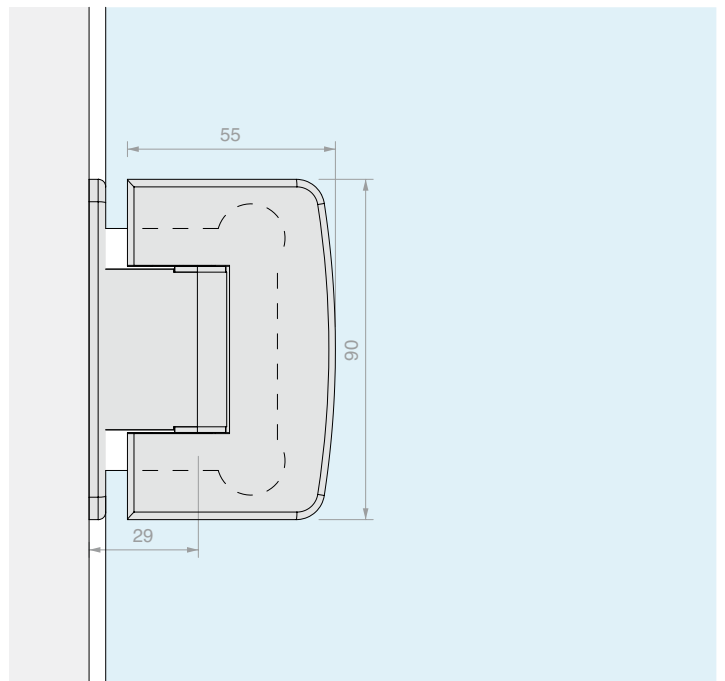
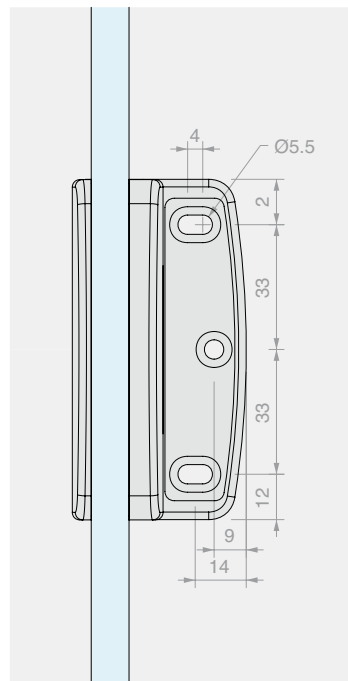
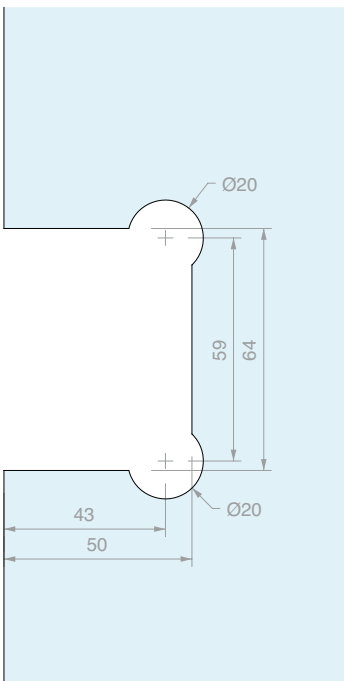
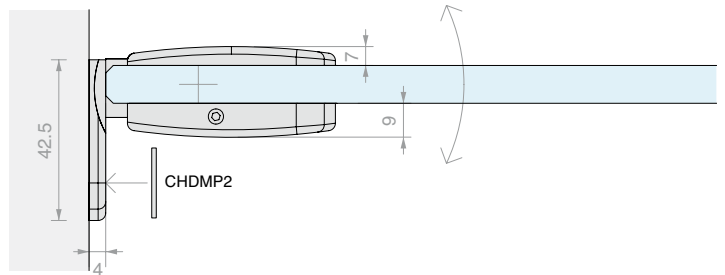

Art.  
**CHD20COV**

For glass  
From 8 to 12 mm

Qty  
1 Pc



**WALL/GLASS ADJUSTABLE  
SIDE HINGE**

Material: Brass

Finish: /1 /24

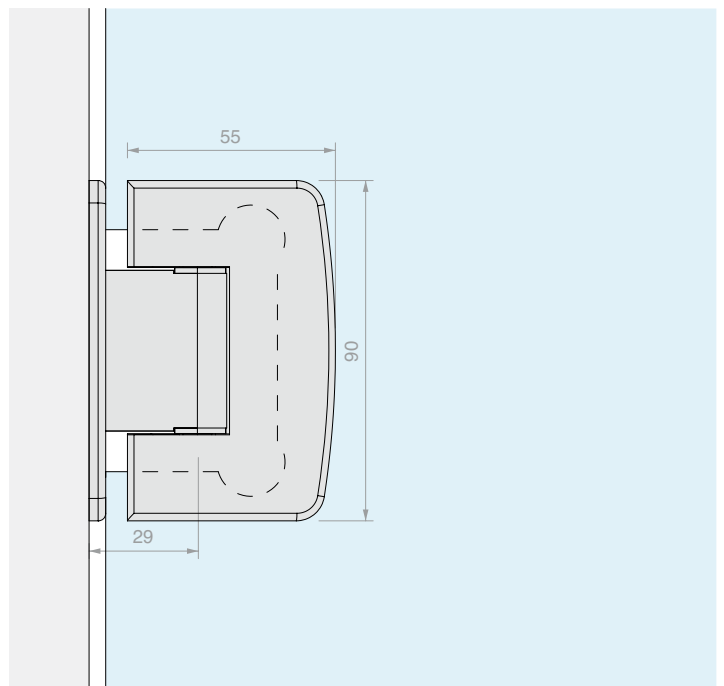
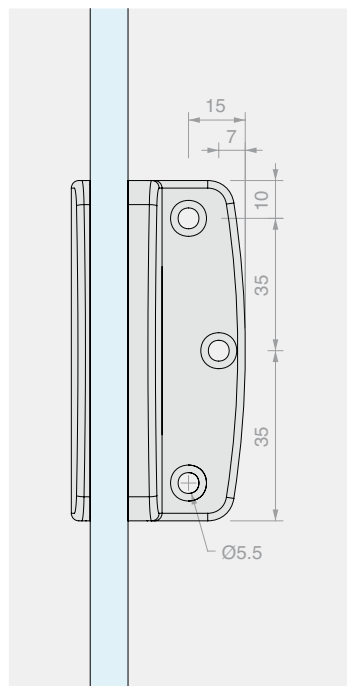
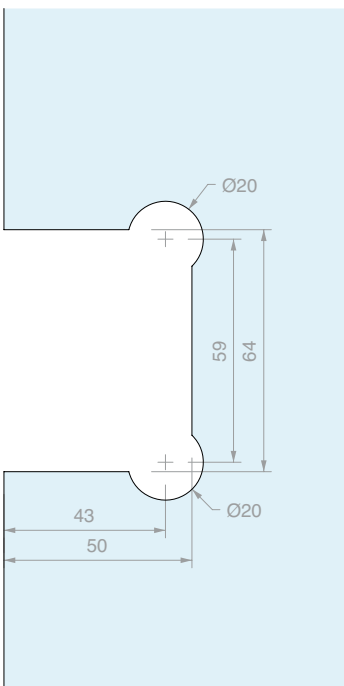
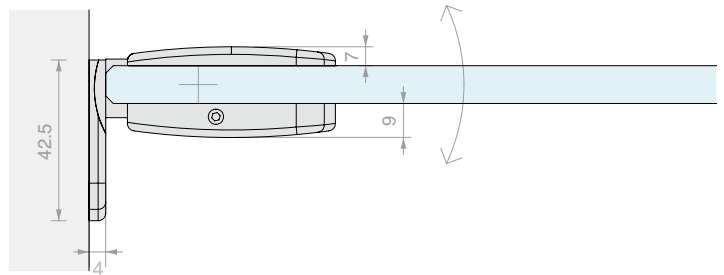
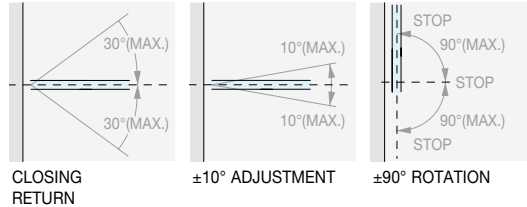

Art.  
**CHD20**

For glass  
From 8 to 12 mm

Qty  
1 Pc



**WALL/GLASS ADJUSTABLE  
CENTRAL HINGE**

Material: Brass

Finish: /1 /24

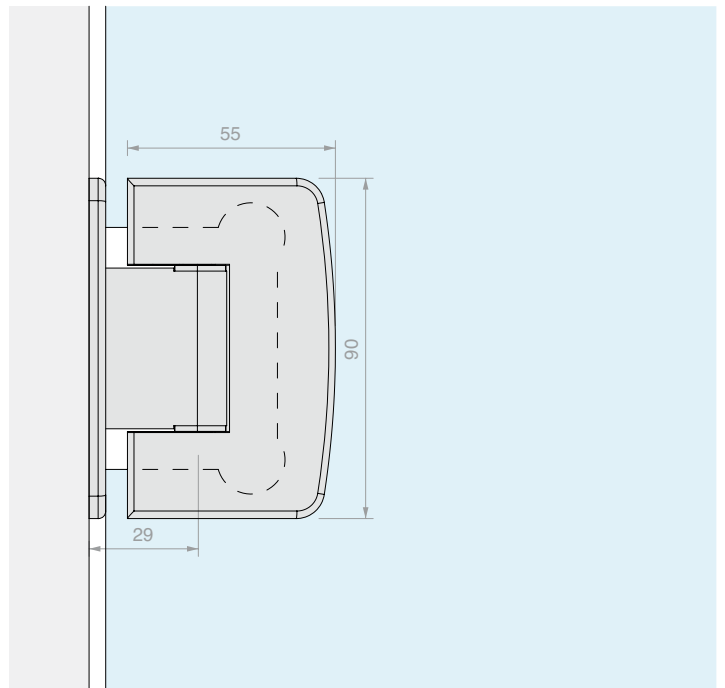
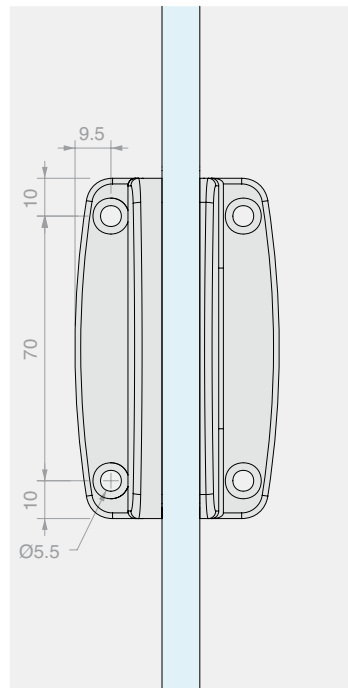
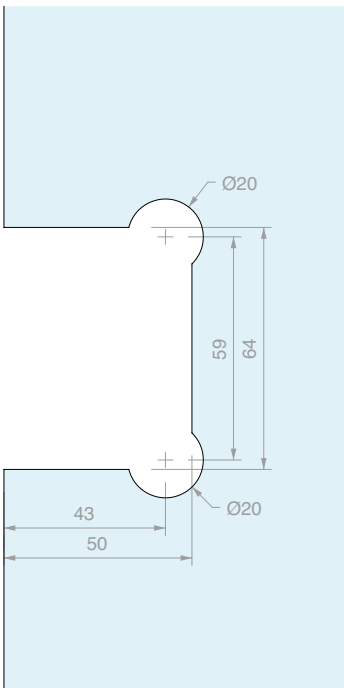
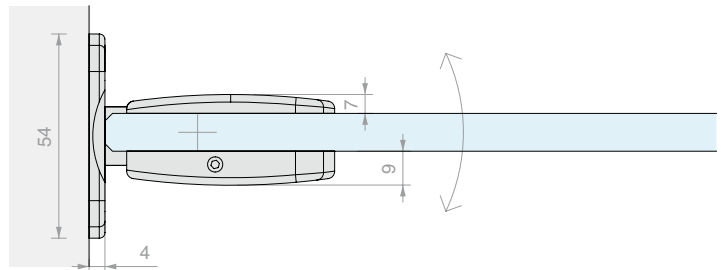
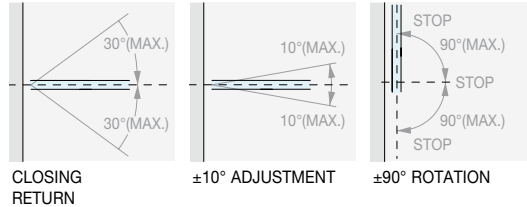

Art.  
**CHD22**

For glass  
From **8** to **12** mm

Qty  
1 Pc



**WALL/GLASS ADJUSTABLE HINGE FOR NARROW JAMBS**

Material: Brass  
 Finish: /1 /24  
 Spare plate DQMP9 on p. 306



8/12

MAX 900

56

CLOSING RETURN

±10° ADJUSTMENT

±90° ROTATION

NO VISIBLE SCREWS

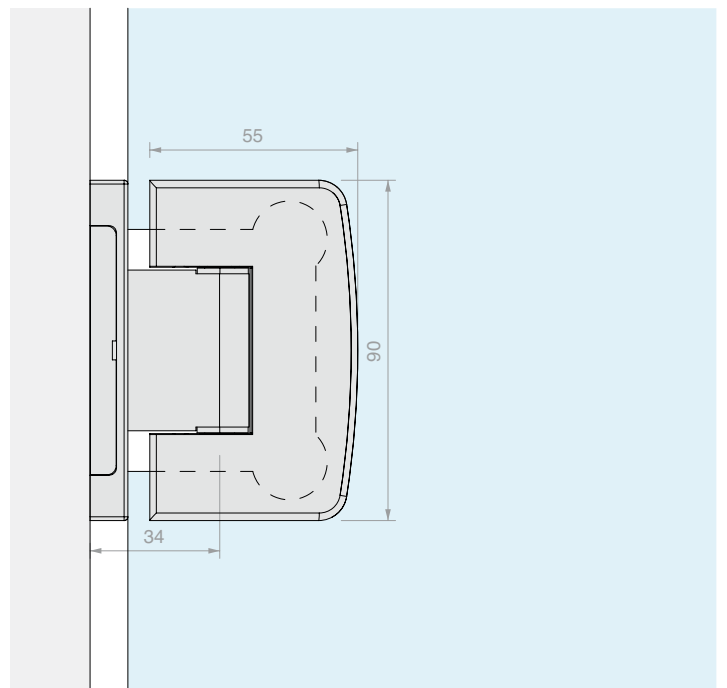
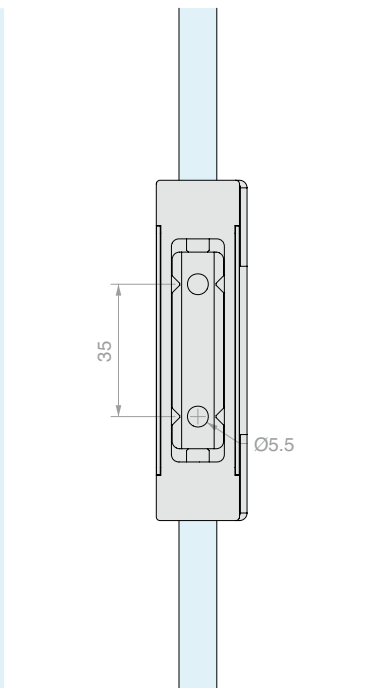
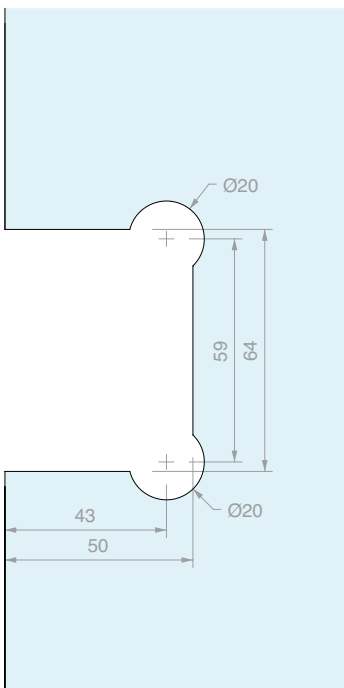
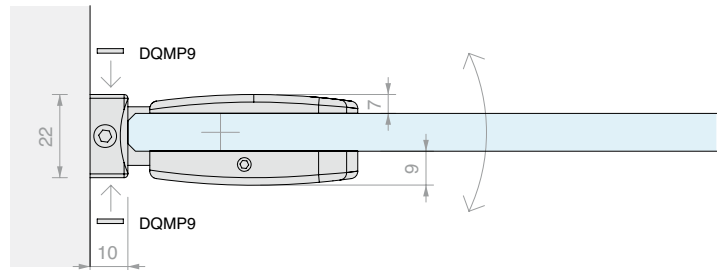

Art.	For glass	Qty
<b>CHD24</b>	From 8 to 12 mm	1 Pc



**WALL/GLASS ADJUSTABLE PIVOT HINGE FOR NARROW JAMBS**

Material: Brass  
 Finish: /1 /24  
 Spare plate DQMP9 on p. 306





8/12



MAX 900



56





CLOSING RETURN



±10° ADJUSTMENT



±90° ROTATION



NO VISIBLE SCREWS

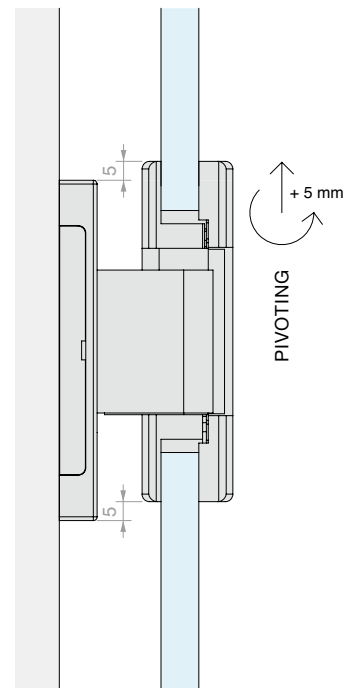
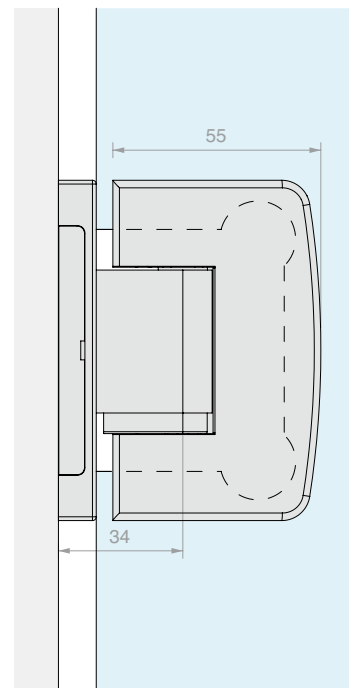
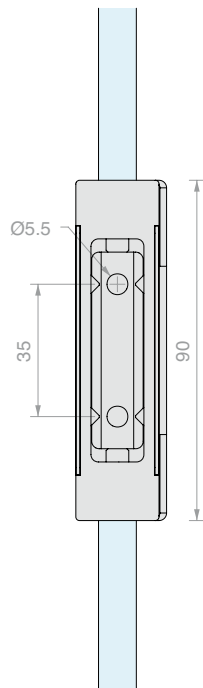
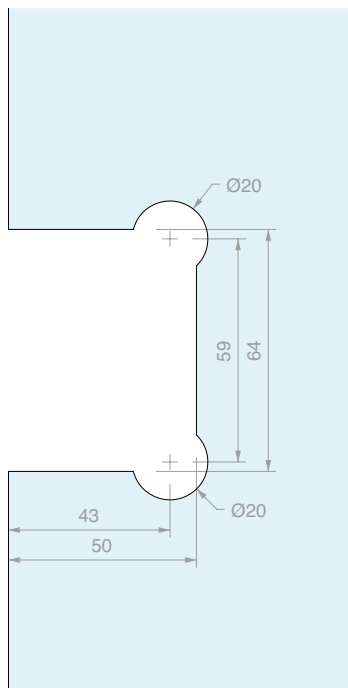
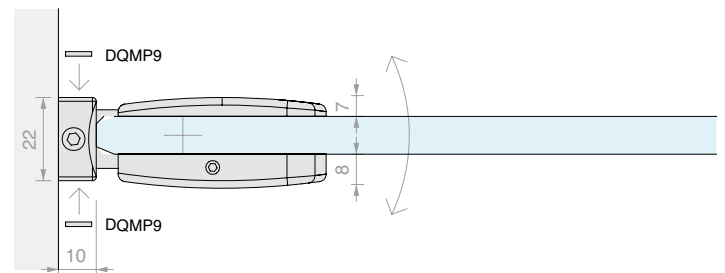

Art.  
**CHD24P**

For glass  
From 8 to 12 mm

Qty  
1 Pc



**GLASS/GLASS ADJUSTABLE  
IN-LINE HINGE**

Material: Brass  
Finish: /1 /2 /4 /24 /R2



8/12

MAX 900

56

CLOSING  
RETURN

±10° ADJUSTMENT

±90° ROTATION

NO VISIBLE  
SCREWS

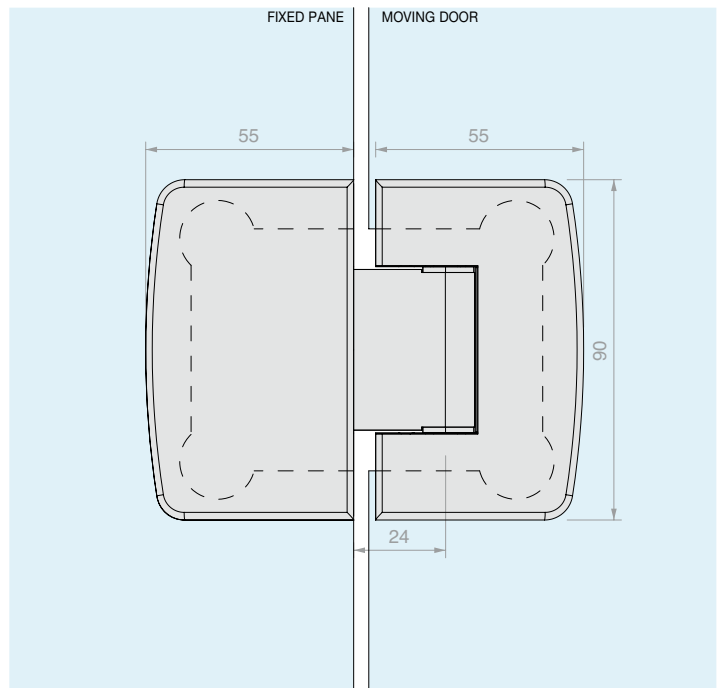
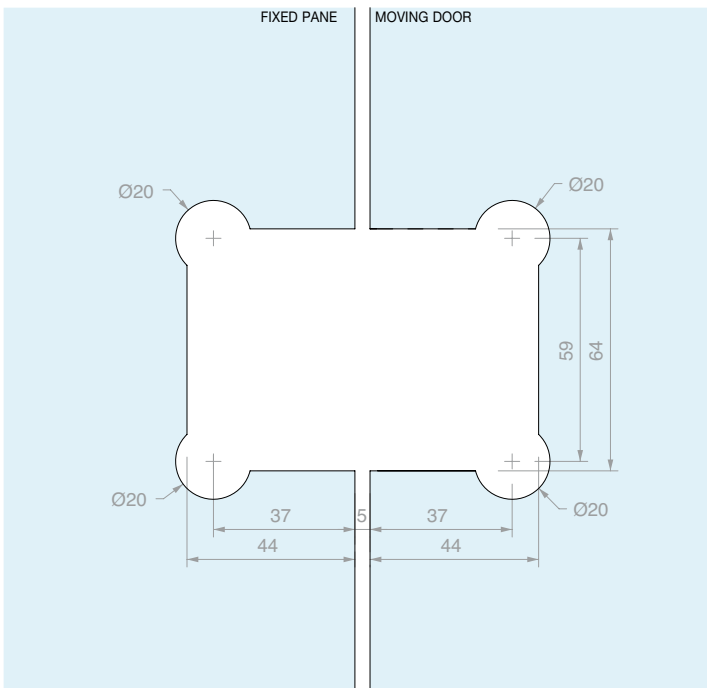
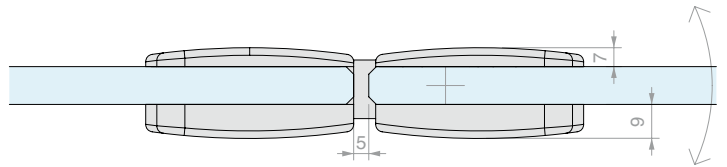

Art.  
**CHD280**

For glass  
From 8 to 12 mm

Qty  
1 Pc



**GLASS/GLASS IN-LINE  
ADJUSTABLE PIVOT HINGE**

Material: Brass

Finish: /1 /24





8/12



MAX  
900



56





CLOSING  
RETURN



±10° ADJUSTMENT



±90° ROTATION



NO VISIBLE  
SCREWS

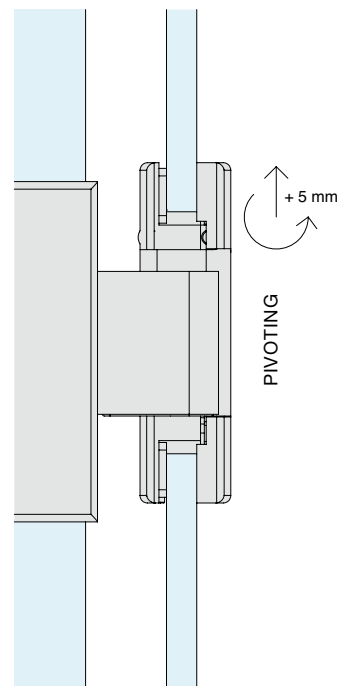
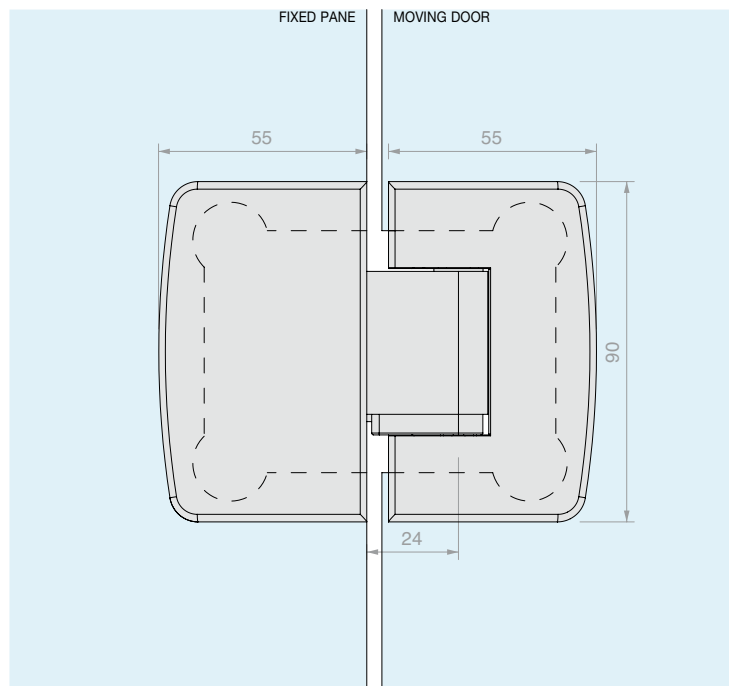
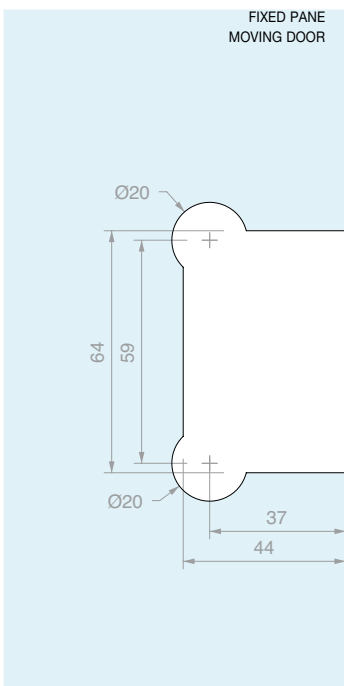
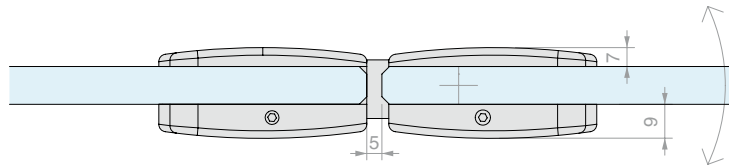

Art.  
**CHD280P**

For glass  
From 8 to 12 mm

Qty  
1 Pc



**GLASS/GLASS 90°  
ADJUSTABLE HINGE**

Material: Brass

Finish: /1 /24



8/12

MAX 900

56

CLOSING  
RETURN

±10° ADJUSTMENT

±90° ROTATION

NO VISIBLE  
SCREWS

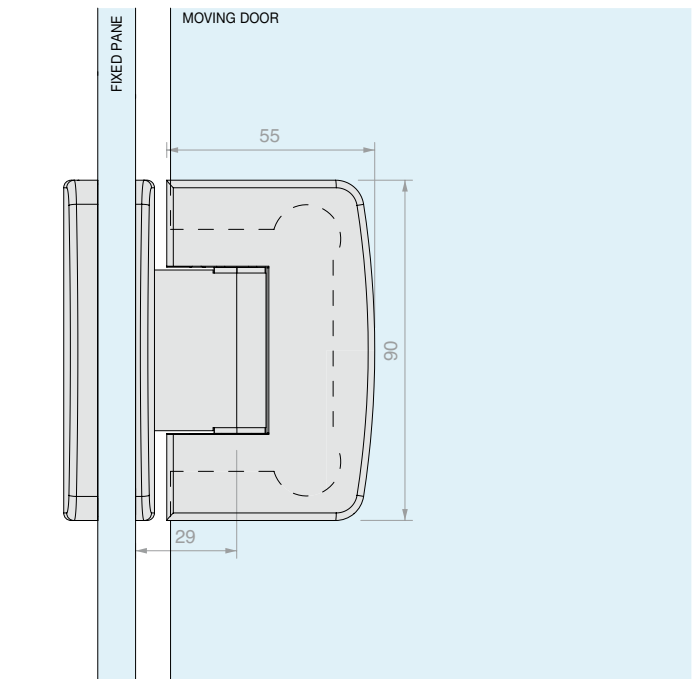
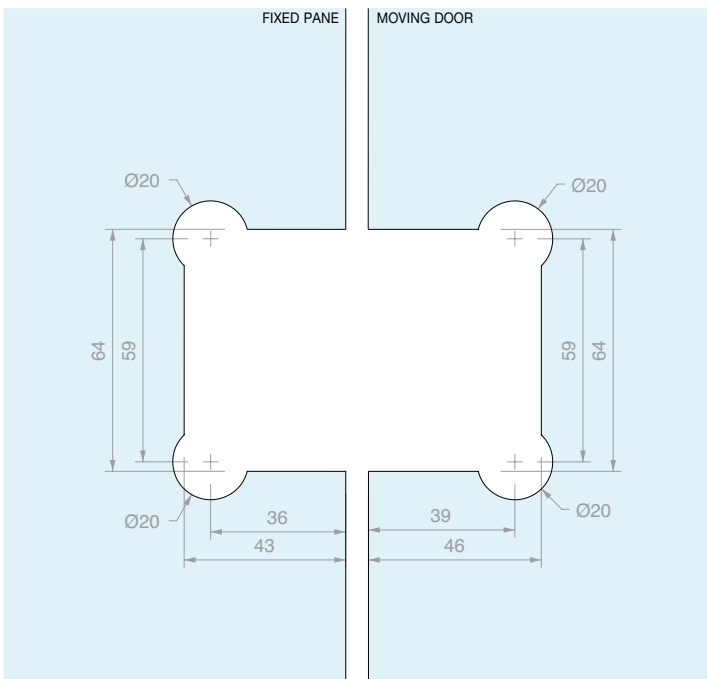
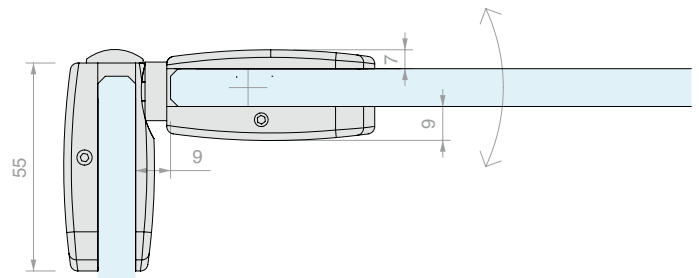

Art.  
**CHD290**

For glass  
From 8 to 12 mm

Qty  
1 Pc





**GLASS/GLASS 135°  
ADJUSTABLE HINGE**

Material: Brass

Finish: /1 /24



8/12

MAX 900

56

CLOSING RETURN

±10° ADJUSTMENT

±90° ROTATION

NO VISIBLE SCREWS

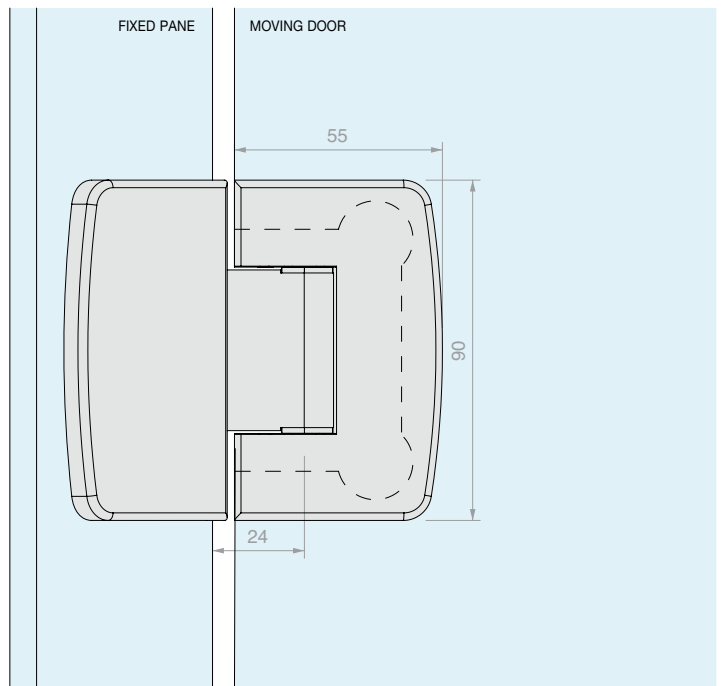
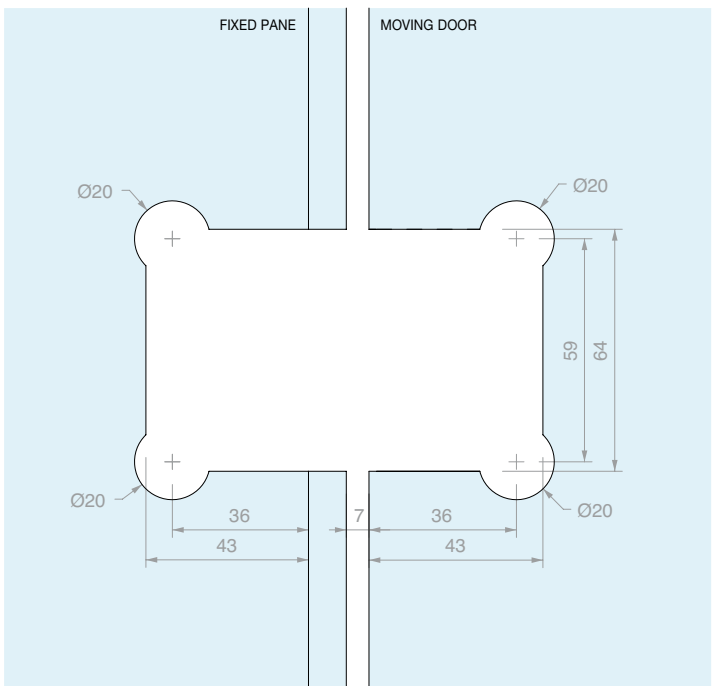
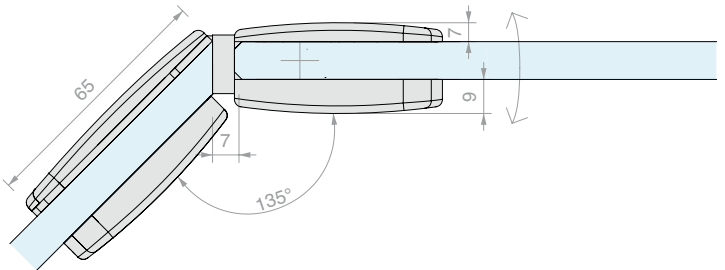
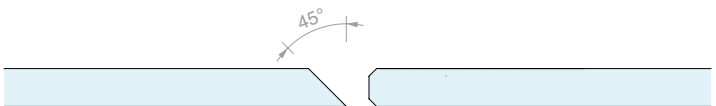

Art.  
**CHD2135**

For glass  
From 8 to 12 mm

Qty  
1 Pc



**CLOSURE WITH DOOR KNOB AND KEY LOCK**

Material: Brass  
Finish: /1 /2 /4 /24 /R2

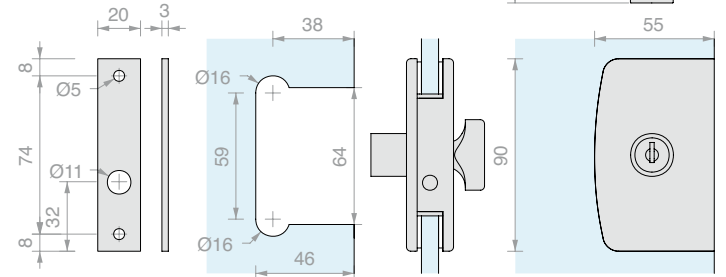

Art.	Pin	For glass	Key	Qty
<b>CSP75</b>	Ø7 L 16 mm	From 8 to 10 mm	Different	1 Pc



**CLOSURE WITH DOOR KNOB, KEY LOCK AND HANDLES**

Material: Brass  
Finish: /1 /24

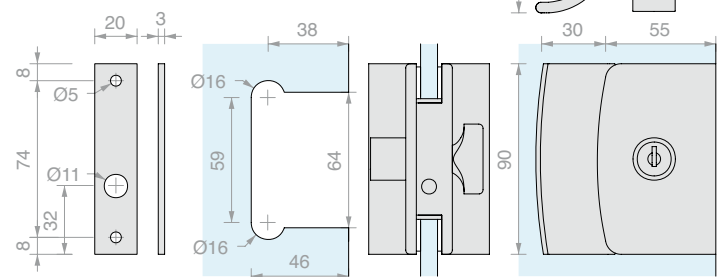

Art.	Pin	For glass	Key	Qty
<b>CSP85</b>	Ø7 L 16 mm	From 8 to 10 mm	Different	1 Pc

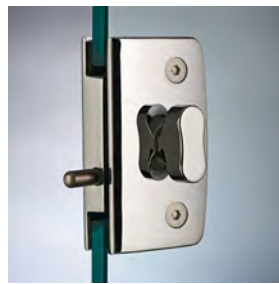

**LOCK WITH DOUBLE DOOR KNOB**

Material: Brass  
Finish: /1 /2 /4 /24 /R2

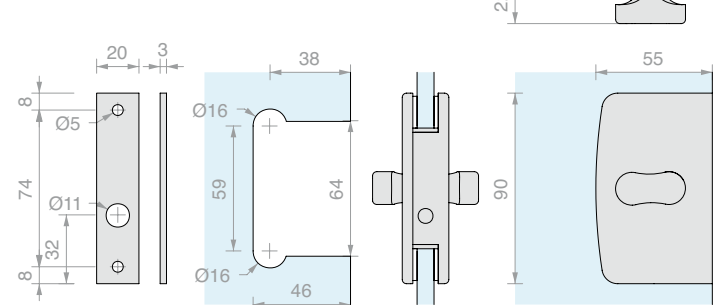

Art.	Pin	For glass	Qty
<b>CLP23</b>	Ø7 L 16 mm	From 8 to 10 mm	1 Pc



**CLOSURE WITH DOUBLE DOOR KNOB AND HANDLES**

Material: Brass  
Finish: /1 /24

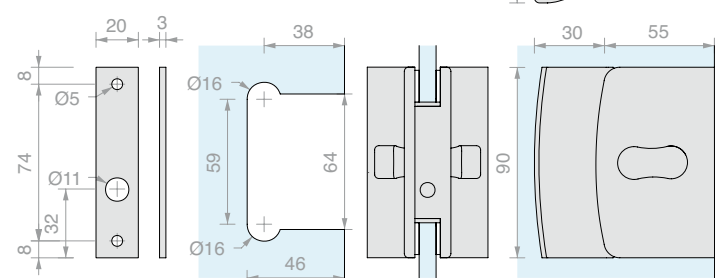

Art.	Pin	For glass	Qty
<b>CLPM29</b>	Ø7 L 16 mm	From 8 to 10 mm	1 Pc



**FREE/OCCUPIED CLOSURE WITH DOOR KNOB**

Material: Brass  
Finish: /1 /24

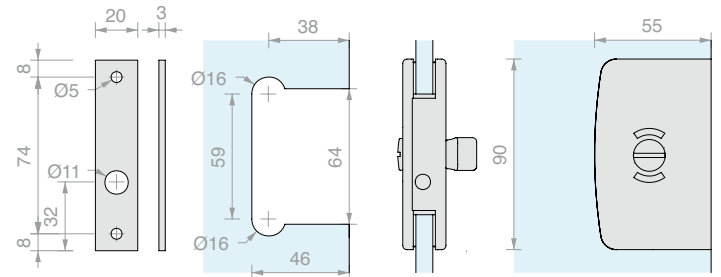

Art.	Pin	For glass	Qty
<b>CLS18</b>	Ø7 L 16 mm	From 8 to 10 mm	1 Pc



**FREE/OCCUPIED CLOSURE WITH DOOR KNOB AND HANDLES**

Material: Brass  
Finish: /1 /24

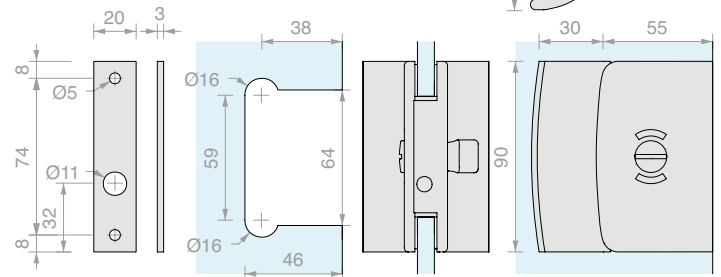

Art.	Pin	For glass	Qty
<b>CLM19</b>	Ø7 L 16 mm	From 8 to 10 mm	1 Pc



**STRIKE PLATE FOR GLASS**

Material: Brass  
Finish: /1 /2 /4 /24 /R2

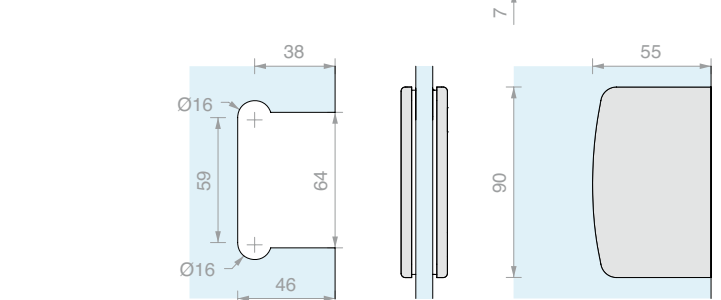

Art.	For glass	Qty
<b>CL105</b>	From 8 to 10 mm	1 Pc



**WALL/GLASS CLAMP FLUSH TO WALL**

Material: Brass  
 Invisible screws  
 Finish: /1 /2 /4 /24 /R2  
 Spare plate CHDMP4 on p. 306



Art.	For glass	Qty
<b>CHDM41</b>	From 6 to 12 mm	1 Pc

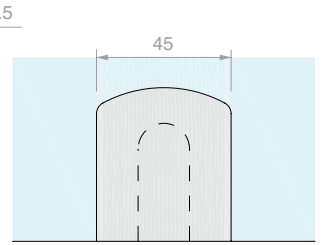
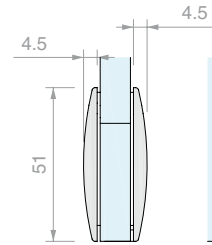
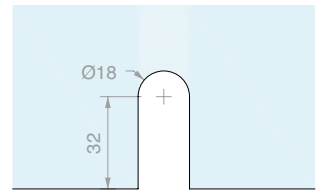

**WALL/GLASS CLAMP**

Material: Brass  
 Invisible screws  
 Finish: /1 /24  
 Spare plate CHDMP4 on p. 306



Art.	For glass	Qty
<b>CHDM43</b>	From 6 to 12 mm	1 Pc

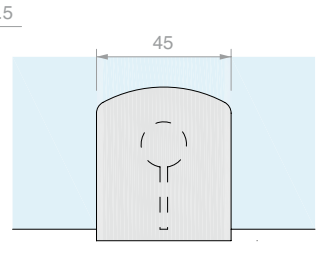
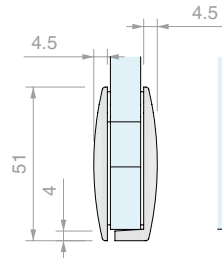
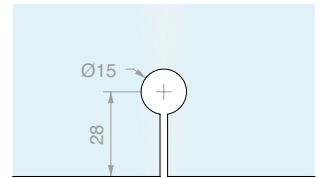

**WALL/GLASS SIDE FIXING CLAMP, NARROW**

Material: Brass  
 Invisible screws  
 Finish: /1 /24  
 Spare plate DQMP2 and CHDMP3 on p. 306

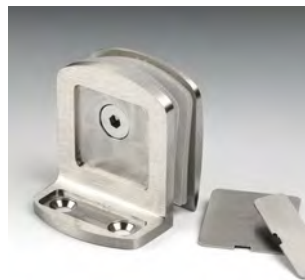

Art.	For glass	Qty
<b>CHDM57</b>	From 6 to 12 mm	1 Pc

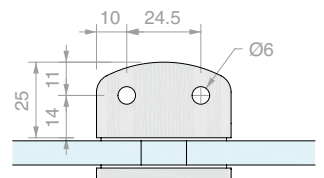
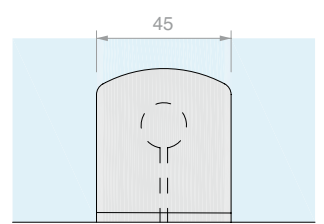
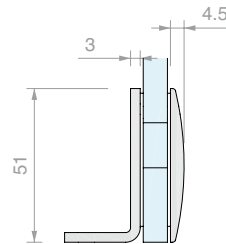
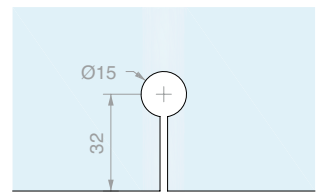



**WALL/GLASS SIDE FIXING CLAMP,  
LARGE**

Material: Brass  
Invisible screws  
Finish: /1 /24  
Spare plate DQMP2 on p. 306

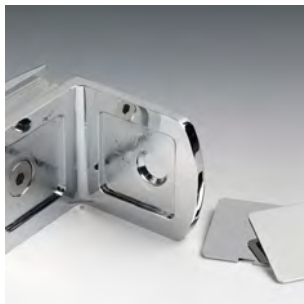

Art.	For glass	Qty
<b>CHDM52</b>	From 6 to 12 mm	1 Pc

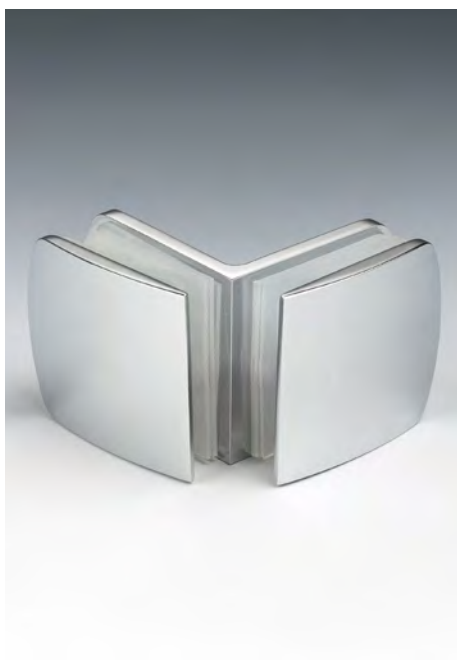
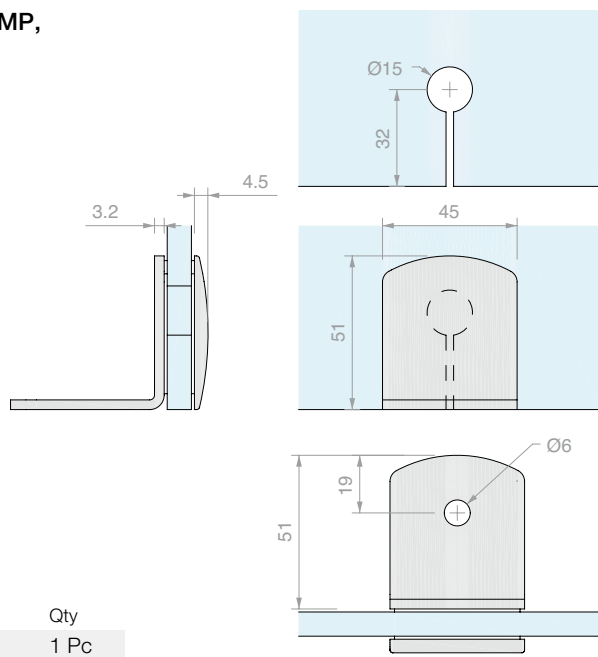

**GLASS/GLASS 90° CLAMP**

Material: Brass  
Invisible screws  
Finish: /1 /24  
Spare plate DQMP2 on p. 306



Art.	For glass	Qty
<b>CHDM47</b>	From 6 to 12 mm	1 Pc

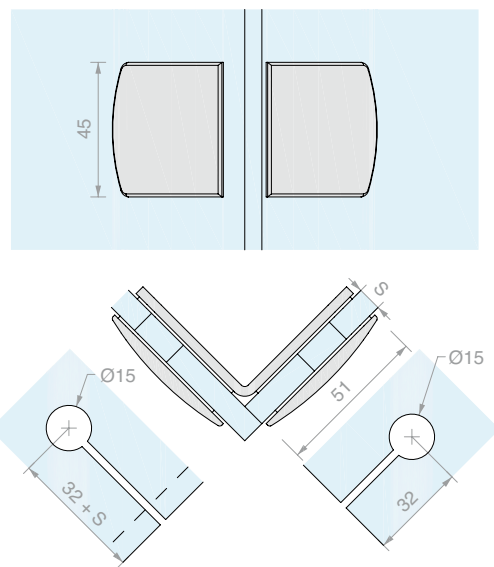

**GLASS/GLASS IN-LINE CLAMP**

Material: Brass  
Invisible screws  
Finish: /1 /24  
Spare plate DQMP2 on p. 306

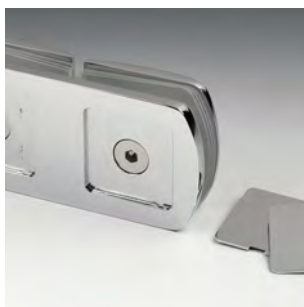

Art.	For glass	Qty
<b>CHDM45</b>	From 6 to 12 mm	1 Pc

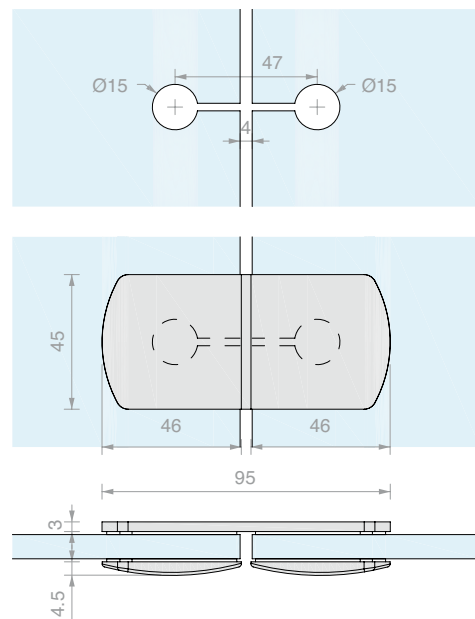

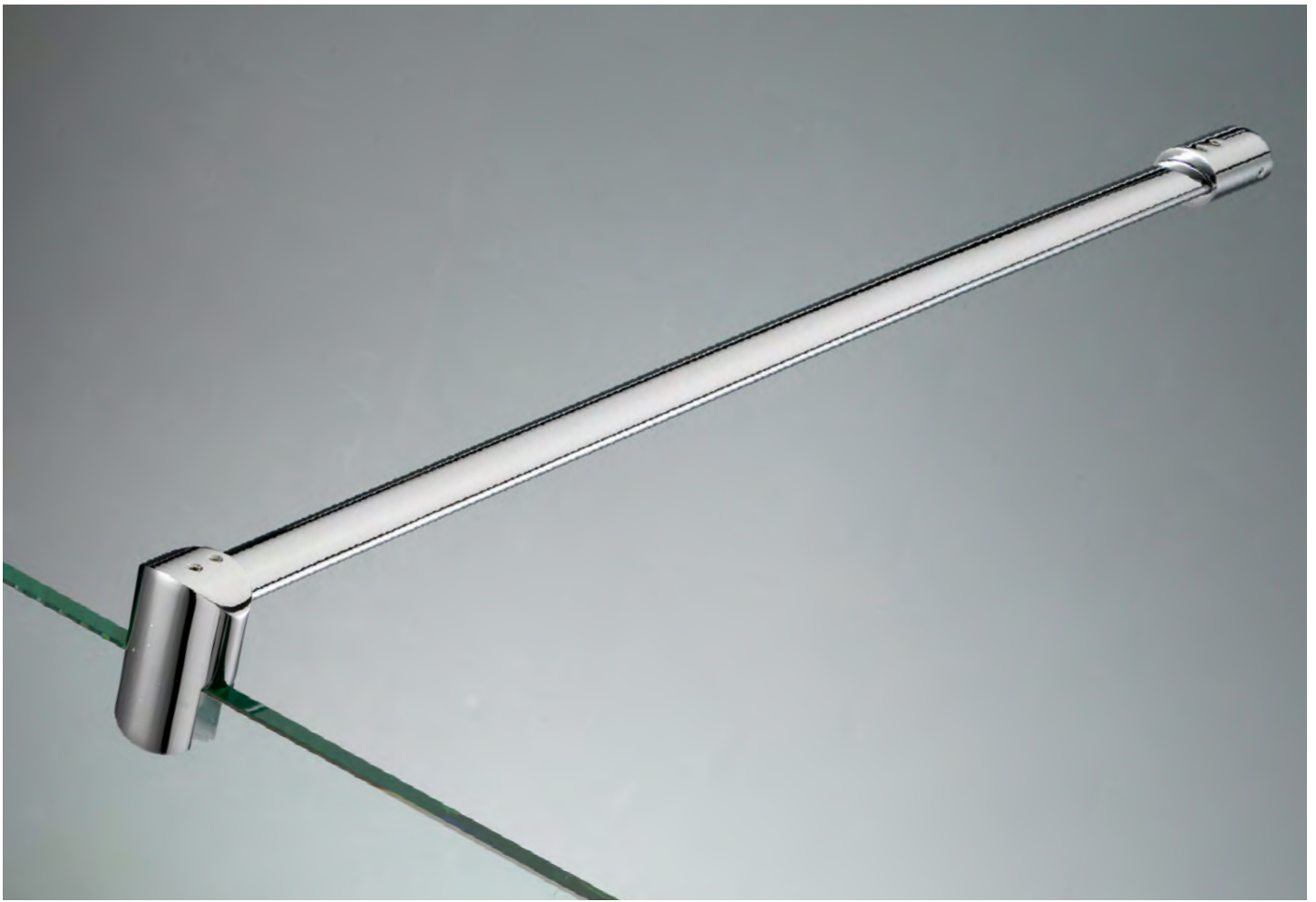

**FIXED WALL/GLASS STABILIZER BAR**

Material: Brass

Finish: /1 /2 /4 /24 /R2

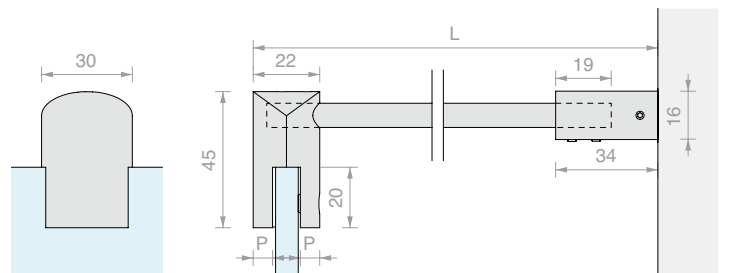

Art.	L	P	For glass	Qty
<b>CHDT500</b>	520 mm	6.5 mm	From 6 to 8 mm	1 Pc
<b>CHDT1000</b>	1020 mm	6.5 mm	From 6 to 8 mm	1 Pc
<b>CHDT1500</b>	1520 mm	6.5 mm	From 6 to 8 mm	1 Pc
<b>CHDT500G</b>	520 mm	4.5 mm	From 10 to 12 mm	1 Pc
<b>CHDT1000G</b>	1020 mm	4.5 mm	From 10 to 12 mm	1 Pc
<b>CHDT1500G</b>	1520 mm	4.5 mm	From 10 to 12 mm	1 Pc



**WALL/GLASS STABILIZER BAR WITH WALL JOINT**

Material: Brass

Finish: /1 /2 /4 /24 /R2

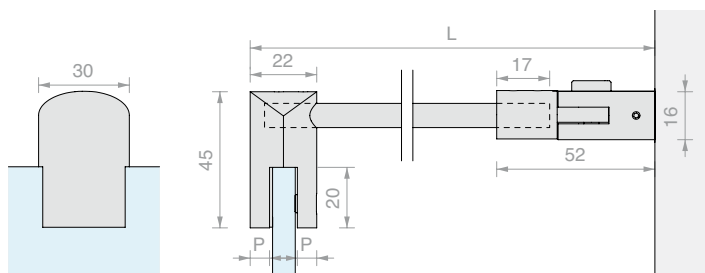

Art.	L	P	For glass	Qty
<b>CHDA500</b>	540 mm	6.5 mm	From 6 to 8 mm	1 Pc
<b>CHDA1000</b>	1040 mm	6.5 mm	From 6 to 8 mm	1 Pc
<b>CHDA1500</b>	1540 mm	6.5 mm	From 6 to 8 mm	1 Pc
<b>CHDA500G</b>	540 mm	4.5 mm	From 10 to 12 mm	1 Pc
<b>CHDA1000G</b>	1040 mm	4.5 mm	From 10 to 12 mm	1 Pc
<b>CHDA1500G</b>	1540 mm	4.5 mm	From 10 to 12 mm	1 Pc

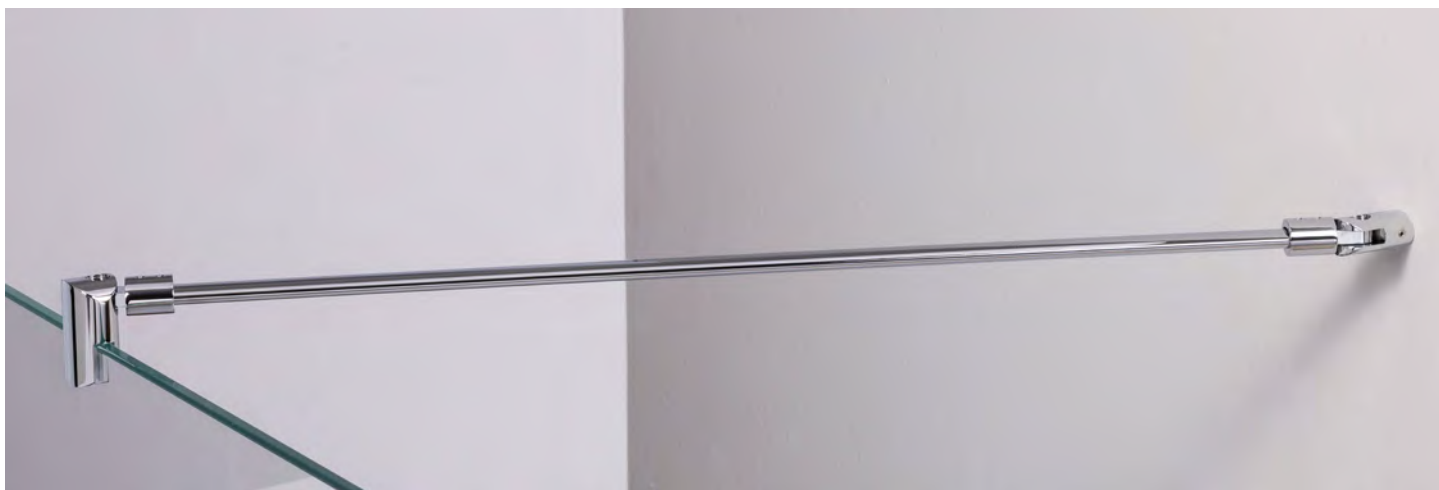

**WALL/GLASS STABILIZER BAR WITH DOUBLE JOINT**

Material: Brass

Finish: /1 /2 /4 /24 /R2

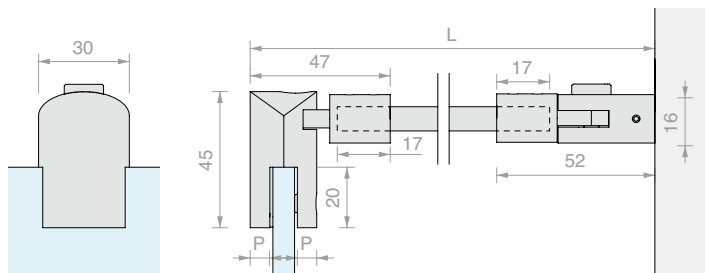
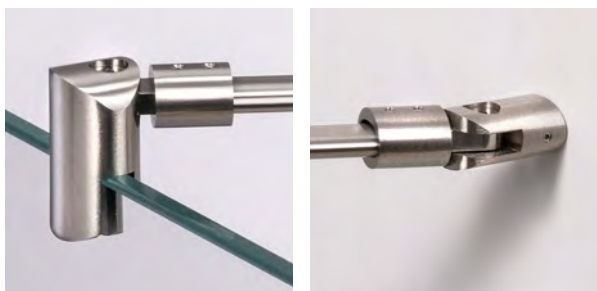

Art.	L	P	For glass	Qty
<b>CHDA55</b>	564 mm	6.5 mm	From 6 to 8 mm	1 Pc
<b>CHDA65</b>	1064 mm	6.5 mm	From 6 to 8 mm	1 Pc
<b>CHDA75</b>	1564 mm	6.5 mm	From 6 to 8 mm	1 Pc
<b>CHDA55G</b>	564 mm	4.5 mm	From 10 to 12 mm	1 Pc
<b>CHDA65G</b>	1064 mm	4.5 mm	From 10 to 12 mm	1 Pc
<b>CHDA75G</b>	1564 mm	4.5 mm	From 10 to 12 mm	1 Pc



**ELLIPTICAL BAR**

Material: Brass

Finish: /1 /2 /4 /24 /R2

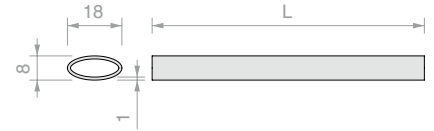

Art.	L	Qty
<b>CHDA05</b>	500 mm	1 Pc
<b>CHDA06</b>	1000 mm	1 Pc
<b>CHDA08</b>	1500 mm	1 Pc



**IN-LINE THROUGH GLASS FIXING**

Material: Brass

Finish: /1 /24

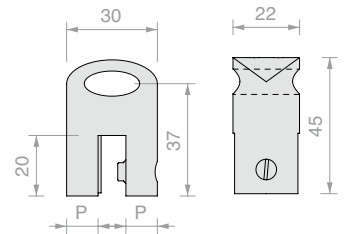

Art.	P	For glass	Qty
<b>CHDA83</b>	6.5 mm	From 6 to 8 mm	1 Pc
<b>CHDA831</b>	4.5 mm	From 10 to 12 mm	1 Pc



**ARTICULATED GLASS FIXING**

Material: Brass

Finish: /1 /2 /4 /24 /R2

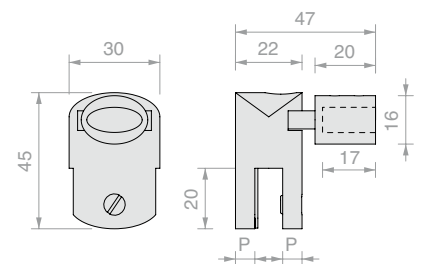

Art.	P	For glass	Qty
<b>CHDA85</b>	6.5 mm	From 6 to 8 mm	1 Pc
<b>CHDA851</b>	4.5 mm	From 10 to 12 mm	1 Pc





**CLOSED GLASS FIXING**

Material: Brass

Finish: /1 /2 /4 /24 /R2

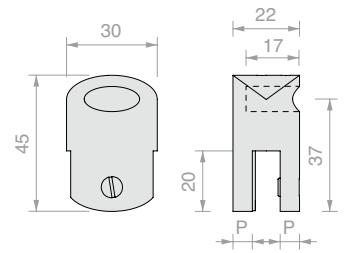

Art.	P	For glass	Qty
<b>CHDA86</b>	6.5 mm	From 6 to 8 mm	1 Pc
<b>CHDA861</b>	4.5 mm	From 10 to 12 mm	1 Pc



**ARTICULATED DISTANCED GLASS FIXING**

Material: Brass

Finish: /1 /2 /4 /24 /R2

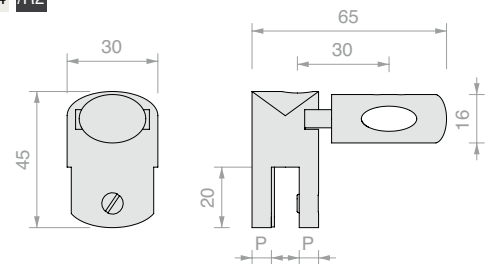

Art.	P	For glass	Qty
<b>CHDA90</b>	6.5 mm	From 6 to 8 mm	1 Pc
<b>CHDA901</b>	4.5 mm	From 10 to 12 mm	1 Pc



**WALL FIXING**

Material: Brass

Finish: /1 /2 /4 /24 /R2

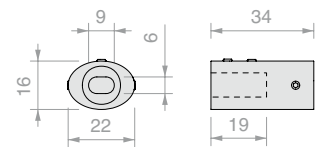

Art.	Qty
<b>CHDA93</b>	1 Pc



**ARTICULATED WALL FIXING**

Material: Brass

Finish: /1 /2 /4 /24 /R2

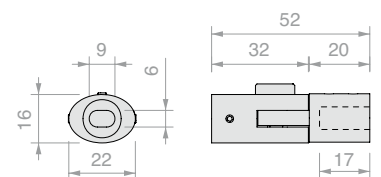

Art.	Qty
<b>CHDA88</b>	1 Pc



**SPARE PLATE DQMP2**

Material: Brass  
 Finish: /1 /2 /4 /24 /R2

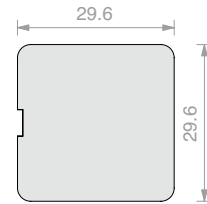

Art.	Qty
<b>DQMP2</b>	1 Pc

**SPARE PLATE DQMP9**

Material: AISI 304 steel  
 Finish: /2 /8 /15 /R2

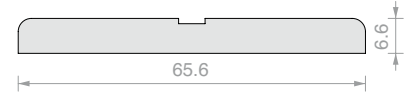

Art.	Qty
<b>DQMP9</b>	1 Pc

**SPARE PLATE CHDMP4**

Material: Brass  
 Finish: /1 /2 /4 /24 /R2

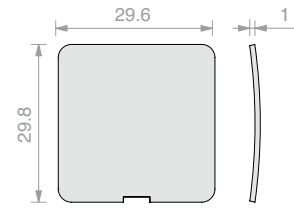

Art.	Qty
<b>CHDMP4</b>	1 Pc

**SPARE PLATE CHDMP3**

Material: Brass  
 Finish: /1 /24

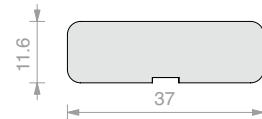

Art.	Qty
<b>CHDMP3</b>	1 Pc

**SPARE PLATE CHDMP1**

Material: Brass  
 Finish: /1 /2 /4 /24 /R2

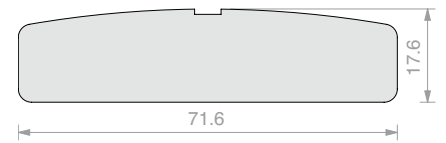

Art.	Qty
<b>CHDMP1</b>	1 Pc

**SPARE PLATE CHDMP2**

Material: Brass  
 Finish: /1 /2 /4 /24 /R2

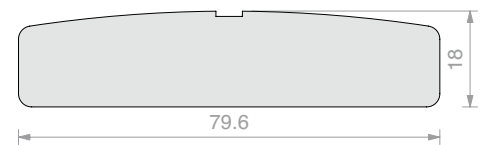

Art.	Qty
<b>CHDMP2</b>	1 Pc



**PAIR OF KNOBS WITH GRIP SP2255**

Material: Brass  
 Recommended glass hole minimum size Ø8 mm  
 Finish: /1 /2 /4 /24 /R2

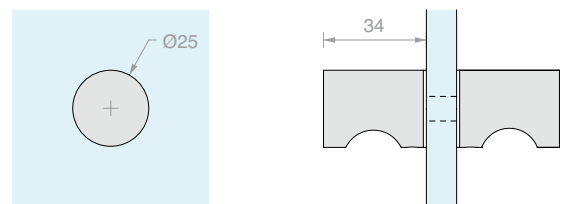

Art.	For glass	Qty
<b>SP2255</b>	From 6 to 12 mm	1 Pc

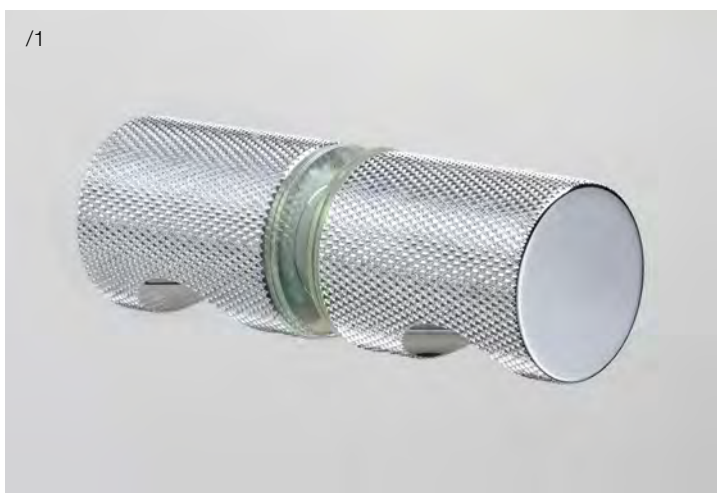

**PAIR OF KNURLED KNOBS WITH GRIP SP2255GD**

Material: Brass  
 Recommended glass hole minimum size Ø8 mm  
 Finish: /1 /2 /4 /24 /R2

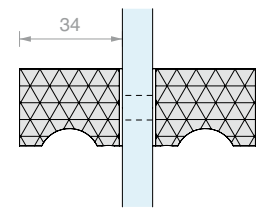
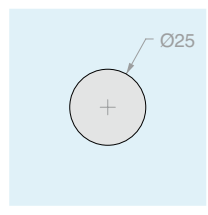

Art.	For glass	Qty
<b>SP2255GD</b>	From 6 to 12 mm	1 Pc

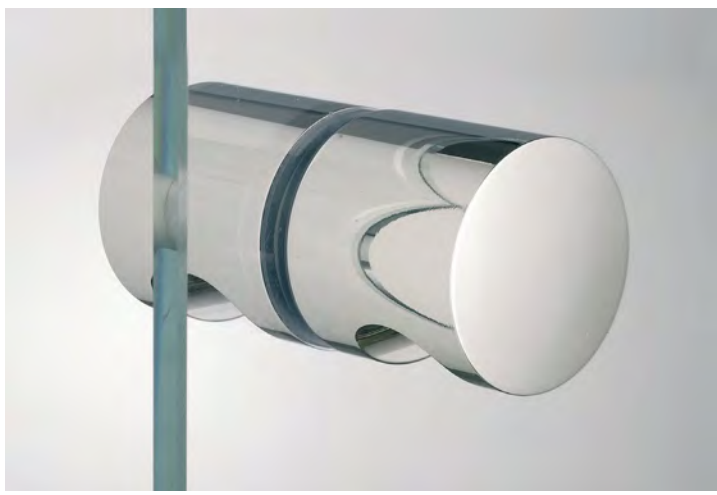

**PAIR OF KNOBS WITH GRIP SP255**

Material: Brass  
 Recommended glass hole minimum size Ø8 mm  
 Finish: /1 /2 /4 /24 /R2

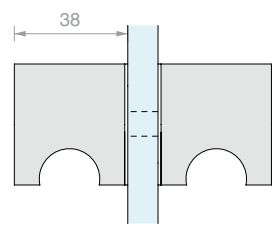
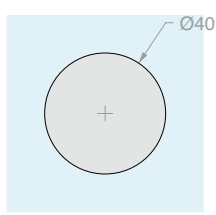

Art.	For glass	Qty
<b>SP255</b>	From 8 to 14 mm	1 Pc

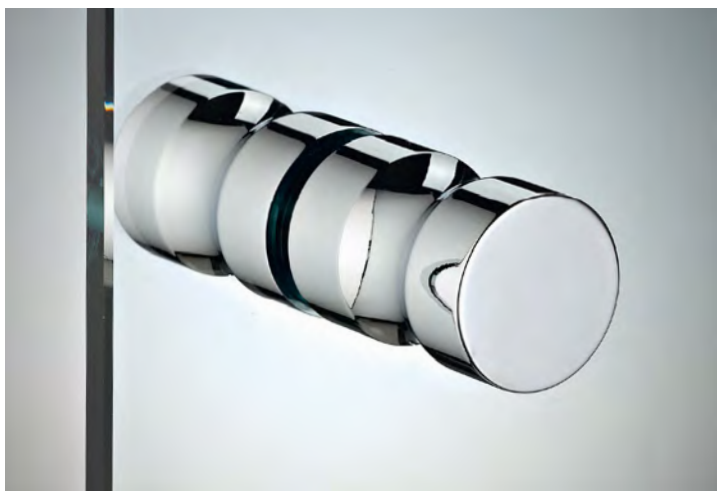

**PAIR OF KNOBS WITH GRIP VETCIL35**

Material: Brass  
 Recommended glass hole minimum size Ø10 mm  
 Finish: /1 /2 /3

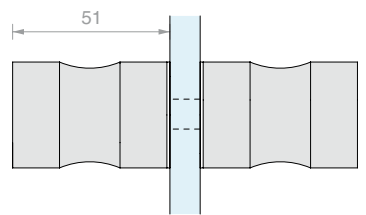
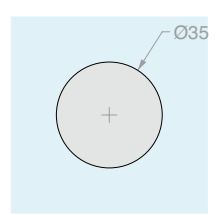

Art.	For glass	Qty
<b>VETCIL35</b>	From 8 to 12 mm	1 Pc

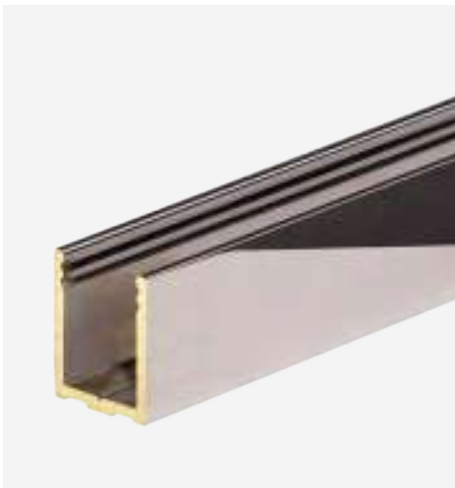

**LMU20B U-SHAPED PROFILE**

Material: Brass

Finish: /1 /2 /4 /24 /R2

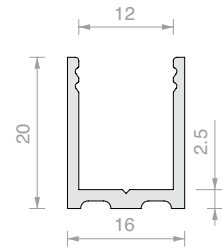

Art.	Length	Qty
<b>LMU20B.150</b>	1498 mm	1 Pc
<b>LMU20B.220</b>	2200 mm	1 Pc
<b>LMU20B.300</b>	3000 mm	1 Pc



**LMU86B FLAT UPPER PROFILE**

Material: Brass

Finish: /1 /2 /4 /24 /R2

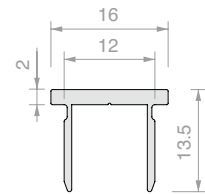

Art.	Length	Qty
<b>LMU86B.100</b>	992 mm	1 Pc
<b>LMU86B.150</b>	1498 mm	1 Pc
<b>LMU86B.300</b>	3000 mm	1 Pc



**FLAT CAP LMUB**

Material: Brass

Finish: /1 /2 /4 /24 /R2

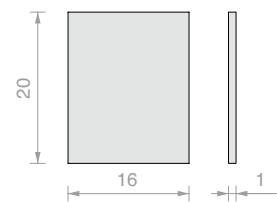

Art.	Qty
<b>LMU20TPB</b>	1 Pc



**WATER BARRIER PROFILE PESQ0810B**

Material: Brass

Finish: /1 /2 /4 /24 /R2

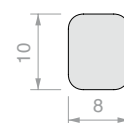

Art.	Length	Qty
<b>PESQ0810B.100</b>	992 mm	1 Pc
<b>PESQ0810B.150</b>	1498 mm	1 Pc
<b>PESQ0810B.300</b>	3000 mm	1 Pc

**PBD3183 U-SHAPED PROFILE**

Material: Aluminium

Finish: /6 /88 /91 /97

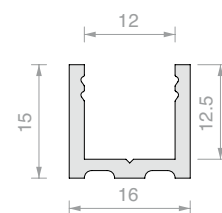

Art.	Length	Qty
<b>PBD3183.150</b>	1498 mm	1 Pc
<b>PBD3183.220</b>	2200 mm	1 Pc
<b>PBD3183</b>	3000 mm	1 Pc

**ROUNDED UPPER PROFILE PBD3184**

Material: Aluminium

Finish: /6 /88 /91 /97

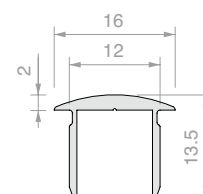

Art.	Length	Qty
<b>PBD3184.100</b>	992 mm	1 Pc
<b>PBD3184.150</b>	1498 mm	1 Pc
<b>PBD3184</b>	3000 mm	1 Pc

**ROUNDED CAP PBD**

Material: Aluminium

Finish: /6 /88 /91 /97

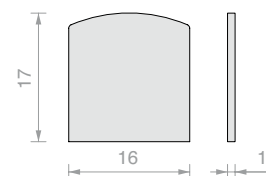

Art.	Qty
<b>PBDTP</b>	1 Pc

**FLAT UPPER PROFILE PBD3186**

Material: Aluminium

Finish: /6 /88 /91 /97

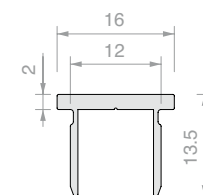

Art.	Length	Qty
<b>PBD3186.100</b>	992 mm	1 Pc
<b>PBD3186.150</b>	1498 mm	1 Pc
<b>PBD3186</b>	3000 mm	1 Pc

**PBD FLAT CAP**

Material: Aluminium

Finish: /6 /88 /91 /97

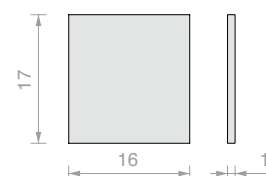

Art.	Qty
<b>PBD86TP</b>	1 Pc



**BALLOON GASKET**

Material: Co-extruded rigid and soft PVC  
 Resistant to UV rays  
 Fungicide to prevent mould from forming  
 Maximum operating temperature 70°C  
 Colour: transparent, transparent balloon

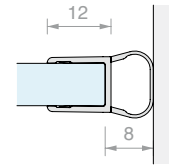

Art.	Length	For glass	Qty
<b>GM62</b>	2200 mm	From 6 to 8 mm	1 Pc
<b>GM6225</b>	2500 mm	From 6 to 8 mm	1 Pc
<b>GM6230</b>	3000 mm	From 6 to 8 mm	1 Pc

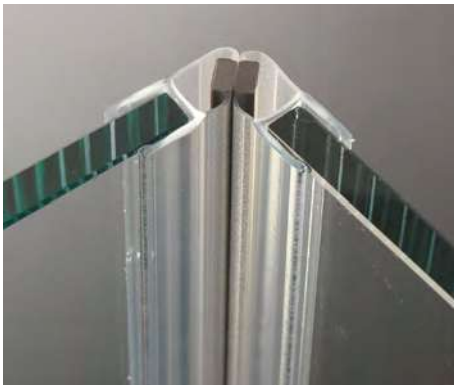

**MAGNETIC 45° GASKET**

Material: Co-extruded rigid and soft PVC  
 Maximum operating temperature 70°C  
 Colour: transparent, embossed balloon, grey magnet

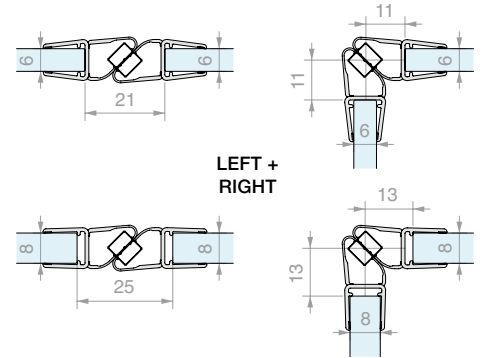

Art.	Length	For glass	Qty
<b>GM12DX20</b>	2000 mm	From 6 to 8 mm	1 Pc
<b>GM12DX22</b>	2200 mm	From 6 to 8 mm	1 Pc
<b>GM12DX25</b>	2500 mm	From 6 to 8 mm	1 Pc
<b>GM12SX20</b>	2000 mm	From 6 to 8 mm	1 Pc
<b>GM12SX22</b>	2200 mm	From 6 to 8 mm	1 Pc
<b>GM12SX25</b>	2500 mm	From 6 to 8 mm	1 Pc



**90° STRIKE JAMB GASKET**

Material: Co-extruded rigid and soft PVC  
 Resistant to UV rays  
 Fungicide to prevent mould from forming  
 Maximum operating temperature 70°C  
 Colour: transparent/\*black, embossed lip

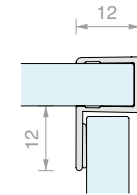

Art.	Length	For glass	Qty
<b>GM58</b>	2200 mm	From 6 to 8 mm	1 Pc
<b>GM58NR*</b>	2200 mm	From 6 to 8 mm	1 Pc
<b>GM5830</b>	3000 mm	From 6 to 8 mm	1 Pc

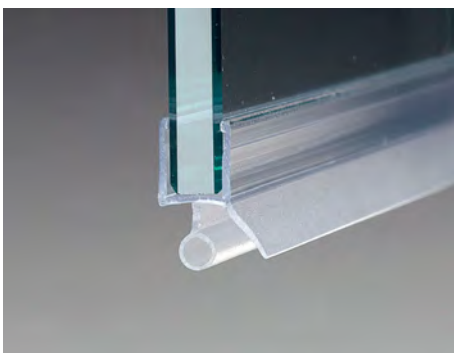

**GASKET WITH BALLOON WATER BARRIER AND DRIP FLAP**

Material: Co-extruded rigid and soft PVC  
 Resistant to UV rays  
 Fungicide to prevent mould from forming  
 Maximum operating temperature 70°C  
 Colour: transparent, embossed lip and balloon

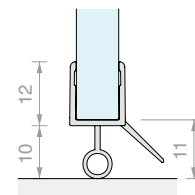

Art.	Length	For glass	Qty
<b>GM6010</b>	1000 mm	From 6 to 8 mm	1 Pc
<b>GM6020</b>	2000 mm	From 6 to 8 mm	1 Pc
<b>GM6025</b>	2500 mm	From 6 to 8 mm	1 Pc
<b>GM6030</b>	3000 mm	From 6 to 8 mm	1 Pc

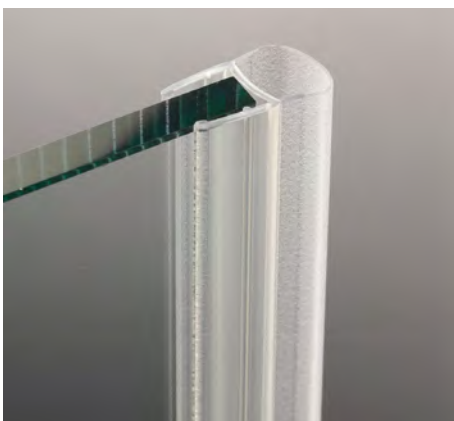

**BALLOON GASKET**

Material: Co-extruded rigid and soft PVC  
 Resistant to UV rays  
 Fungicide to prevent mould from forming  
 Colour: transparent/\*black, embossed balloon

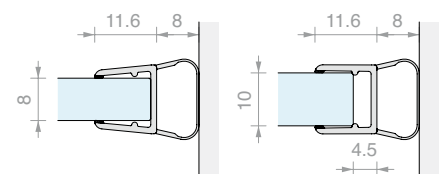

Art.	Length	For glass	Qty
<b>GM06</b>	2000 mm	From 8 to 10 mm	1 Pc
<b>GM0622</b>	2200 mm	From 8 to 10 mm	1 Pc
<b>GM0622NR*</b>	2200 mm	From 8 to 10 mm	1 Pc
<b>GM0625</b>	2500 mm	From 8 to 10 mm	1 Pc
<b>GM0625NR*</b>	2500 mm	From 8 to 10 mm	1 Pc
<b>GM063000</b>	3000 mm	From 8 to 10 mm	1 Pc
<b>GM063000NR*</b>	3000 mm	From 8 to 10 mm	1 Pc

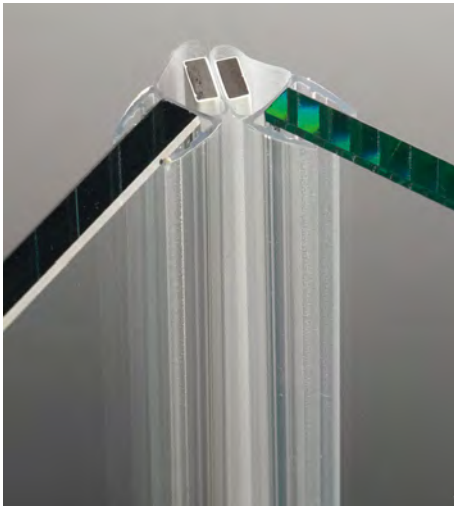
**MAGNETIC 45° GASKET**

Material: Co-extruded rigid and soft PVC  
 Resistant to UV rays  
 Fungicide to prevent mould from forming  
 Maximum operating temperature 70°C  
 Colour: transparent/\*black, transparent balloon, white/\*black magnet

Art.	Length	For glass	Qty
<b>GM1520SX</b>	2200 mm	From 8 to 10 mm	1 Pc
<b>GM1520SXNR*</b>	2200 mm	From 8 to 10 mm	1 Pc
<b>GM1520DX</b>	2200 mm	From 8 to 10 mm	1 Pc
<b>GM1520DXNR*</b>	2200 mm	From 8 to 10 mm	1 Pc
<b>GM15SX</b>	2500 mm	From 8 to 10 mm	1 Pc
<b>GM15DX</b>	2500 mm	From 8 to 10 mm	1 Pc
<b>GM1530SX</b>	3000 mm	From 8 to 10 mm	1 Pc
<b>GM1530DX</b>	3000 mm	From 8 to 10 mm	1 Pc

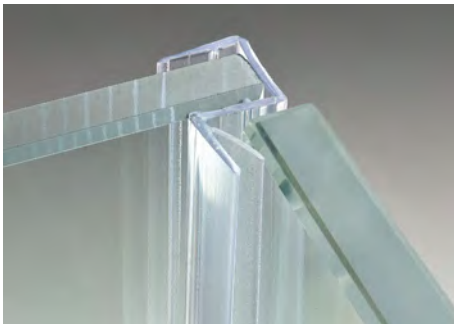
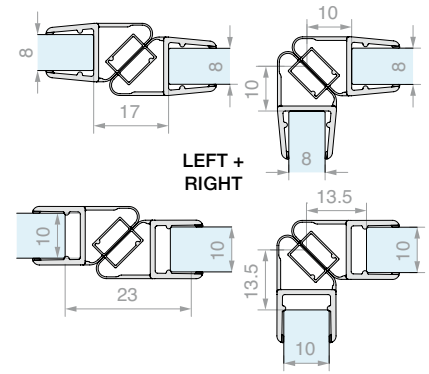
**90° STRIKE JAMB GASKET**

Material: Co-extruded rigid and soft PVC  
 Resistant to UV rays  
 Fungicide to prevent mould from forming  
 Maximum operating temperature 70°C  
 Colour: transparent, embossed lip

Art.	Length	For glass	Qty
<b>GM5422</b>	2200 mm	From 8 to 10 mm	1 Pc
<b>GM5430</b>	3000 mm	From 8 to 10 mm	1 Pc

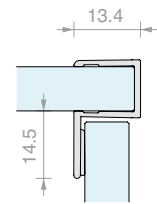
**GASKET WITH LIP WATER BARRIER AND DRIP FLAP**

Material: Co-extruded rigid and soft PVC  
 Resistant to UV rays  
 Fungicide to prevent mould from forming  
 Maximum operating temperature 70°C  
 Colour: transparent/\*black, embossed lip

Art.	Length	For glass	Qty
<b>GM0210</b>	1000 mm	From 8 to 10 mm	1 Pc
<b>GM02</b>	2000 mm	From 8 to 10 mm	1 Pc
<b>GM02NR*</b>	2000 mm	From 8 to 10 mm	1 Pc
<b>GM022500</b>	2500 mm	From 8 to 10 mm	1 Pc
<b>GM022500NR*</b>	2500 mm	From 8 to 10 mm	1 Pc

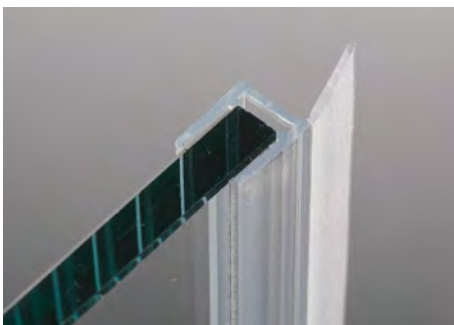
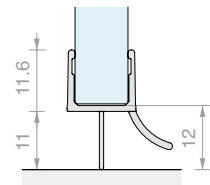
**GASKET WITH STRAIGHT LIP**

Material: Co-extruded rigid and soft PVC  
 Fungicide to prevent mould from forming  
 Colour: transparent, embossed lip

Art.	Length	For glass	Qty
<b>GM04</b>	2000 mm	From 8 to 10 mm	1 Pc
<b>GM0422</b>	2200 mm	From 8 to 10 mm	1 Pc
<b>GM0425</b>	2500 mm	From 8 to 10 mm	1 Pc
<b>GM0430</b>	3000 mm	From 8 to 10 mm	1 Pc

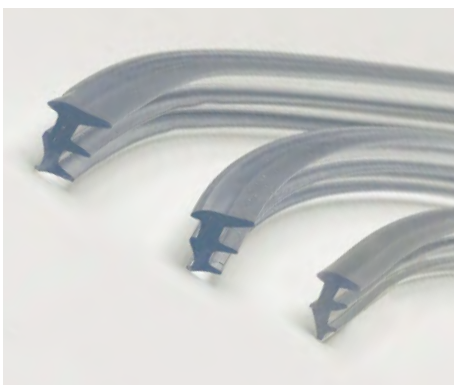
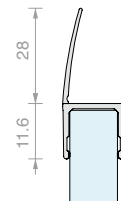
**GLASS HOLDER GASKET**

Material: PVC

Art.	Thickness	Colour	Qty	Art.	Thickness	Colour	Qty
<b>GTUP2</b>	2	Transparent	1 m	<b>GTUP5G</b>	5	Embossed	1 m
<b>GTUP3</b>	3	Transparent	1 m	<b>GTUP6G</b>	6	Embossed	1 m
<b>GTUP4</b>	4	Transparent	1 m	<b>GTUP2N</b>	2	Black	1 m
<b>GTUP5</b>	5	Transparent	1 m	<b>GTUP3N</b>	3	Black	1 m
<b>GTUP6</b>	6	Transparent	1 m	<b>GTUP4N</b>	4	Black	1 m
<b>GTUP2G</b>	2	Embossed	1 m	<b>GTUP5N</b>	5	Black	1 m
<b>GTUP3G</b>	3	Embossed	1 m	<b>GTUP6N</b>	6	Black	1 m
<b>GTUP4G</b>	4	Embossed	1 m				

# CER

## *Design*

The classic that never goes out of style.  
The CER series guarantees familiarity and the security of a tested product that is always up to date.

The CER line also provides wide opportunities for customisation with the various available finishes.  
Adapting to glass from 6 to 10 mm thick, the range covers complete standard systems and allows for customisation due to the different combinations of hinges, clamps and knobs.

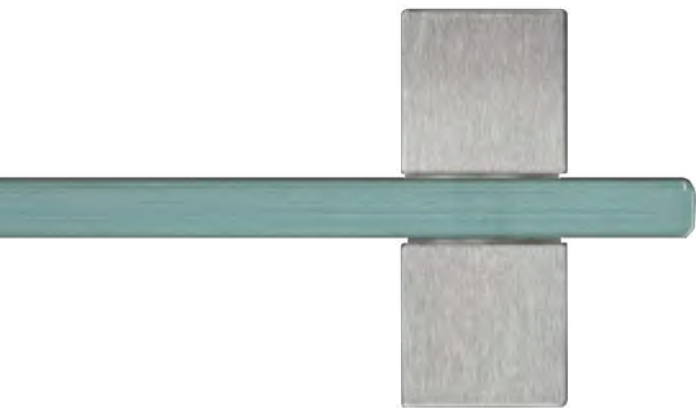



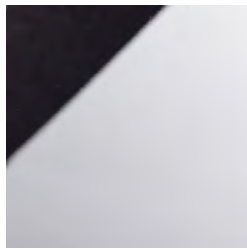

*/1*  
Chrome

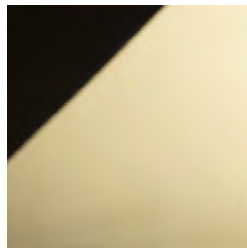

*/2*  
Gold



*/4*  
Bronze



*/3*  
Brushed nickel



# CER

## *CER Hinges*

CER hinges are the functional heart of the CER SERIES.

They are produced from brass bars. The accessories are made of AISI 304, while the brass joints coated internally with a self-lubricating plastic material, leading to greater durability.



Additional die-cut PVC seals for mounting glass with thickness from 6 to 10 mm.

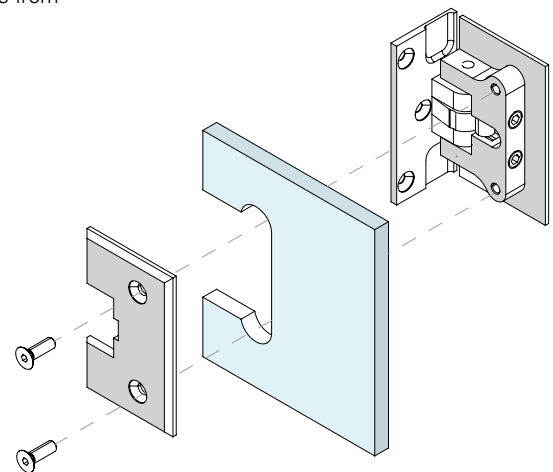

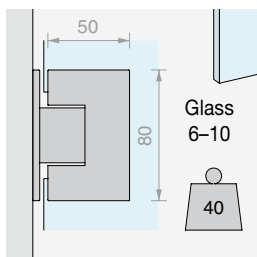
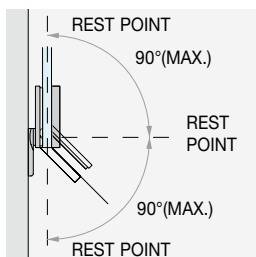
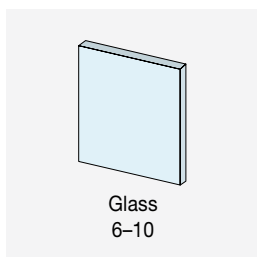

**ANGLE OF ROTATION**  
 Angle of rotation from +90° to -90°. With rest point at 0° and stops at -90° and +90°.

**VERSION FOR GLASS WITH THICKNESS FROM 6 TO 10 mm**

With a single model, doors with thickness from 6 to 10 mm can be made

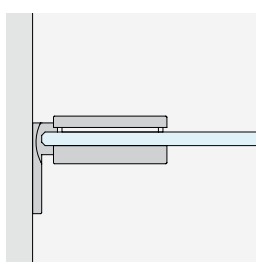

**WALL/GLASS**  
with side plate

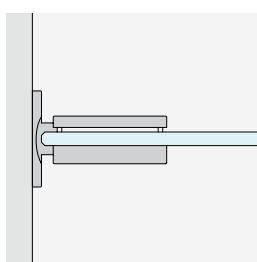

**WALL/GLASS**  
with central plate

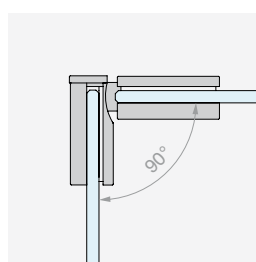

**GLASS/GLASS**  
90° corner

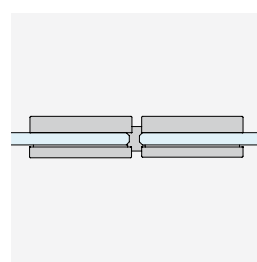

**GLASS/GLASS**  
in-line

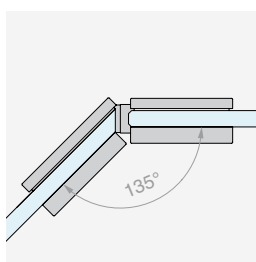

**GLASS/GLASS**  
135°

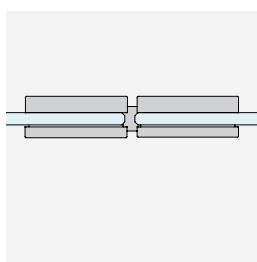

**GLASS/GLASS SAFETY**  
in-line

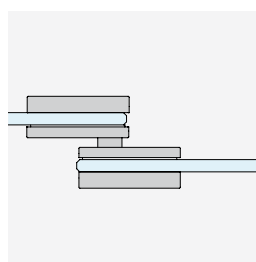

**GLASS/GLASS**  
overlapping in-line

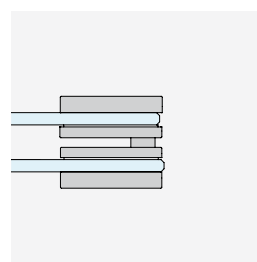

**GLASS/GLASS FREE**  
folding in-line



## CONFIGURATIONS WITH HINGED DOORS

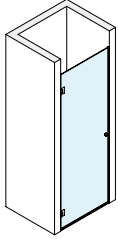

Page 318

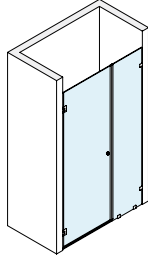

Page 320

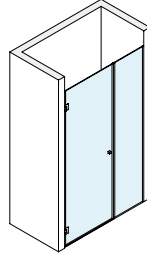

Page 322

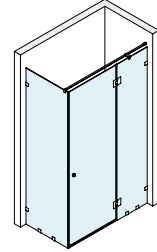

Page 324

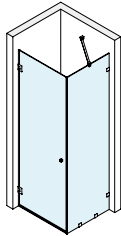

Page 326

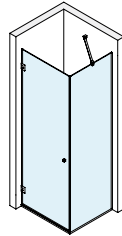

Page 328

## WALK-IN CONFIGURATIONS

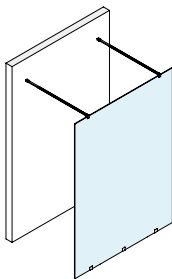

Page 331

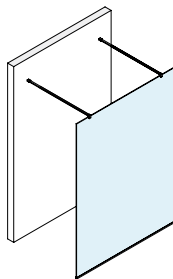

Page 333

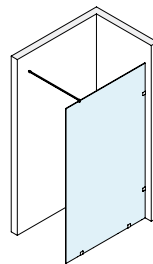

Page 335

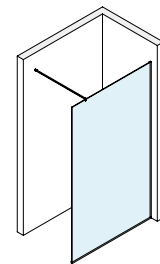

Page 337



**WALL/WALL HINGED SHOWER KIT**

Finish: /1 /2 /3 /4

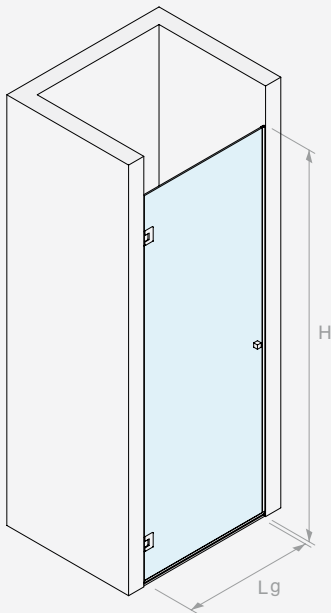
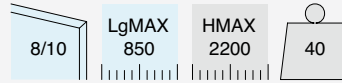

Kit comprising:

Art.	Description	Qty.
<b>CER26</b>	Side hinge	2 Pcs
<b>PESQ0810B.100</b>	Water barrier profile	1 Pc
<b>GM0210</b>	Gasket with drip flap	1 Pc
<b>GM0622</b>	Balloon gasket	2 Pcs
<b>DQP2525</b>	Pair of knobs	1 Pc

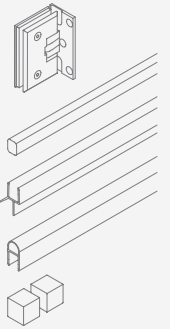

Art.	Qty
<b>BDCER81001</b>	1 Pc

GLASS PANE DIMENSIONS

BDCER81001

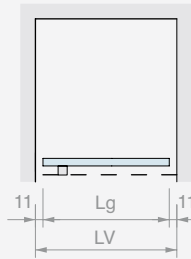
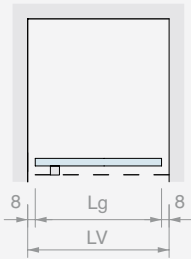
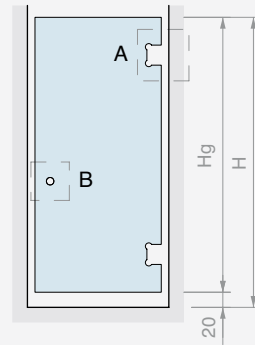
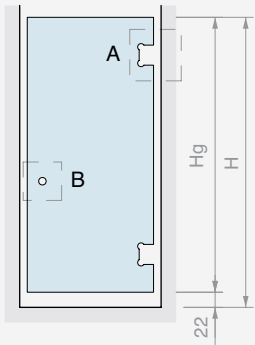

$H_g = H - 22$   
 $L_g (\text{MAX } 850) = LV - 16$

$H_g = H - 20$   
 $L_g (\text{MAX } 850) = LV - 23$

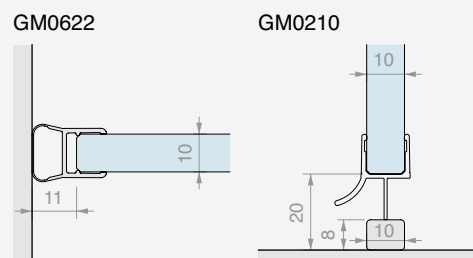
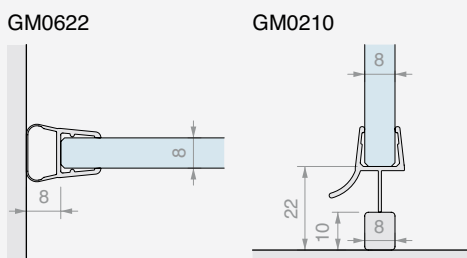
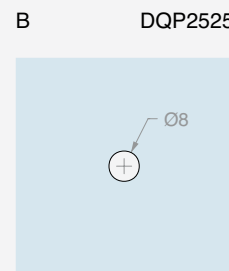
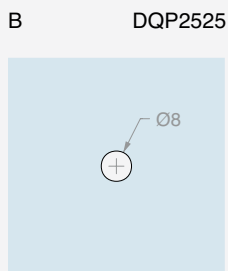
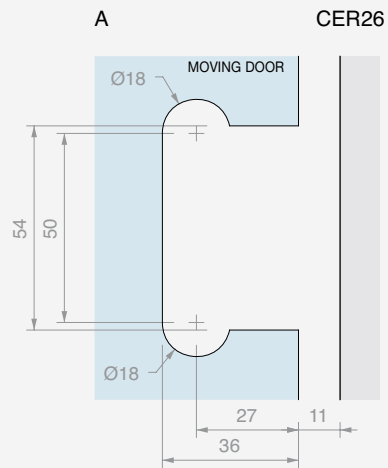
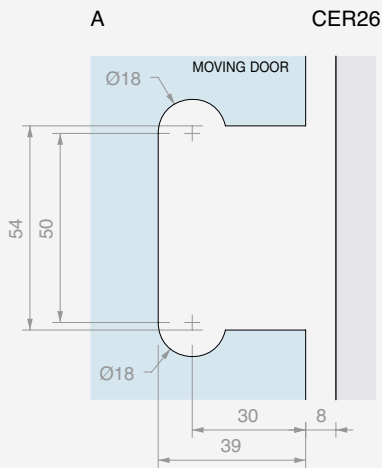



**WALL/WALL HINGED  
SHOWER KIT WITH FIXED PANE AND CLAMPS**

Finish: /1 /2 /3 /4

8/10	LgMAX 850	LMAX 1450	HMAX 2200	40
------	--------------	--------------	--------------	----

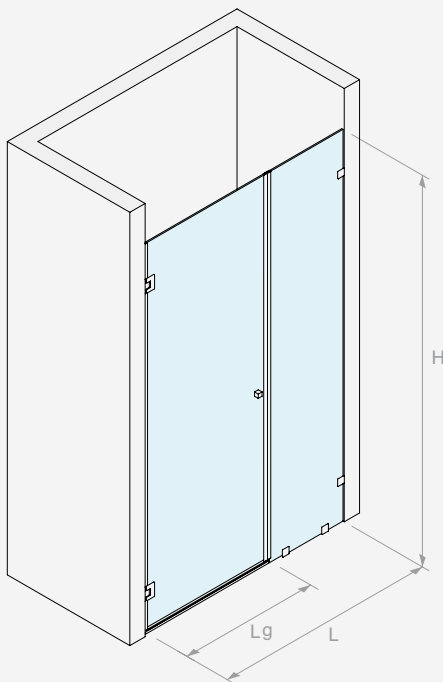

Kit comprising:

Art.	Description	Qty.
<b>CER26</b>	Side hinge	2 Pcs
<b>PESQ0810B.100</b>	Water barrier profile	1 Pc
<b>GM0210</b>	Gasket with drip flap	1 Pc
<b>GM1520SX</b>	Magnetic 45° gasket	1 Pc
<b>GM1520DX</b>	Magnetic 45° gasket	1 Pc
<b>GM0622</b>	Balloon gasket	1 Pc
<b>DQP2525</b>	Pair of knobs	1 Pc
<b>MORS001</b>	Clamp flush to the wall	4 Pcs
Optional		
<b>MF1515</b>	Jointed stabilizer bar	1 Pc

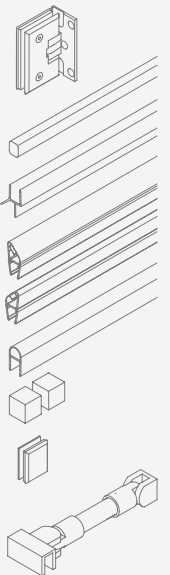

Art.	Qty
<b>BDCER81003</b>	1 Pc



GLASS PANE DIMENSIONS

BDCER81003

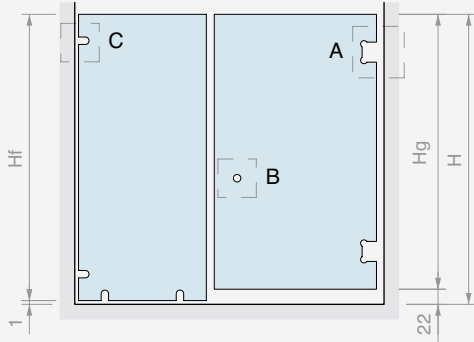

$H_f = H - 1$   
 $H_g = H - 22$   
 $L_g \text{ MAX } 850$   
 $L_f (\text{MAX } 800) =$   
 $LV - L_g - 26$

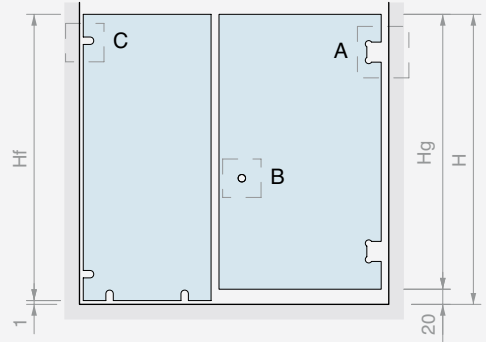
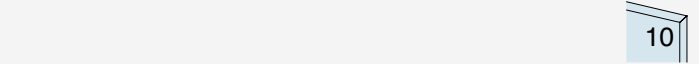
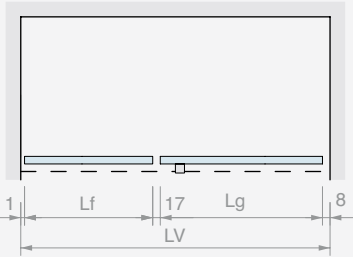

$H_f = H - 1$   
 $H_g = H - 20$   
 $L_g \text{ MAX } 850$   
 $L_f (\text{MAX } 800) =$   
 $LV - L_g - 35$

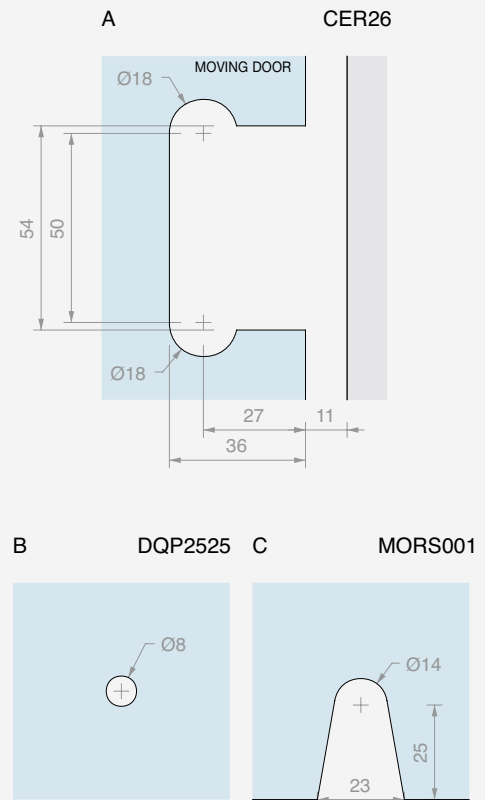
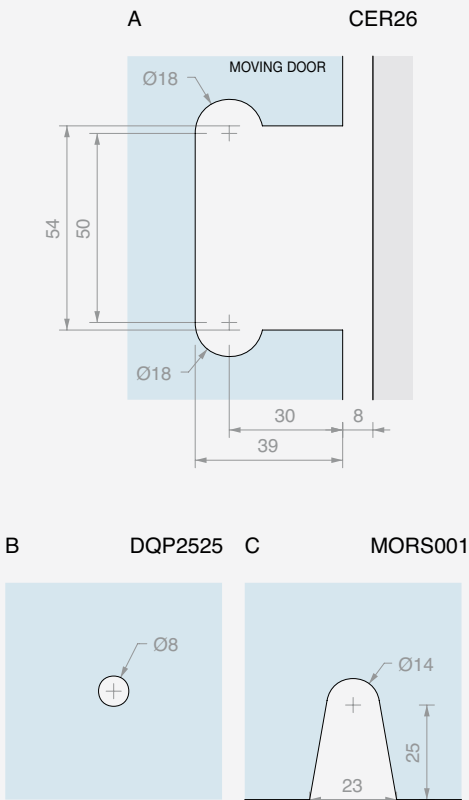
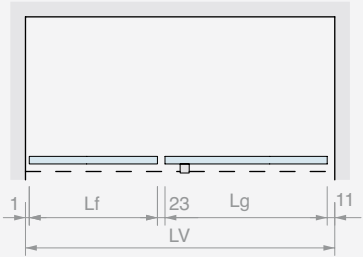

GM1520SX  
GM1520DX

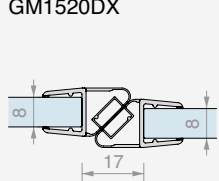

GM0210

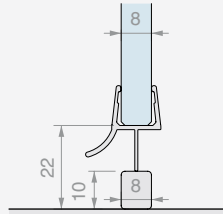

GM0622

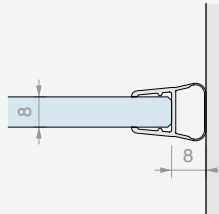

GM1520SX  
GM1520DX

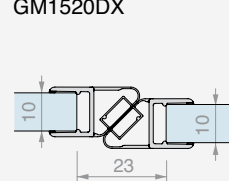

GM0210

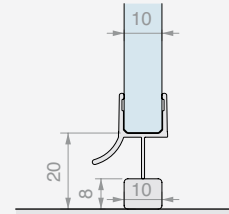

GM0622

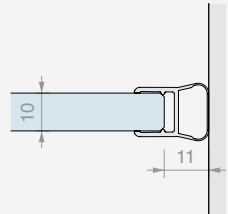



**WALL/WALL HINGED  
SHOWER KIT WITH FIXED PANE AND PROFILES**

Finish: /1 /2 /3 /4

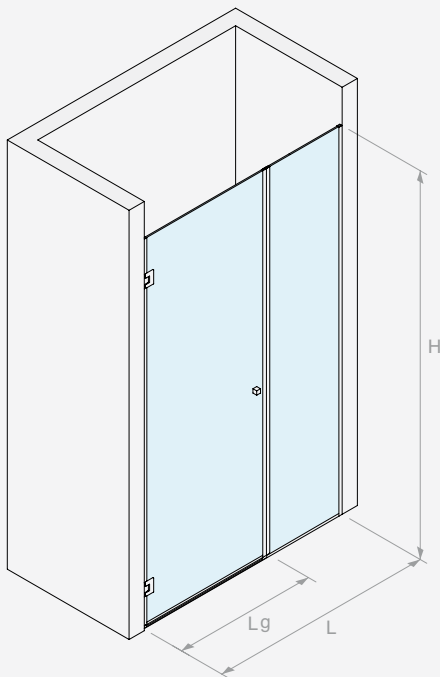
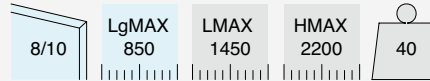

Kit comprising:

Art.	Description	Qty.
<b>CER26</b>	Side hinge	2 Pcs
<b>LMU20B.220</b>	U-shaped profile	1 Pc
<b>LMU20B.150</b>	U-shaped profile	1 Pc
<b>LMU86B.100</b>	Flat upper profile	1 Pc
<b>GTUP4</b>	Glass holder gasket	4 m
<b>GTUP2</b>	Glass holder gasket	4 m
<b>GM0210</b>	Gasket with drip flap	1 Pc
<b>GM1520SX</b>	Magnetic 45° gasket	1 Pc
<b>GM1520DX</b>	Magnetic 45° gasket	1 Pc
<b>GM0622</b>	Balloon gasket	1 Pc
<b>DQP2525</b>	Pair of knobs	1 Pc
Optional		
<b>MF1515</b>	Jointed stabilizer bar	1 Pc

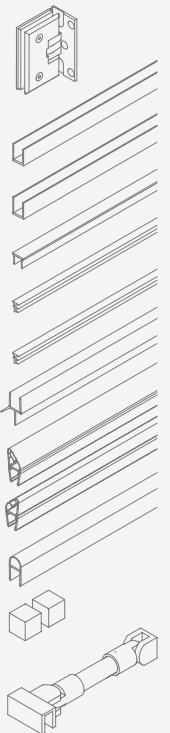

Art.	Qty
<b>BDCER81005</b>	1 Pc

GLASS PANE DIMENSIONS

BDCER81005

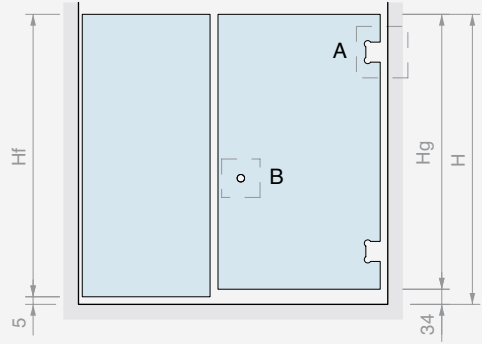
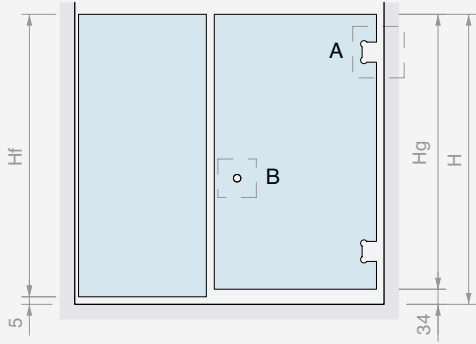

Hf = H - 5  
 Hg = H - 34  
 Lg MAX 850  
 Lf (MAX 600) = 5 + Lf + 17 + Lg + 8  
 LV = Lg - 30

Hf = H - 5  
 Hg = H - 34  
 Lg MAX 850  
 Lf (MAX 600) = 5 + Lf + 23 + Lg + 11  
 LV = Lg - 39

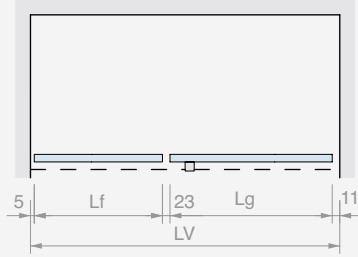
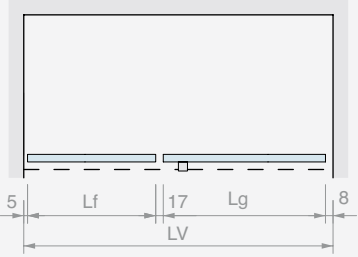

A CER26

A CER26

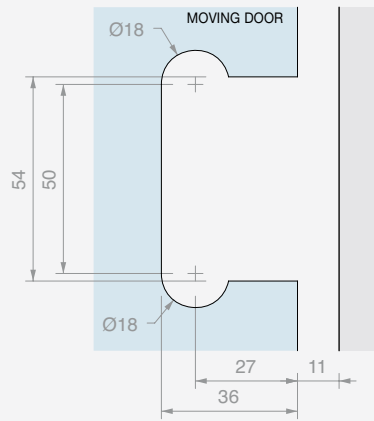
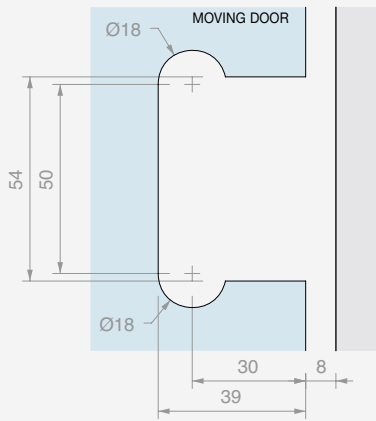

B DQP2525

B DQP2525

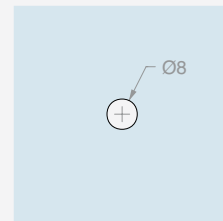
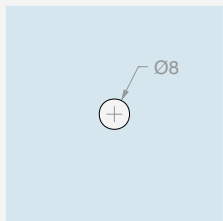

GM1520SX  
 GM1520DX

GM0210

GM0622

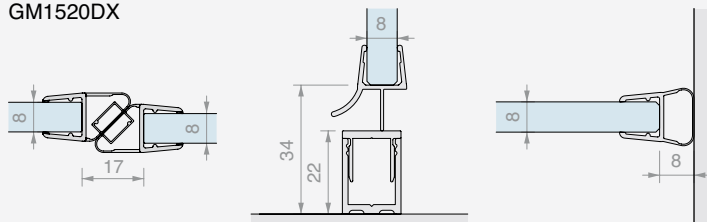

GM1520SX  
 GM1520DX

GM0210

GM0622

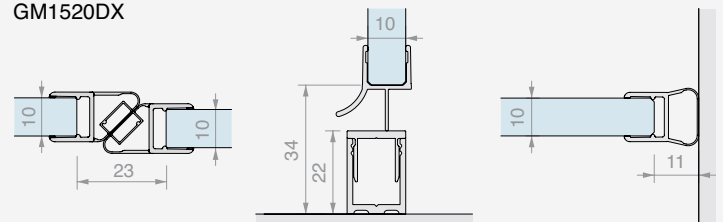



**WALL/GLASS HINGED SHOWER  
KIT WITH FIXED PANE AND CLAMPS**

Finish: /1 /2 /3 /4

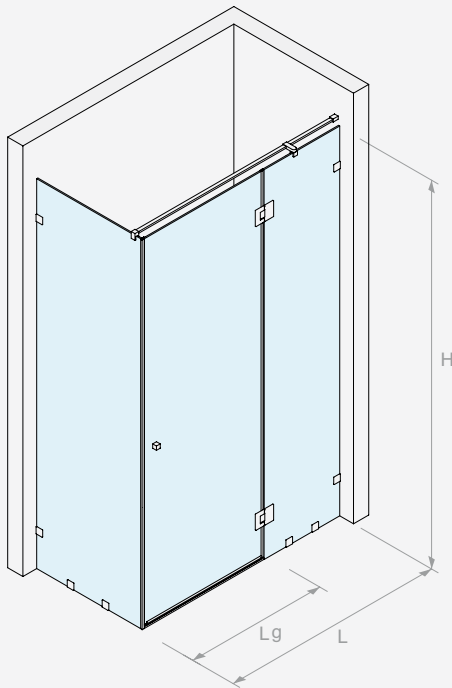
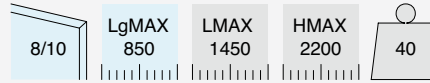

Kit comprising:

Art.	Description	Qty.
<b>CER29</b>	Side hinge	2 Pcs
<b>PESQ0810B.100</b>	Water barrier profile	1 Pc
<b>GM0210</b>	Gasket with drip flap	1 Pc
<b>GM5422</b>	90° strike jamb gasket	1 Pc
<b>GM0422</b>	Gasket with lip	1 Pc
<b>DQP2525</b>	Pair of knobs	1 Pc
<b>DQT1500</b>	Fixed stabilizer bar	1 Pc
<b>DQA90</b>	Distanced glass fixing	1 Pc
<b>MORS001</b>	Clamp flush to the wall	8 Pcs

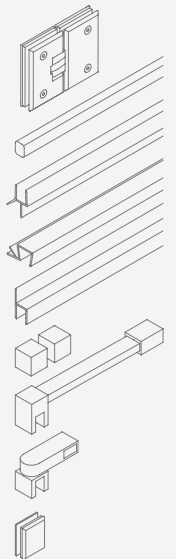

Art.	Qty.
<b>BDCER81007</b>	1 Pc

GLASS PANE DIMENSIONS

BDCER81007

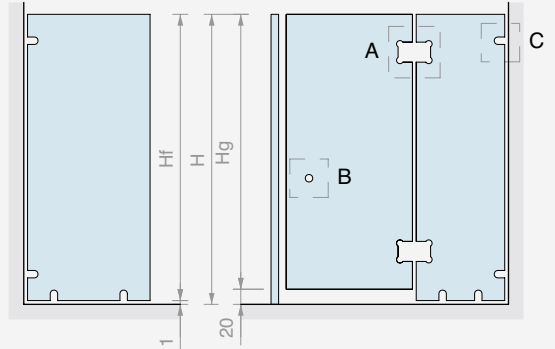
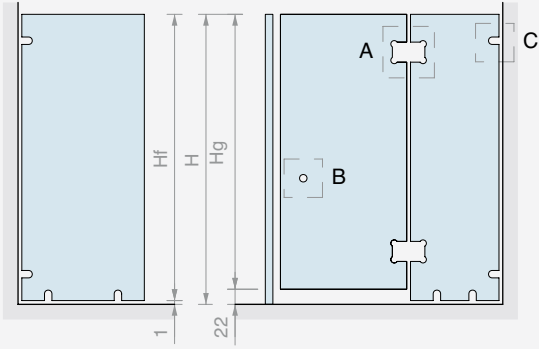

Hf = H - 1  
 Hg = H - 22  
 Lg MAX 850  
 Lf (MAX 800) = PV - 6  
 Lf1 (MAX 600) = LV - Lg - 23

Hf = H - 1  
 Hg = H - 20  
 Lg MAX 850  
 Lf (MAX 800) = PV - 6  
 Lf1 (MAX 600) = LV - Lg - 25

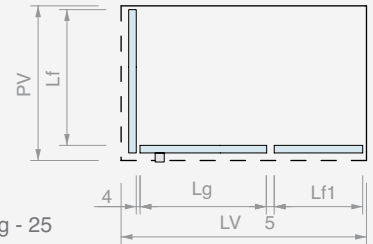
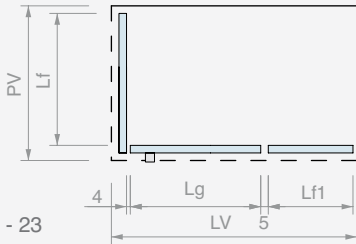

A CER29

A CER29

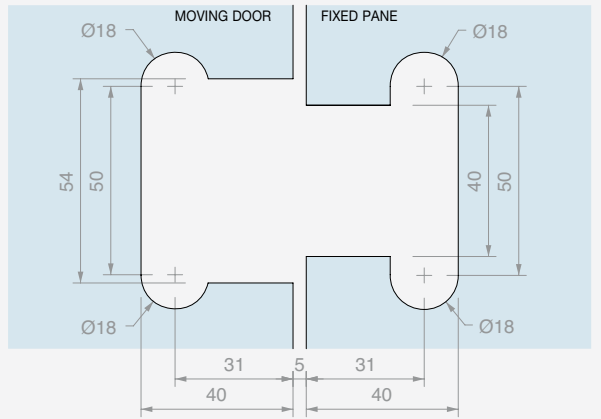
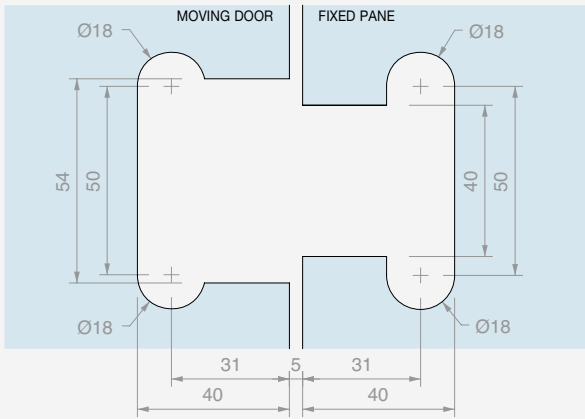

B DQP2525 C MORS001

B DQP2525 C MORS001

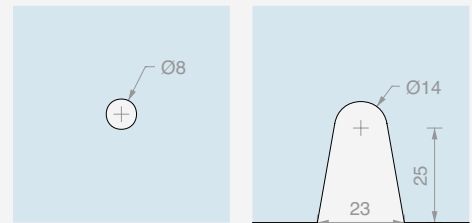
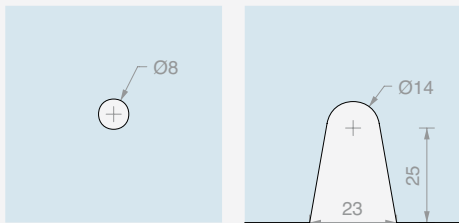

GM5422 GM0210 GM0422

GM5422 GM0210 GM0422

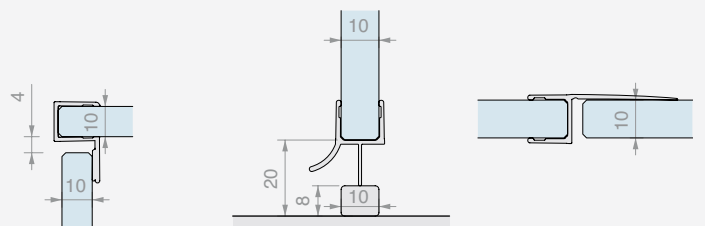
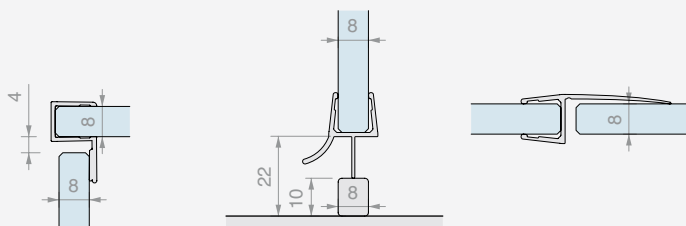



**WALL/WALL CORNER HINGED  
SHOWER KIT WITH FIXED PANE AND CLAMPS**

Finish: /1 /2 /3 /4

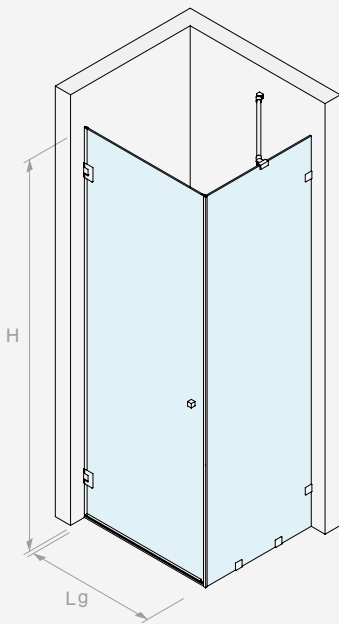
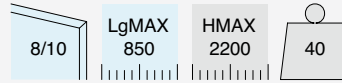

Kit comprising:

Art.	Description	Qty.
<b>CER26</b>	Side hinge	2 Pcs
<b>PESQ0810B.100</b>	Water barrier profile	1 Pc
<b>GM0210</b>	Gasket with drip flap	1 Pc
<b>GM5422</b>	90° strike jamb gasket	1 Pc
<b>GM0622</b>	Balloon gasket	1 Pc
<b>DQP2525</b>	Pair of knobs	1 Pc
<b>MF1515</b>	Jointed stabilizer bar	1 Pc
<b>MORS001</b>	Clamp flush to the wall	4 Pcs

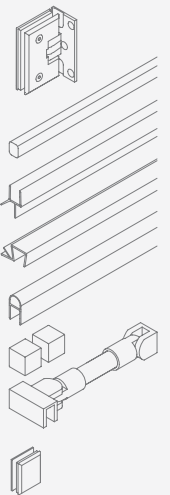

Art.	Qty
<b>BDCER81013</b>	1 Pc

GLASS PANE DIMENSIONS

BDCER81013

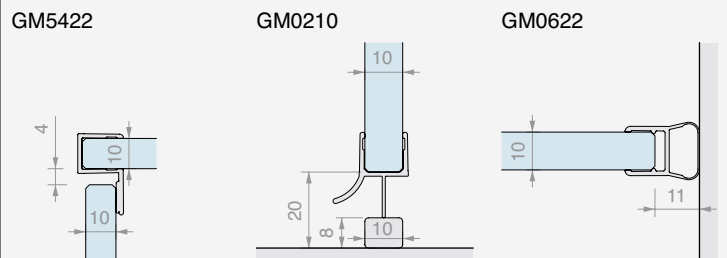
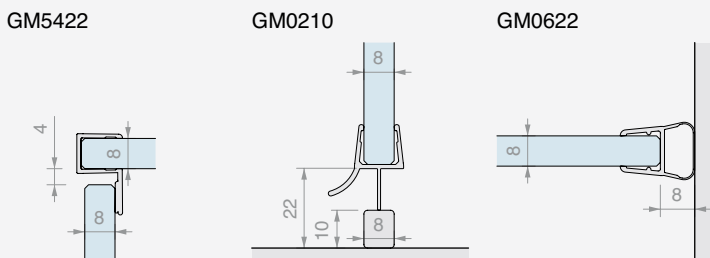
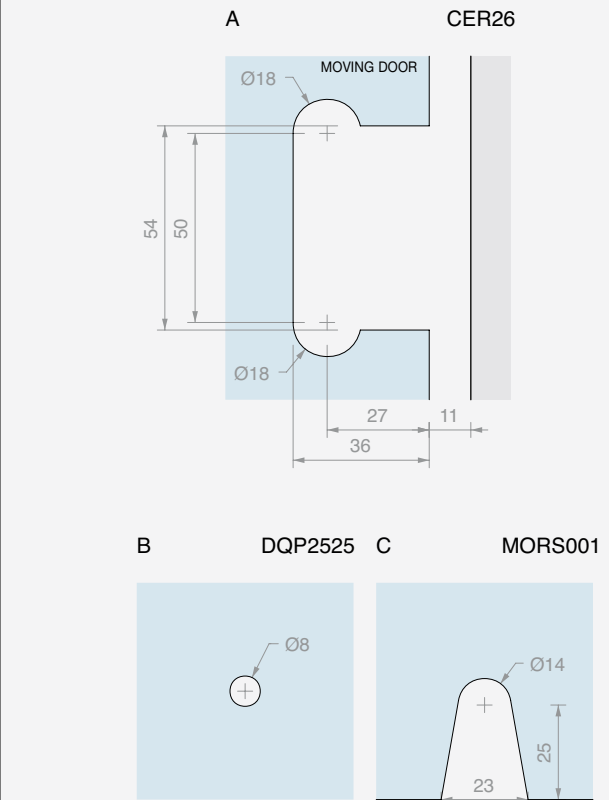
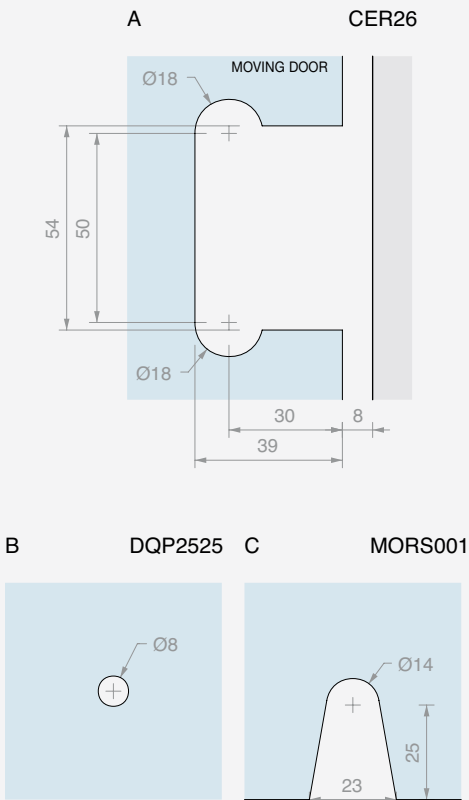
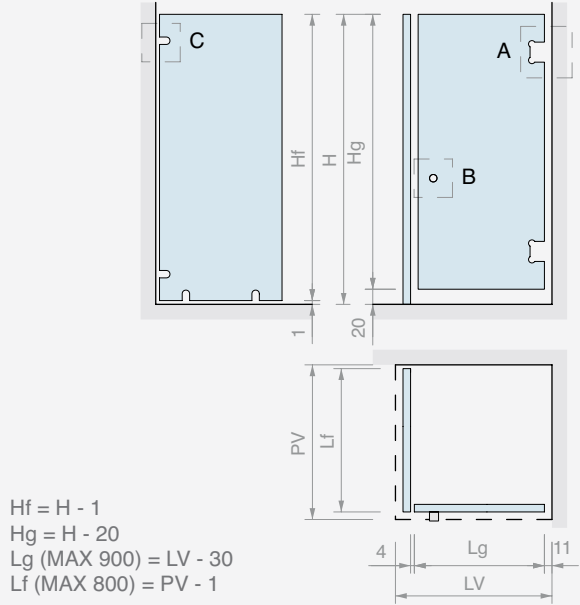
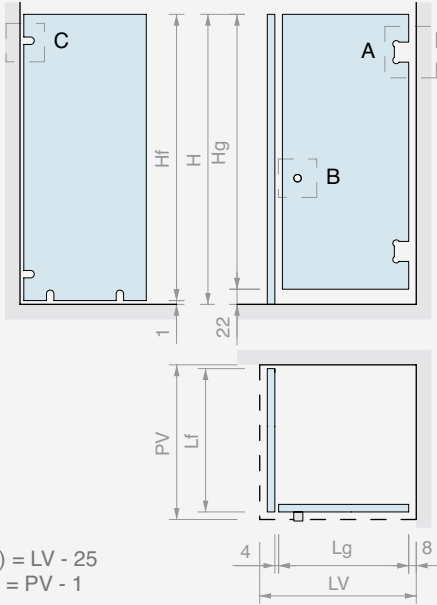



**WALL/WALL CORNER HINGED  
SHOWER KIT WITH FIXED PANE AND PROFILES**

Finish: /1 /2 /3 /4

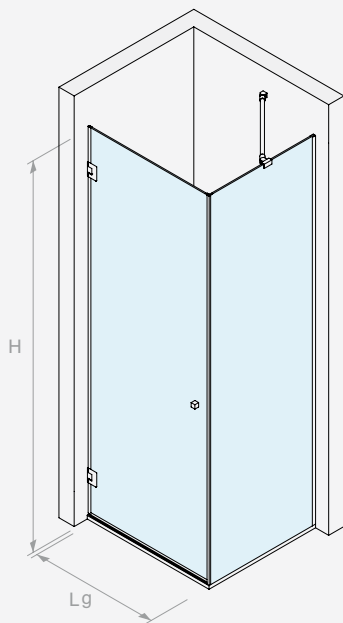
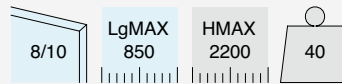

Kit comprising:

Art.	Description	Qty.
<b>CER26</b>	Side hinge	2 Pcs
<b>LMU20B.220</b>	U-shaped profile	2 Pcs
<b>LMU86B.100</b>	Flat upper profile	1 Pc
<b>GTUP4</b>	Glass holder gasket	4 m
<b>GTUP2</b>	Glass holder gasket	4 m
<b>GM5422</b>	90° strike jamb gasket	1 Pc
<b>GM0210</b>	Gasket with drip flap	1 Pc
<b>GM0622</b>	Balloon gasket	1 Pc
<b>DQP2525</b>	Pair of knobs	1 Pc
<b>MF1515</b>	Jointed stabilizer bar	1 Pc

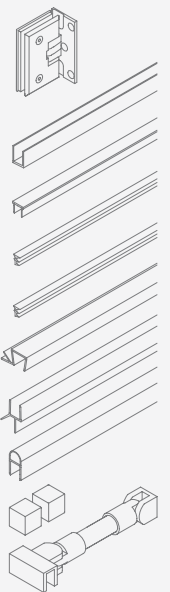

Art.	Qty
<b>BDCER81015</b>	1 Pc



GLASS PANE DIMENSIONS

BDCER81015

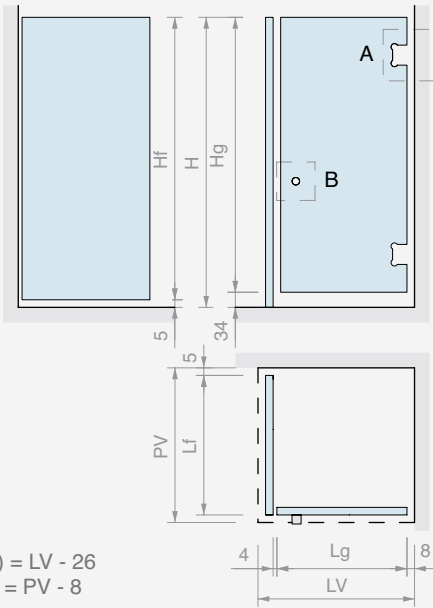

Hf = H - 5  
 Hg = H - 34  
 Lg (MAX 900) = LV - 26  
 Lf (MAX 800) = PV - 8

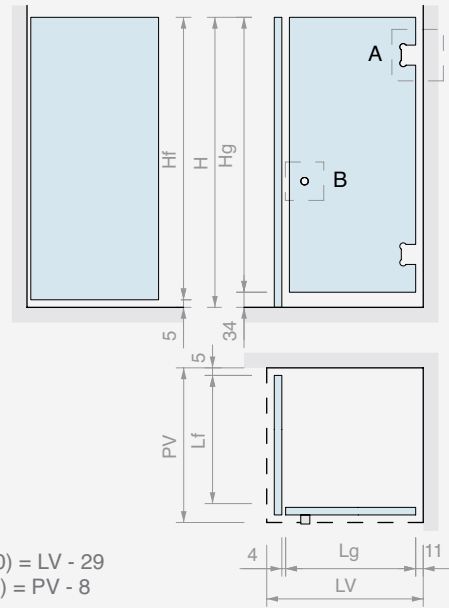

Hf = H - 5  
 Hg = H - 34  
 Lg (MAX 900) = LV - 29  
 Lf (MAX 800) = PV - 8

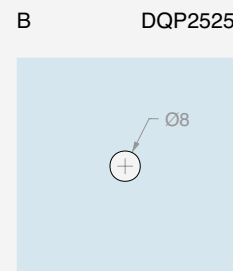
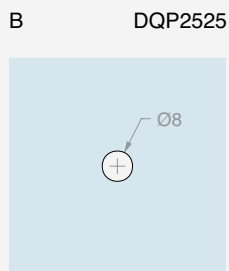
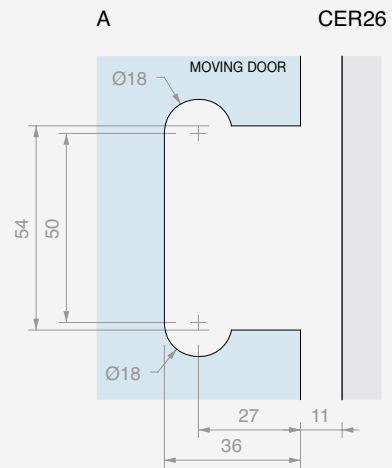
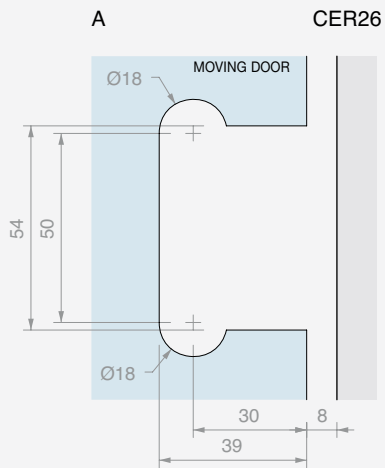

GM5422

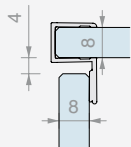

GM0210

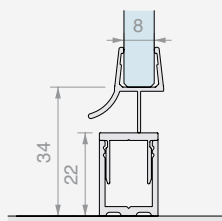

GM0622

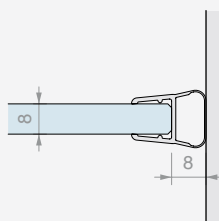

GM5422

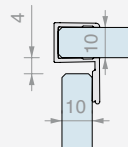

GM0210

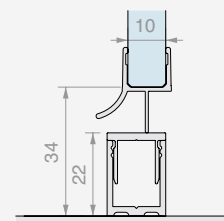

GM0622

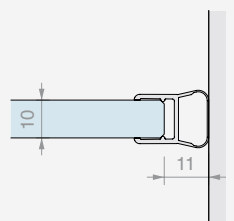



**TWO-SIDE WALK-IN  
SHOWER KIT WITH CLAMPS**

Finish: /1 /2 /3 /4

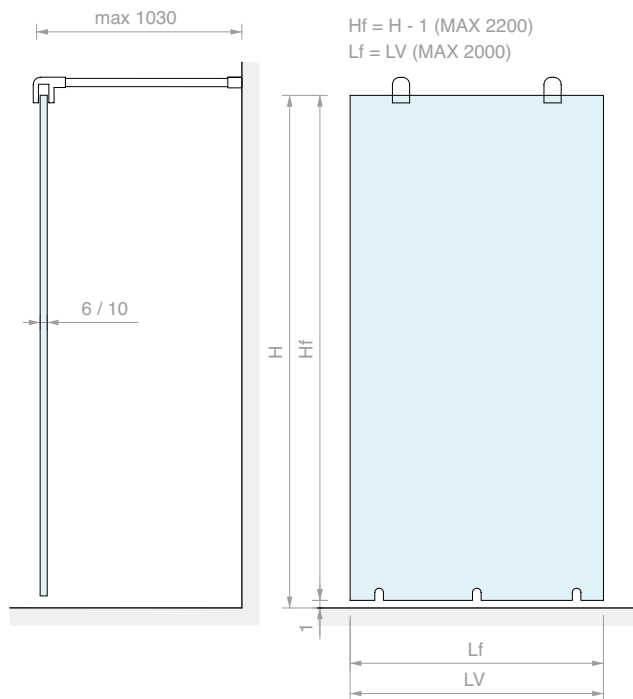
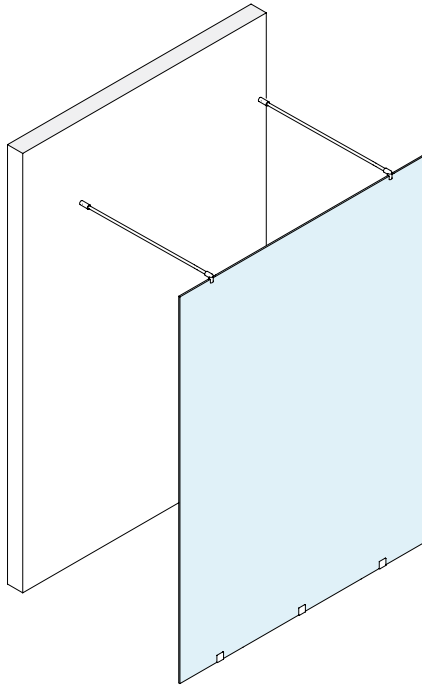

MORS001

MF127

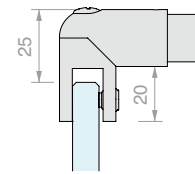
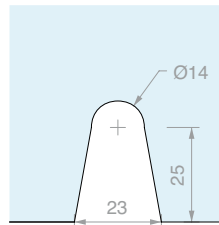

Kit comprising:

Art.	Description	Qty.
<b>MORS001</b>	Clamp flush to the wall	3 Pcs
<b>MF127</b>	Fixed stabilizer bar	2 Pcs

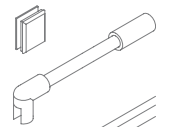

Optional

<b>PESQ0810B.150</b>	Water barrier profile	2 Pcs
----------------------	-----------------------	-------

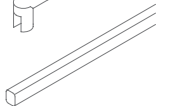

Art.	For glass	Qty
<b>OPEN03MORS</b>	From 6 to 10 mm	1 Pc



**TWO-SIDE WALK-IN  
SHOWER KIT WITH PROFILES**

Finish:    

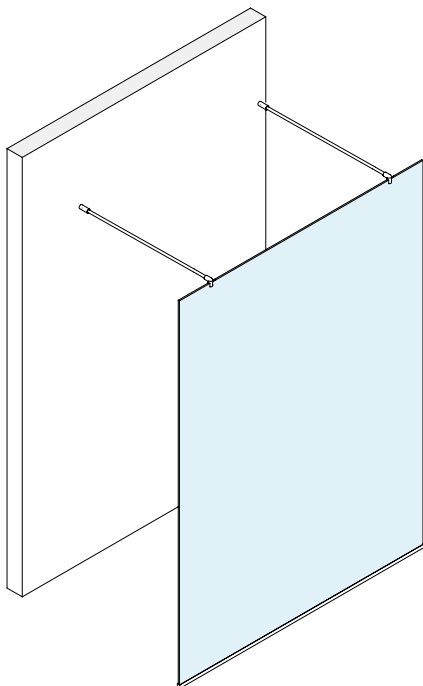

LMU20B.220

MF127

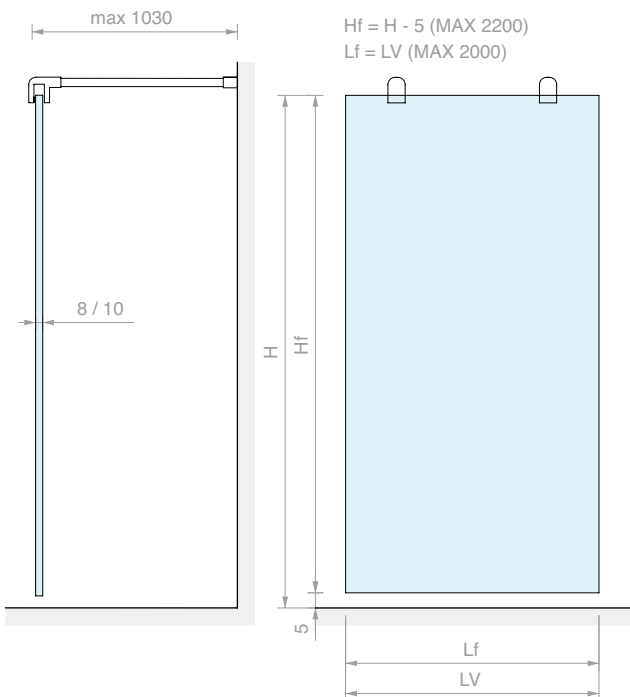
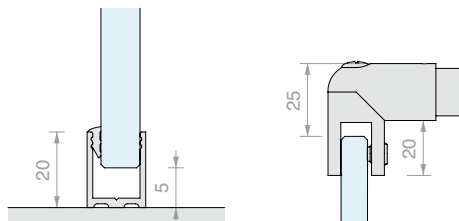

Kit comprising:

Art.	Description	Qty.
<b>LMU20B.220</b>	U-shaped profile	1 Pc
<b>LMU20TPB</b>	Flat cap	2 Pcs
<b>GTUP2</b>	Glass holder gasket	2 m
<b>GTUP4</b>	Glass holder gasket	2 m
<b>MF127</b>	Fixed stabilizer bar	2 Pcs
Optional		
<b>PESQ0810B.150</b>	Water barrier profile	2 Pcs

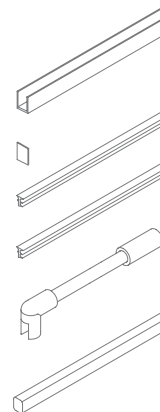

Art.	For glass	Qty
<b>OPEN03LMUMF</b>	From 8 to 10 mm	1 Pc



**WALK-IN SHOWER KIT WITH CLAMPS**

Finish: /1 /2 /3 /4

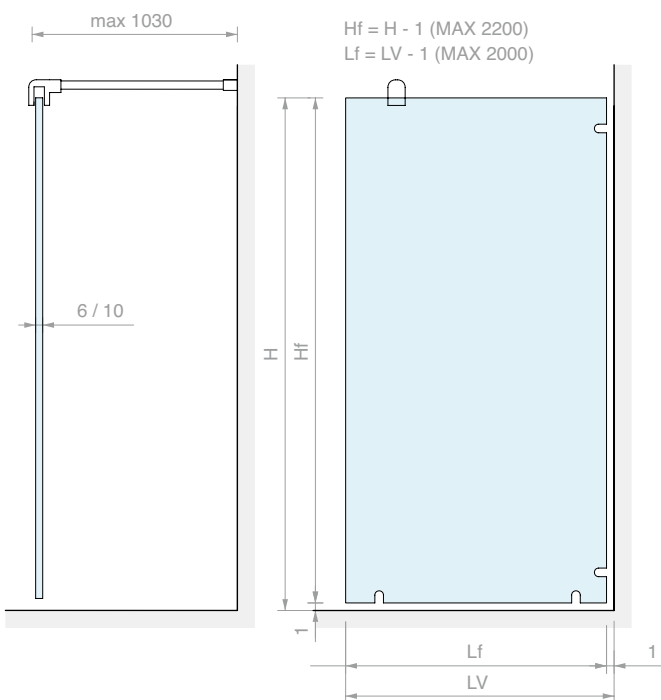
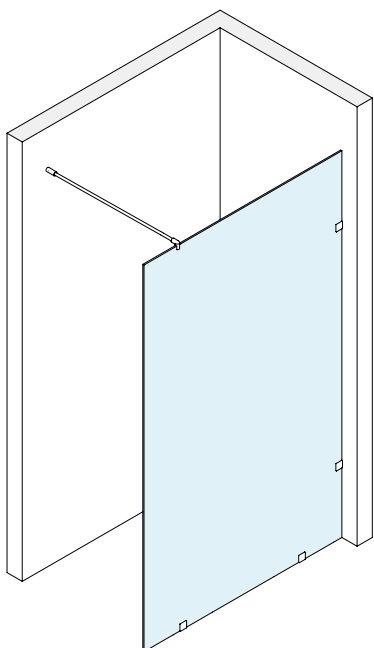

MORS001

MF127

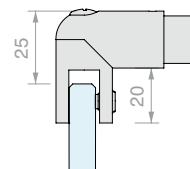
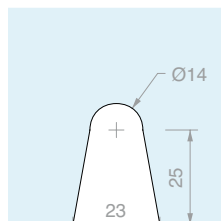

Kit comprising:

Art.	Description	Qty.
<b>MORS001</b>	Clamp flush to the wall	4 Pcs
<b>MF127</b>	Fixed stabilizer bar	1 Pc
Optional		
<b>PESQ0810B.150</b>	Water barrier profile	1 Pc

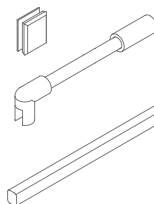

Art.	For glass	Qty
<b>OPEN01MORS</b>	From 6 to 10 mm	1 Pc





**WALK-IN SHOWER KIT WITH PROFILES**

Finish:    

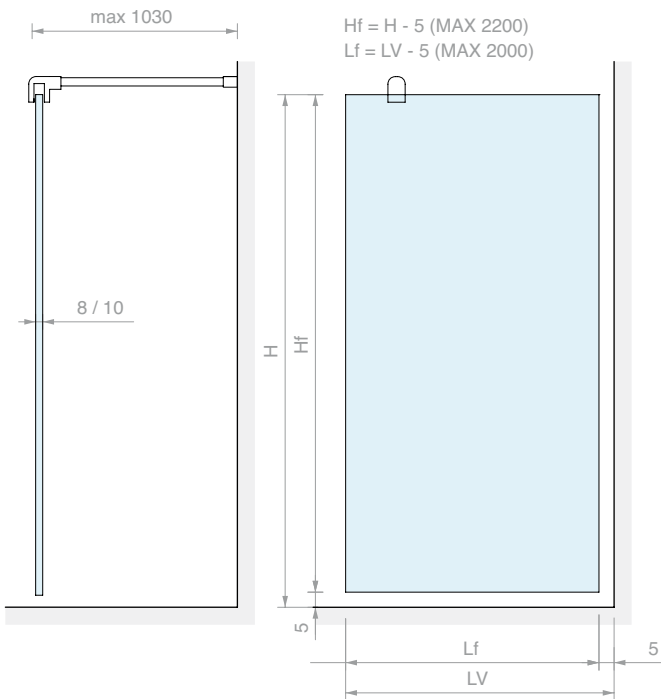
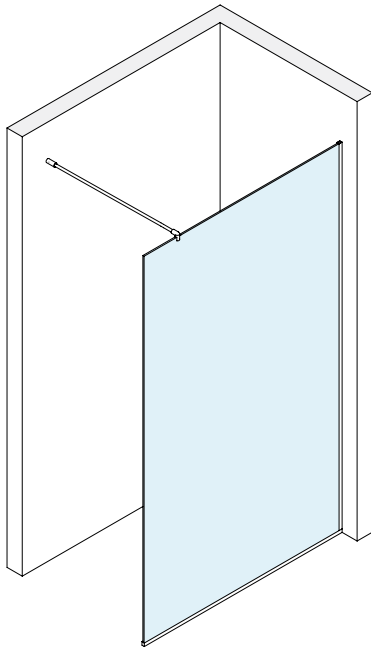

LMU20B.220

MF127

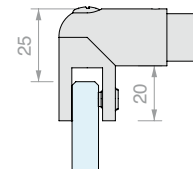
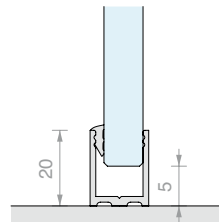

Kit comprising:

Art.	Description	Qty.
<b>LMU20B.220</b>	U-shaped profile	2 Pcs
<b>LMU20TPB</b>	Flat cap	1 Pc
<b>GTUP2</b>	Glass holder gasket	5 m
<b>GTUP4</b>	Glass holder gasket	5 m
<b>MF127</b>	Fixed stabilizer bar	1 Pc
Optional		
<b>PESQ0810B.150</b>	Water barrier profile	1 Pc

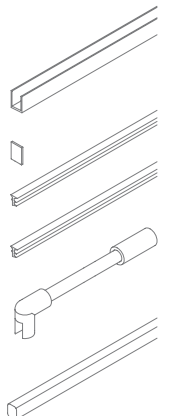

Art.	For glass	Qty
<b>OPEN01LMUMF</b>	From 8 to 10 mm	1 Pc



# TABLE OF CER SERIES ACCESSORIES

**Hinges** for glass thickness from 6 to 10 mm

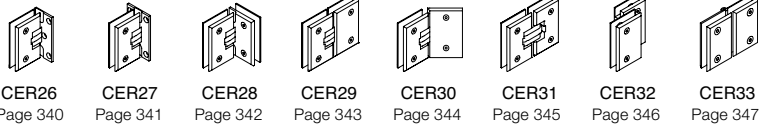

CER26 Page 340 CER27 Page 341 CER28 Page 342 CER29 Page 343 CER30 Page 344 CER31 Page 345 CER32 Page 346 CER33 Page 347

**Clamps** for glass thickness from 6 to 10 mm

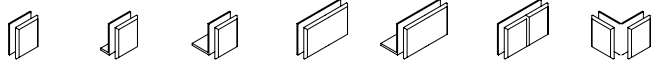

MORS001 Page 348 MORS002 Page 348 MORS0023 Page 348 MORS003 Page 348 MORS0033 Page 349 MORS004 Page 349 MORS005 Page 349

**Stabilizer bars** for glass thickness from 6 to 10 mm

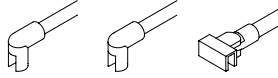

MF127 Page 350 MF129 Page 350 MF1515 Page 351

**Knobs** for glass thickness from 6 to 12 mm



DQTS2525 Page 352 DQP2525 Page 352 POM2525 Page 352

**Profiles for fixed panes and caps**



LMU20B Page 353 LMU86B Page 353 LMU20TPB Page 353 PESQB Page 353 PBD3183 Page 354 PBD3184 Page 354 PBD3186 Page 354 PBDTP Page 354

**Gaskets** for glass thickness from 8 to 10 mm

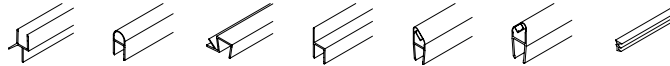

GM0210 Page 355 GM0622 Page 354 GM54 Page 355 GM0422 Page 355 GM1520SX Page 355 GM1520DX Page 355 GTUP Page 355



**WALL/GLASS SIDE HINGE**

Material: Brass

Finish: /1 /2 /3 /4

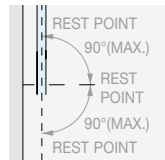
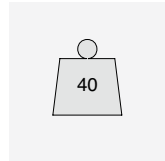
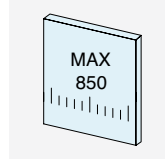
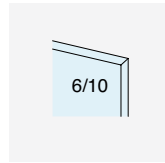

±90° ROTATION

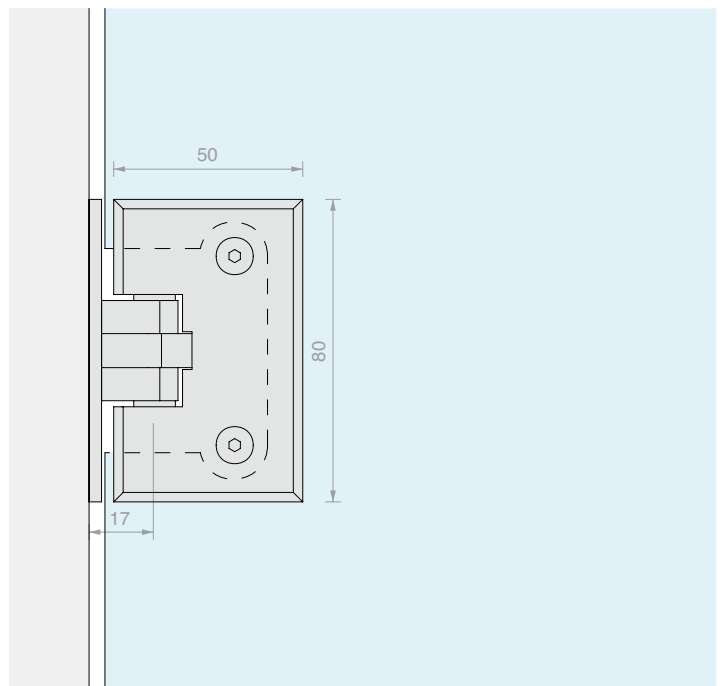
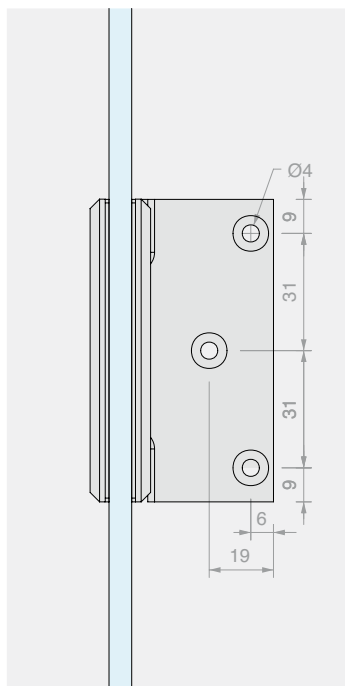
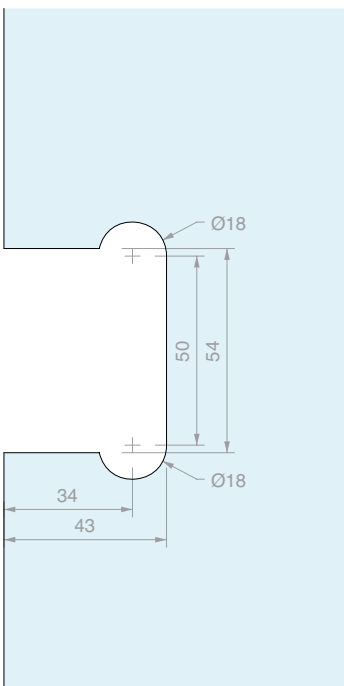
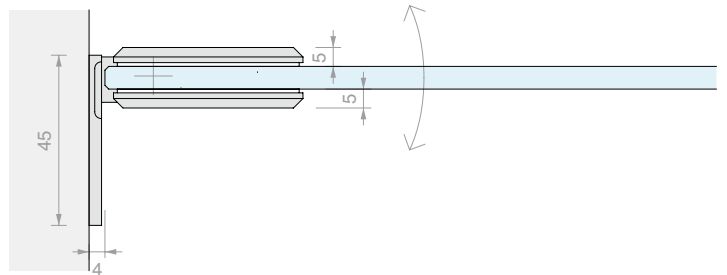

Art.  
**CER26**

For glass  
From 6 to 10 mm

Qty  
1 Pc

**WALL/GLASS CENTRAL HINGE**

Material: Brass

Finish: /1 /2 /3 /4

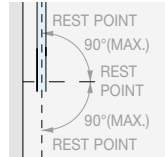
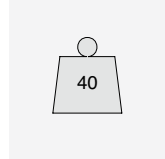
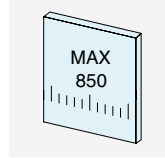
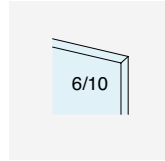

±90° ROTATION

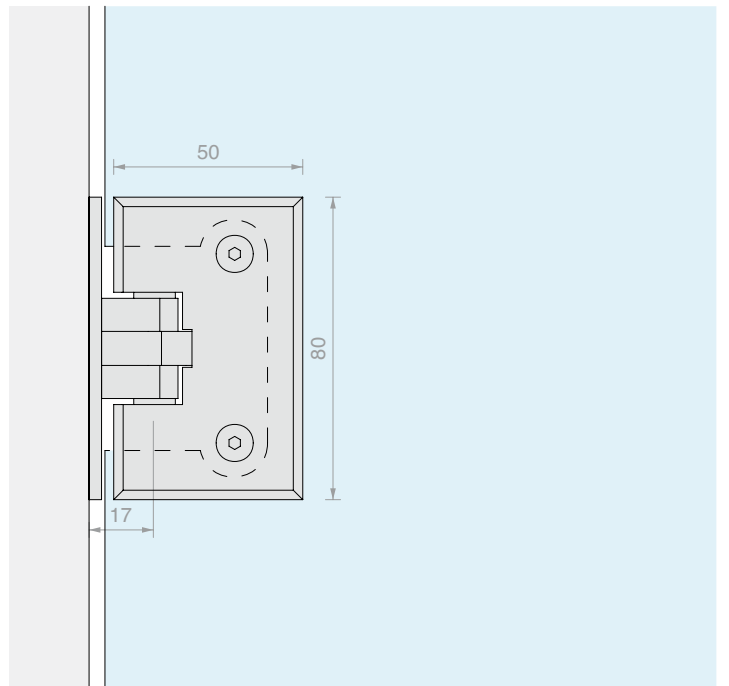
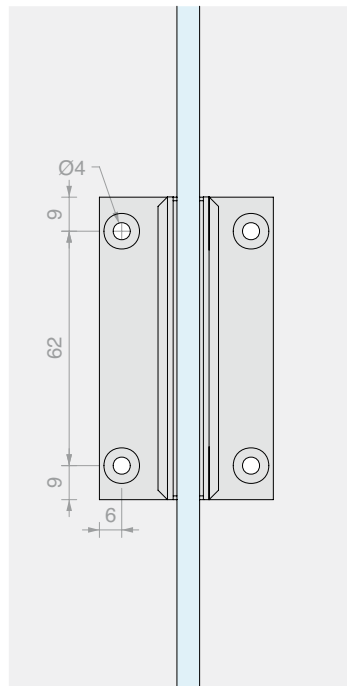
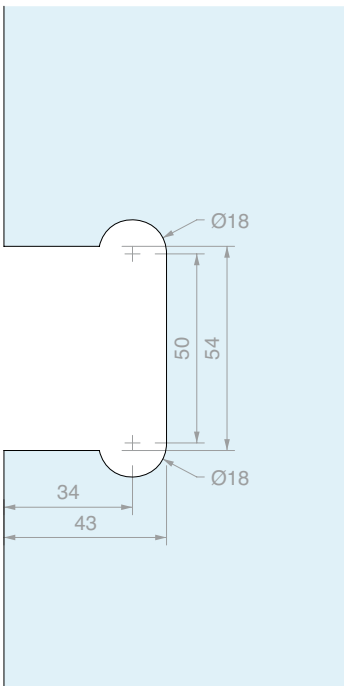
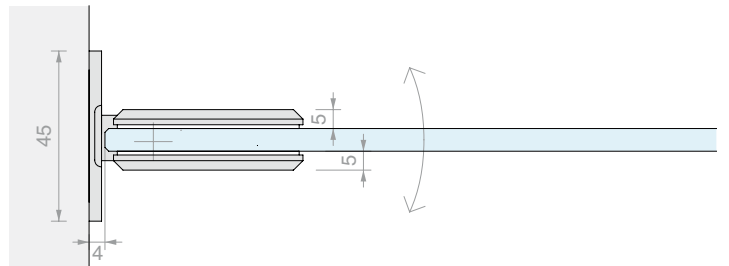

Art.  
**CER27**

For glass  
From **6** to **10** mm

Qty  
1 Pc



**90° GLASS/GLASS HINGE**

Material: Brass

Finish: /1 /2 /3 /4

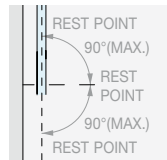
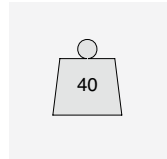
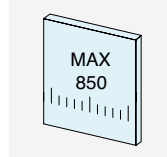
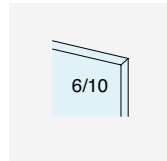

±90° ROTATION

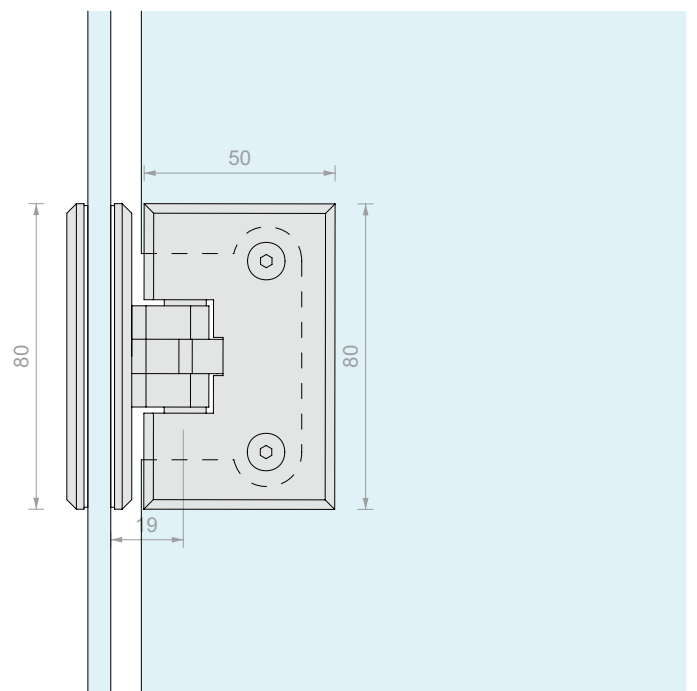
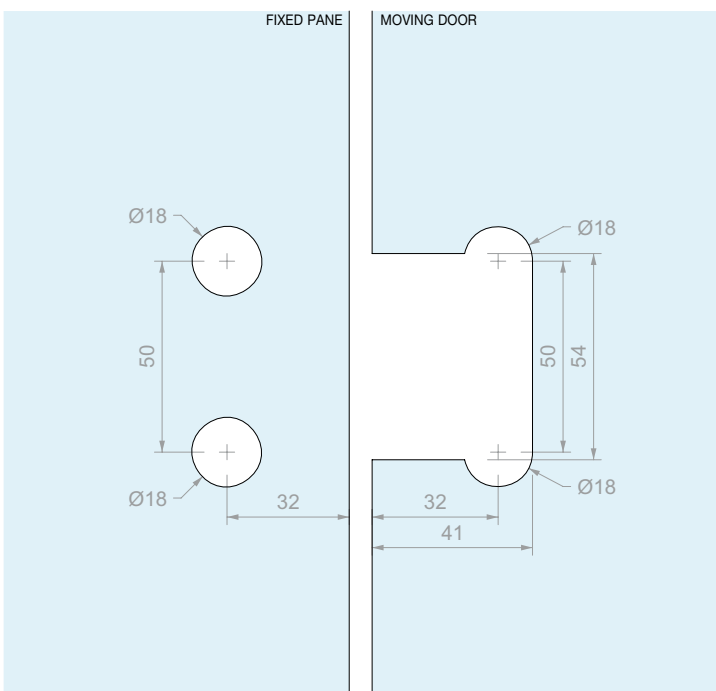
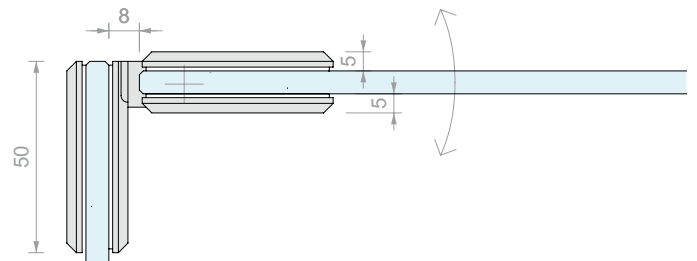

Art. **CER28** For glass From 6 to 10 mm

Qty 1 Pc



**GLASS/GLASS IN-LINE HINGE**

Material: Brass

Finish: /1 /2 /3 /4

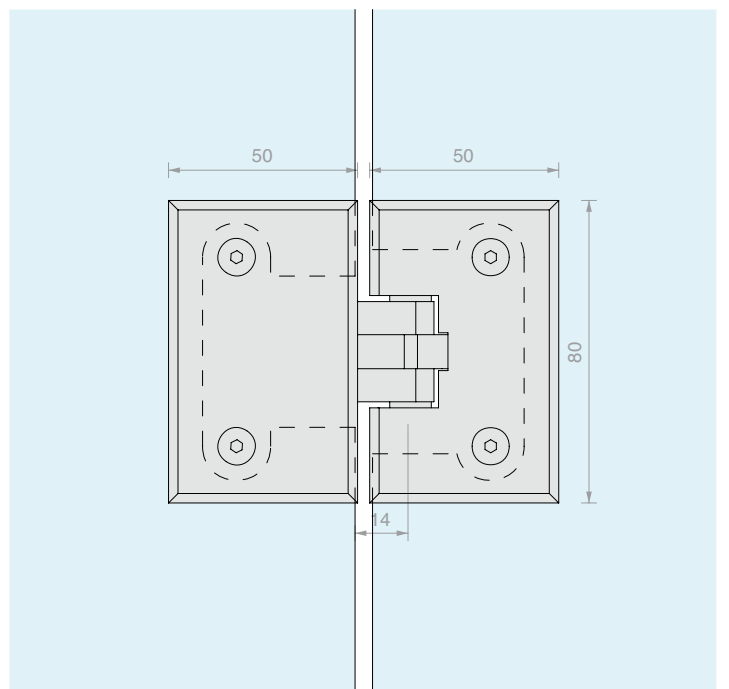
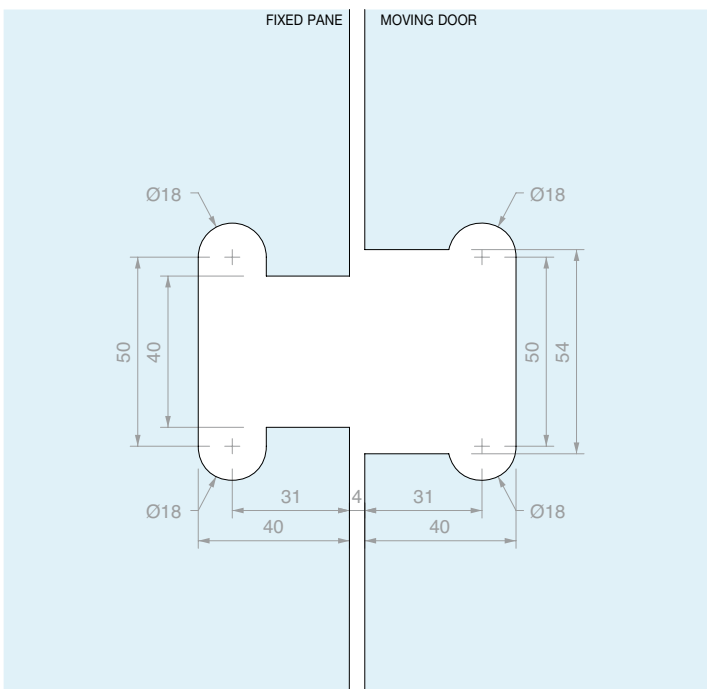
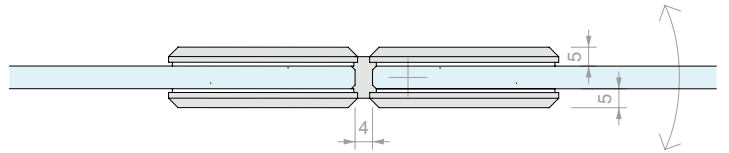
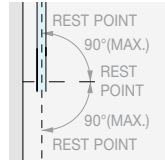
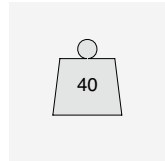
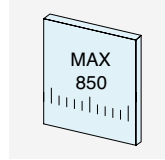
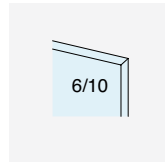

Art. **CER29** For glass From 6 to 10 mm

Qty 1 Pc



**135° GLASS/GLASS HINGE**

Material: Brass

Finish: /1 /2 /3 /4

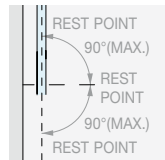
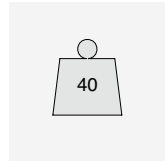
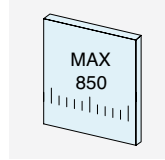
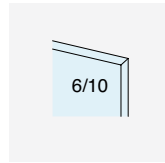

±90° ROTATION

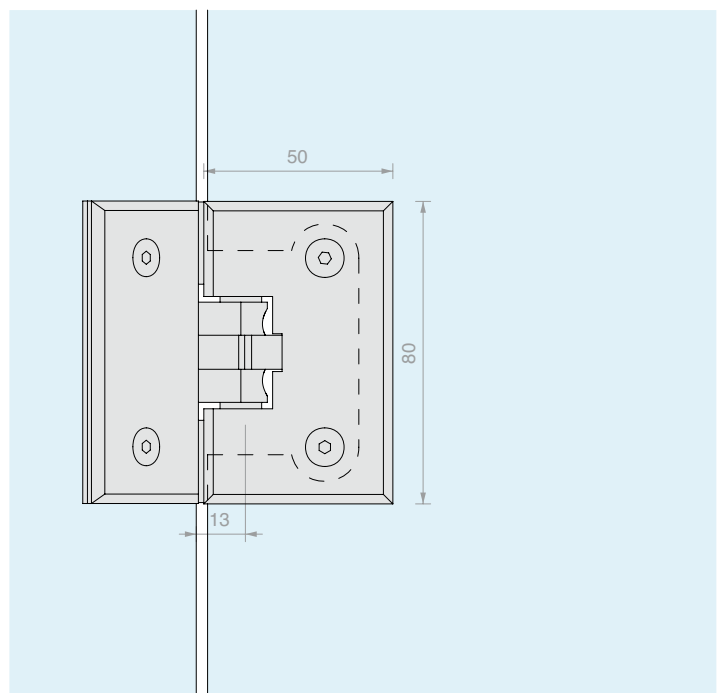
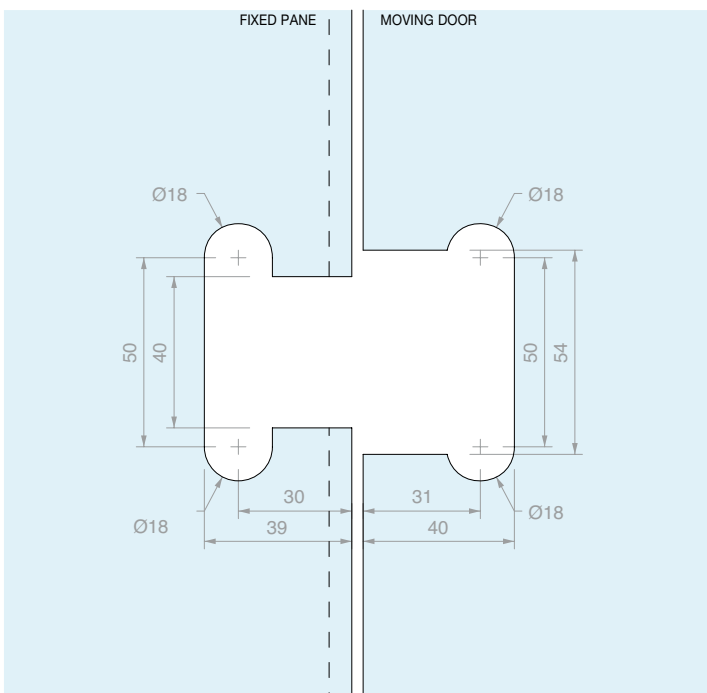
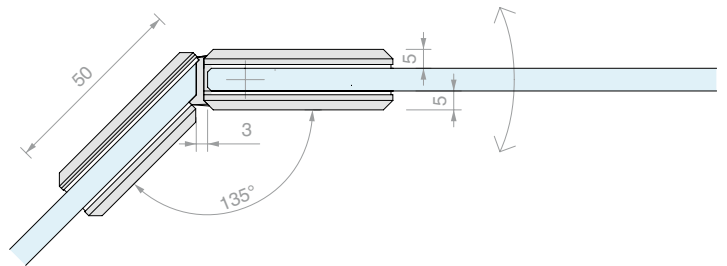
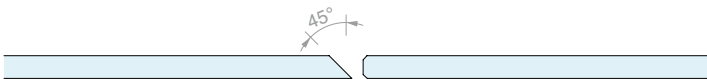

Art. **CER30** For glass From 6 to 10 mm

Qty 1 Pc





**GLASS/GLASS SAFETY HINGE**

Material: Brass

Finish: /1 /2 /3 /4

Note: The hinge does not work for packing

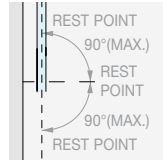
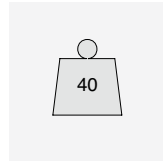
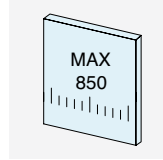
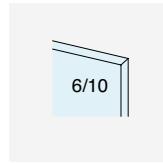

±90° ROTATION  
FURTHER SAFETY ROTATION ±90°

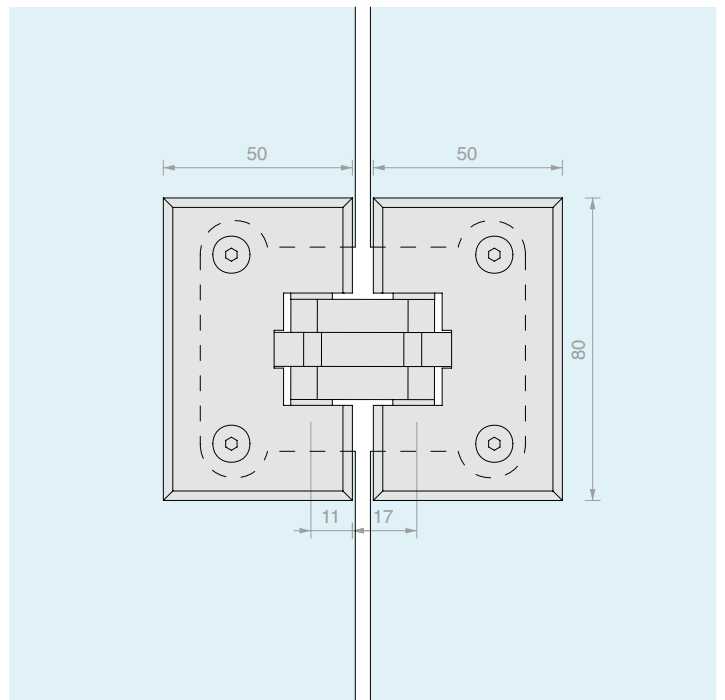
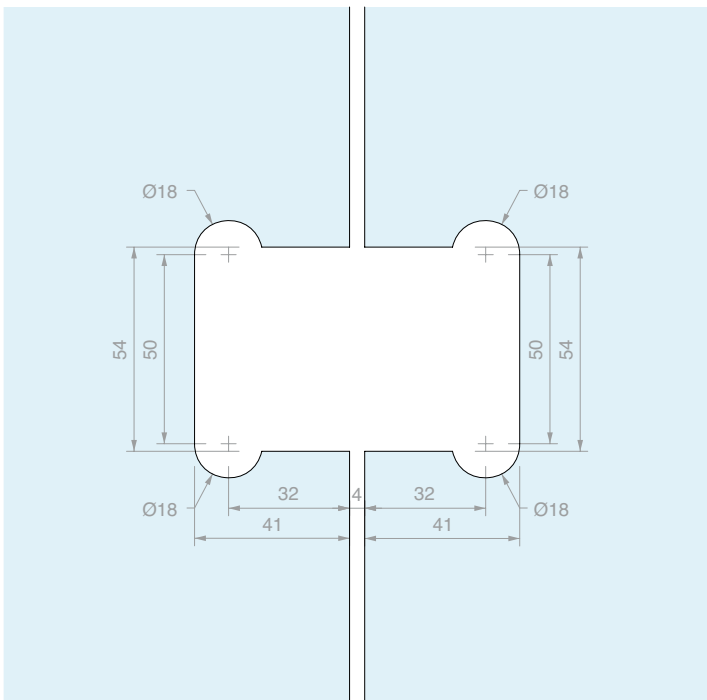
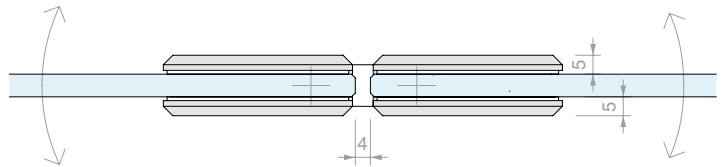

Art. **CER31** For glass From 6 to 10 mm

Qty 1 Pc



**GLASS/GLASS OVERLAP HINGE**

Material: Brass

Finish: /1 /2 /3 /4

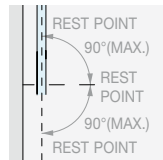
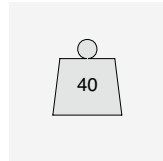
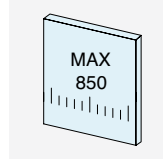
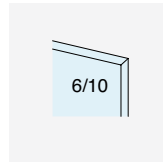

±90° ROTATION

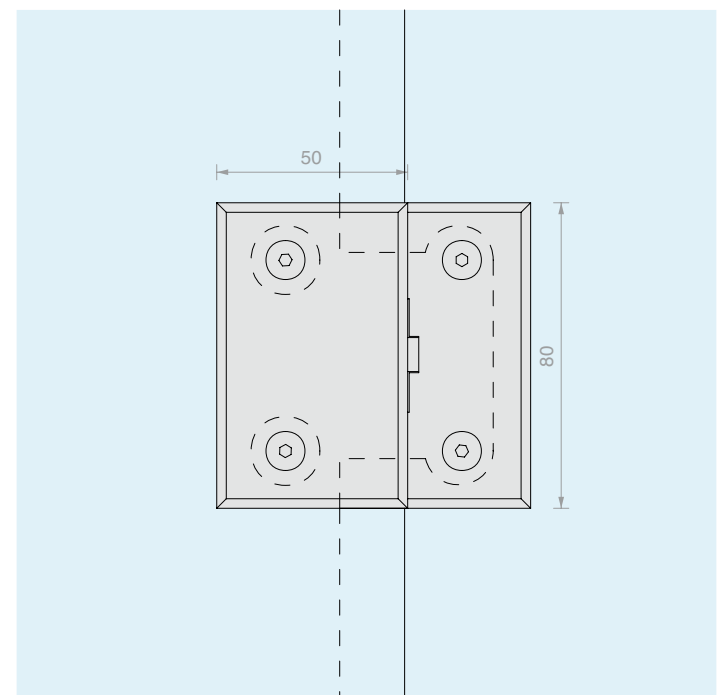
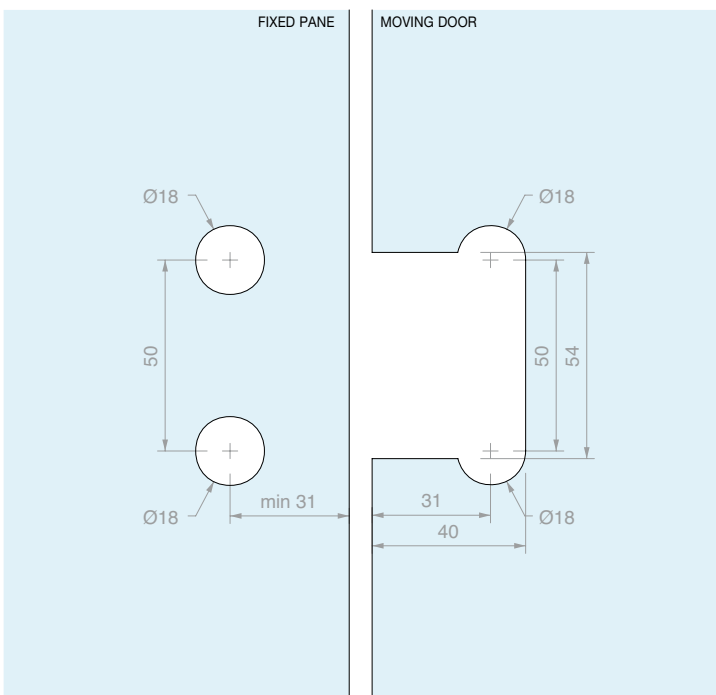
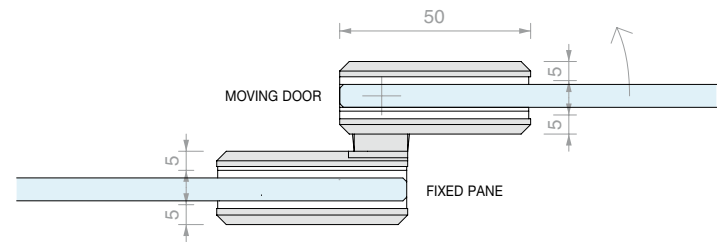

Art. **CER32** For glass From 6 to 10 mm

Qty 1 Pc



**GLASS/GLASS IN-LINE FOLDING HINGE**

Material: Brass

Finish: /1 /2 /3 /4

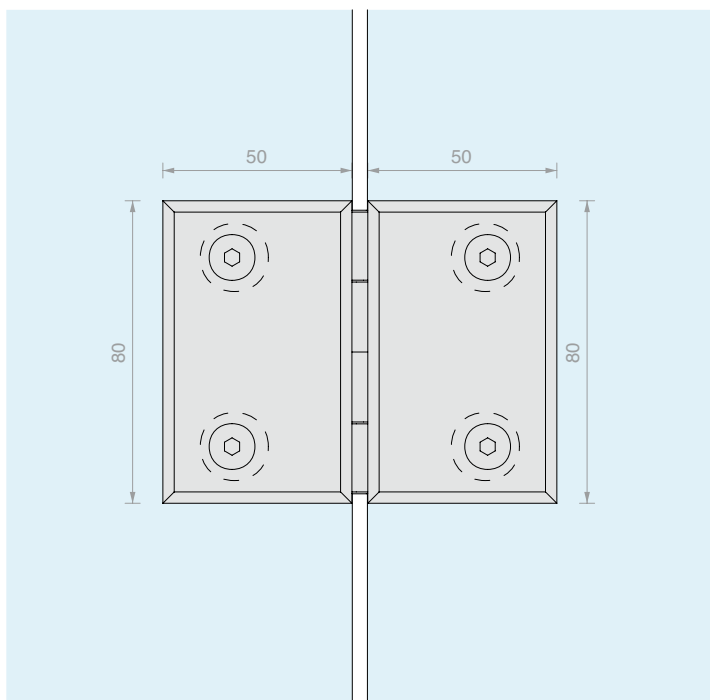
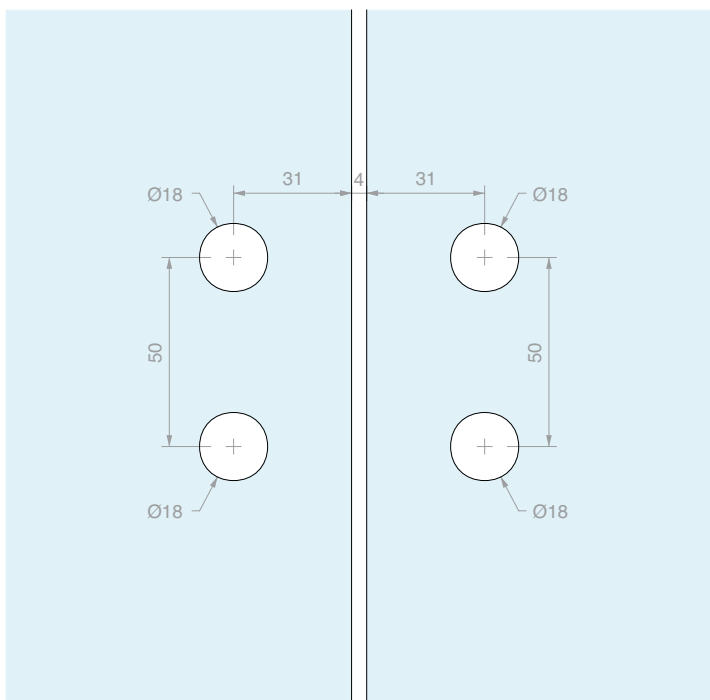
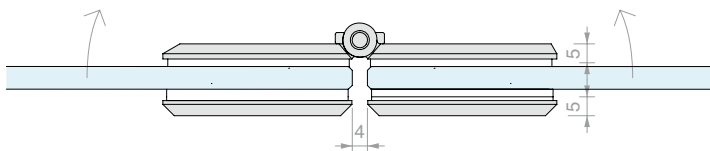
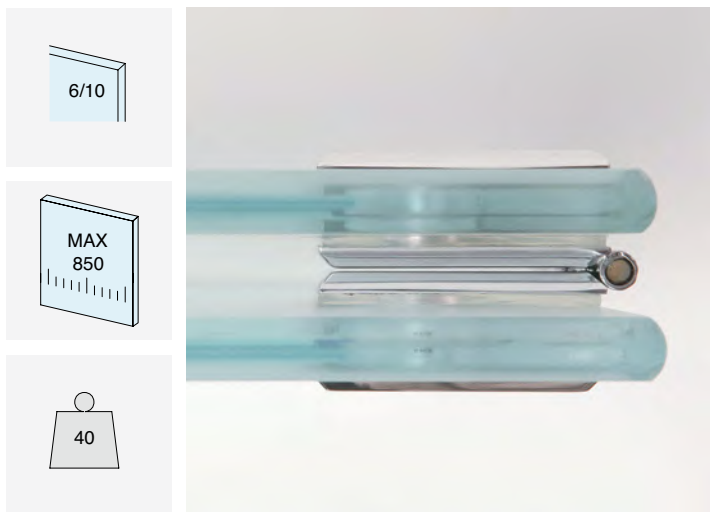

Art.	For glass	Qty
<b>CER33</b>	From 6 to 10 mm	1 Pc

**WALL/GLASS  
FLUSH TO THE WALL CLAMP**

Material: Brass

Finish: /1 /2 /3 /4

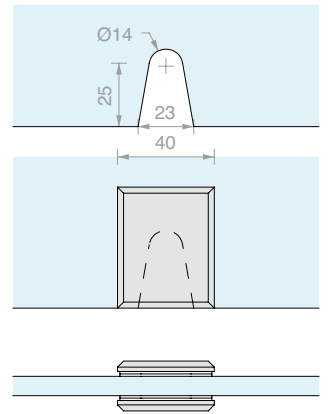
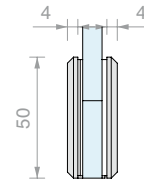

Art.	For glass	Qty
<b>MORS001</b>	From 6 to 10 mm	1 Pc

**WALL/GLASS SIDE FIXING CLAMP,  
NARROW**

Material: Brass

Finish: /1 /2 /3 /4

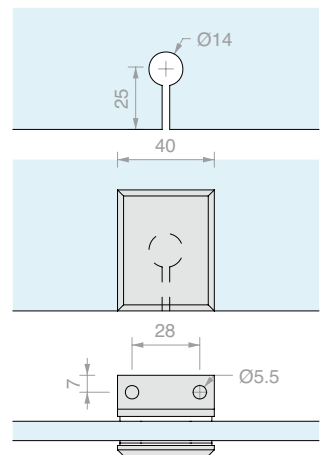
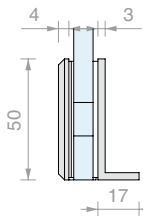

Art.	For glass	Qty
<b>MORS002</b>	From 6 to 10 mm	1 Pc

**WALL/GLASS SIDE FIXING CLAMP,  
LARGE**

Material: Brass

Finish: /1 /2 /3 /4

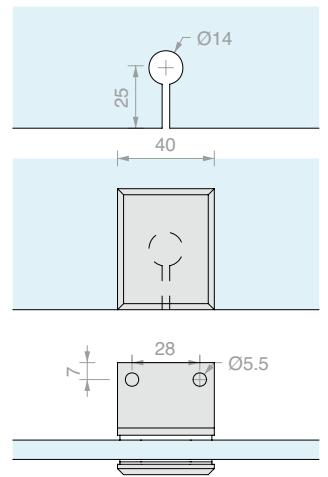
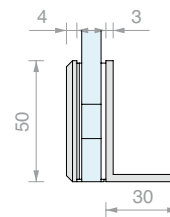

Art.	For glass	Qty
<b>MORS003</b>	From 6 to 10 mm	1 Pc

**WALL/GLASS  
FLUSH TO THE WALL CLAMP**

Material: Brass

Finish: /1 /2 /3 /4

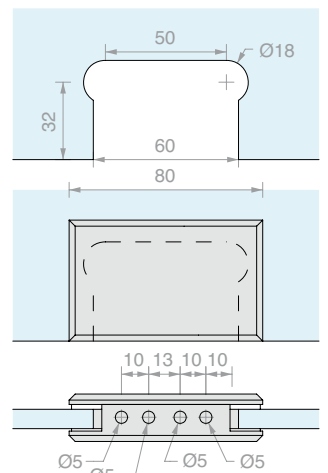
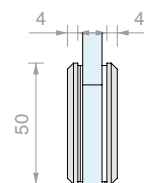

Art.	For glass	Qty
<b>MORS003</b>	From 6 to 10 mm	1 Pc

**WALL/GLASS SIDE FIXING CLAMP, LARGE**

Material: Brass

Finish: /1 /2 /3 /4

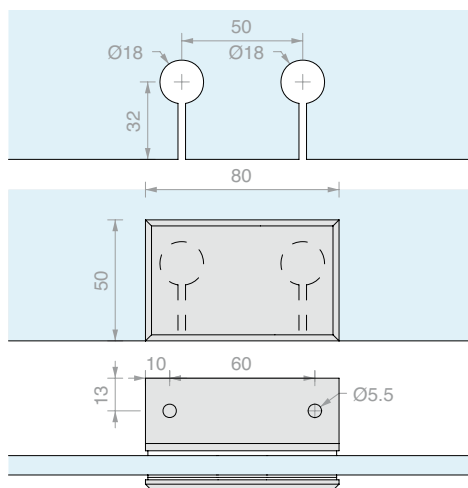
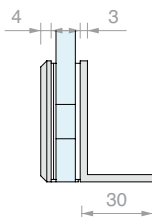

Art.	For glass	Qty
<b>MORS033</b>	From 6 to 10 mm	1 Pc

**GLASS/GLASS IN-LINE CLAMP**

Material: Brass

Finish: /1 /2 /3 /4

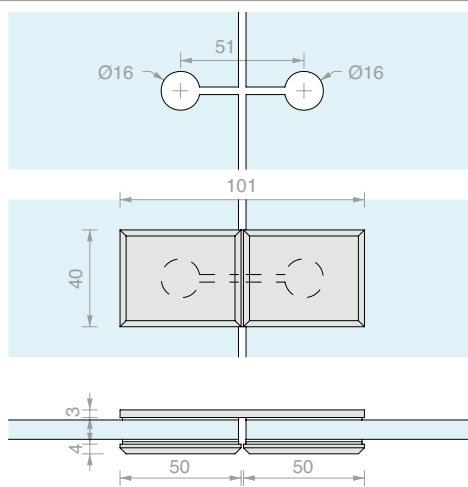

Art.	For glass	Qty
<b>MORS004</b>	From 6 to 10 mm	1 Pc

**GLASS/GLASS 90° CLAMP**

Material: Brass

Finish: /1 /2 /3 /4

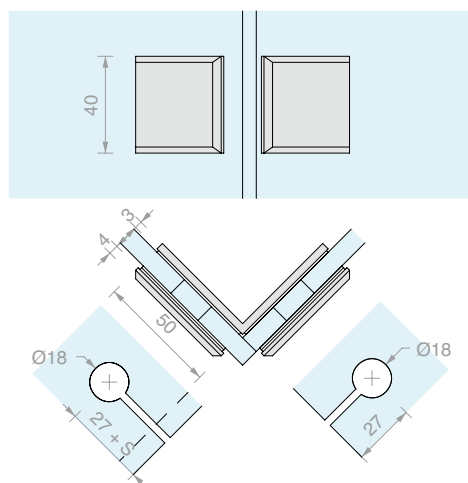

Art.	For glass	Qty
<b>MORS005</b>	From 6 to 10 mm	1 Pc

**45° FIXED WALL/GLASS STABILIZER BAR**

Material: Brass

Finish: /1 /24

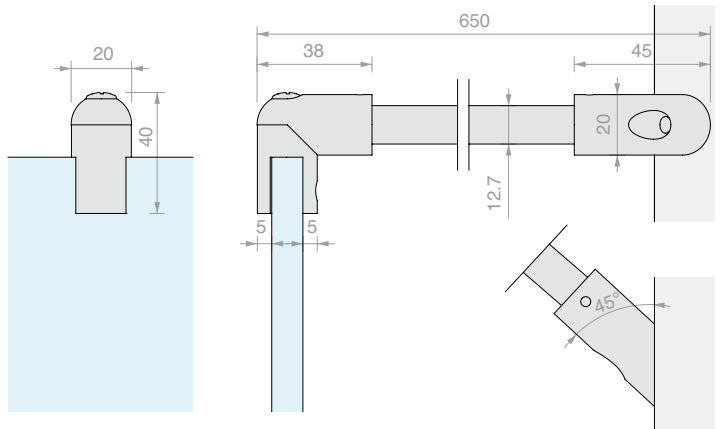

Art.	For glass	Qty
<b>MF129</b>	From 6 to 10 mm	1 Pc



**FIXED WALL/GLASS STABILIZER BAR**

Material: Brass

Finish: /1 /2 /4 /24

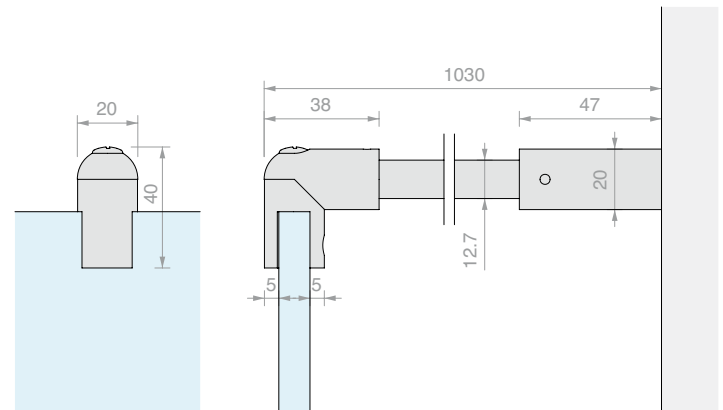

Art.	For glass	Qty
<b>MF127</b>	From 6 to 10 mm	1 Pc



**WALL/GLASS STABILIZER BAR WITH DOUBLE JOINT**

Material: Brass

Finish: /1 /2 /3 /4

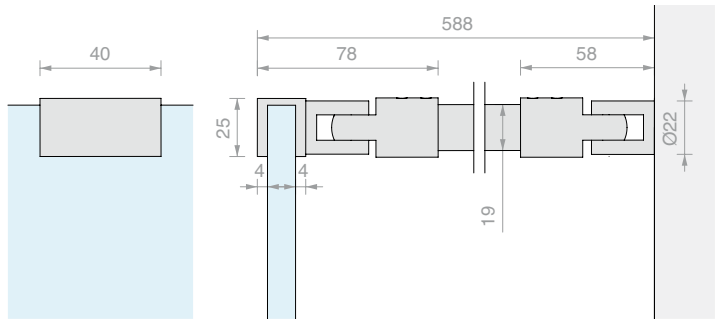

Art.	For glass	Qty
<b>MF1515</b>	From 6 to 12 mm	1 Pc

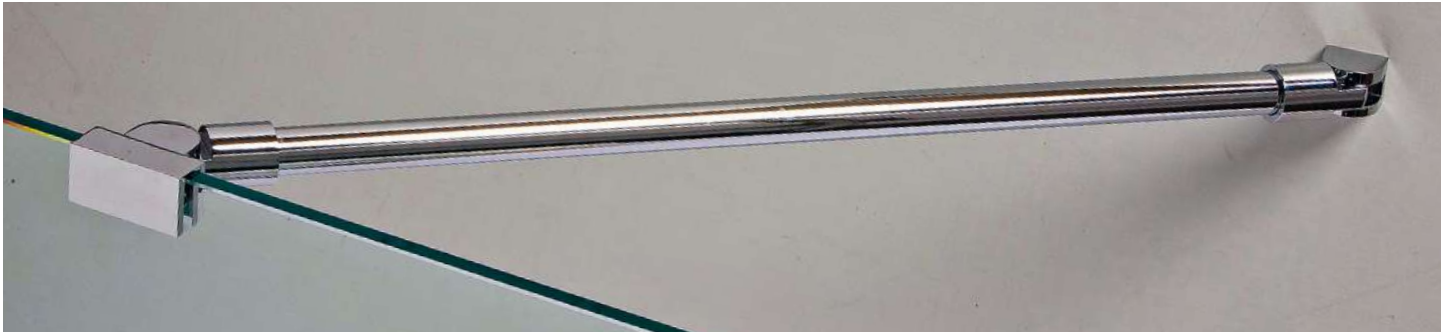

**WALL/GLASS FIXED STABILIZER BAR WITH SHORT CLAMP**

Material: Brass

Finish: /1 /2 /4 /24 /R2

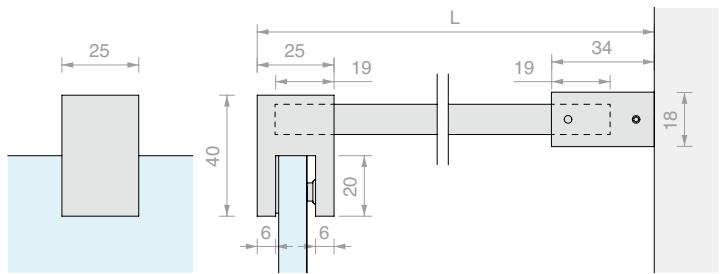

Art.	L	For glass	Qty
<b>DQT500</b>	520 mm	From 8 to 12 mm	1 Pc
<b>DQT1000</b>	1020 mm	From 8 to 12 mm	1 Pc
<b>DQT1500</b>	1520 mm	From 8 to 12 mm	1 Pc



**ARTICULATED DISTANCED GLASS FIXING**

Material: Brass

Finish: /1 /2 /4 /24 /R2

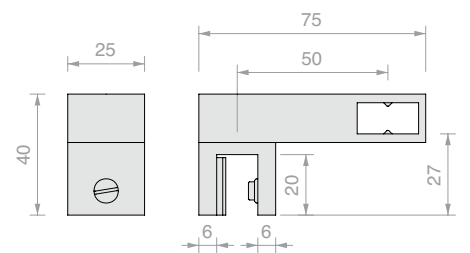

Art.	For glass	Qty
<b>DQA90</b>	From 8 to 12 mm	1 Pc



**PAIR OF SQUARE KNOBS WITH GRIP**

Material: Brass

Recommended glass hole minimum size Ø12 mm

Finish: /1 /2 /4 /24 /R2

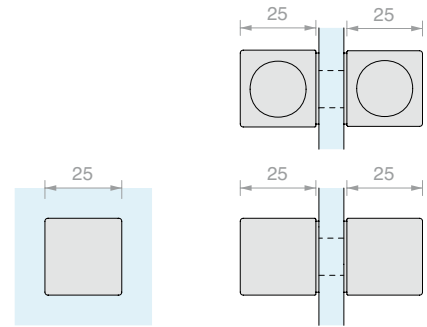

Art.	For glass	Qty
<b>DQTS2525</b>	From 8 to 12 mm	1 Pc



**PAIR OF SQUARE KNOBS**

Material: Brass

Recommended glass hole minimum size Ø8 mm

Finish: /1 /2 /3 /4 /R2

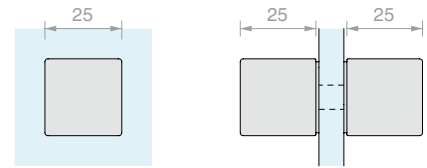

Art.	For glass	Qty
<b>DQP2525</b>	From 8 to 15 mm	1 Pc



**PAIR OF LONG KNOBS**

Material: Brass

Recommended glass hole minimum size Ø8 mm

Finish: /1 /2 /3 /4 /R2

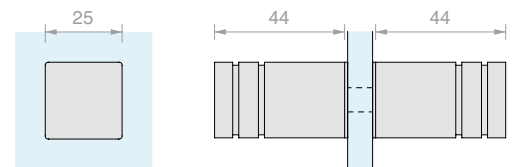

Art.	For glass	Qty
<b>POM2525</b>	From 8 to 15 mm	1 Pc





### LMU20B U-SHAPED PROFILE

Material: Brass

Finish: /1 /2 /4 /24 /R2

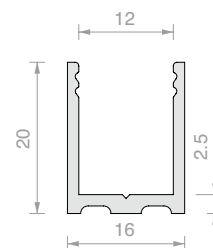

Art.	Length	Qty
<b>LMU20B.150</b>	1498 mm	1 Pc
<b>LMU20B.220</b>	2200 mm	1 Pc
<b>LMU20B.300</b>	3000 mm	1 Pc

### LMU86B FLAT UPPER PROFILE

Material: Brass

Finish: /1 /2 /4 /24 /R2

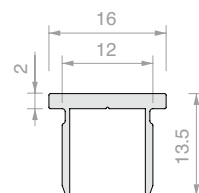

Art.	Length	Qty
<b>LMU86B.100</b>	992 mm	1 Pc
<b>LMU86B.150</b>	1498 mm	1 Pc
<b>LMU86B.300</b>	3000 mm	1 Pc

### FLAT CAP LMUB

Material: Brass

Finish: /1 /2 /4 /24 /R2

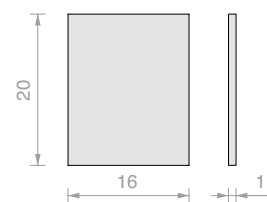

Art.	Qty
<b>LMU20TPB</b>	1 Pc

### WATER BARRIER PROFILE PESQ0810B

Material: Brass

Finish: /1 /2 /4 /24 /R2

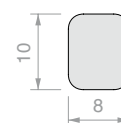

Art.	Length	Qty
<b>PESQ0810B.100</b>	992 mm	1 Pc
<b>PESQ0810B.150</b>	1498 mm	1 Pc
<b>PESQ0810B.300</b>	3000 mm	1 Pc



**PBD3183 U-SHAPED PROFILE**

Material: Aluminium  
 Finish: /6 /88 /91 /97

Art.	Length	Qty
<b>PBD3183.150</b>	1498 mm	1 Pc
<b>PBD3183.220</b>	2200 mm	1 Pc
<b>PBD3183</b>	3000 mm	1 Pc

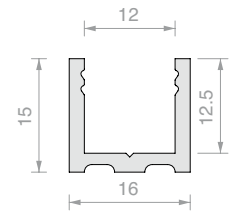

**ROUNDED UPPER PROFILE PBD3184**

Material: Aluminium  
 Finish: /6 /88 /91 /97

Art.	Length	Qty
<b>PBD3184.100</b>	992 mm	1 Pc
<b>PBD3184.150</b>	1498 mm	1 Pc
<b>PBD3184</b>	3000 mm	1 Pc

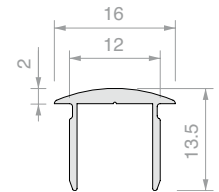

**ROUNDED CAP PBD**

Material: Aluminium  
 Finish: /6 /88 /91 /97

Art.	Qty
<b>PBDTP</b>	1 Pc

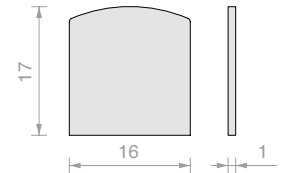

**FLAT UPPER PROFILE PBD3186**

Material: Aluminium  
 Finish: /6 /88 /91 /97

Art.	Length	Qty
<b>PBD3186.100</b>	992 mm	1 Pc
<b>PBD3186.150</b>	1498 mm	1 Pc
<b>PBD3186</b>	3000 mm	1 Pc

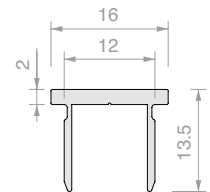

**PBD FLAT CAP**

Material: Aluminium  
 Finish: /6 /88 /91 /97

Art.	Qty
<b>PBD86TP</b>	1 Pc

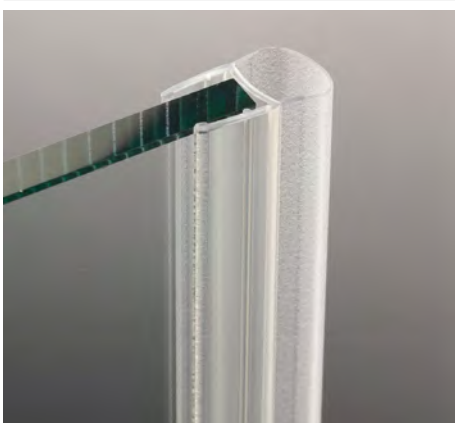
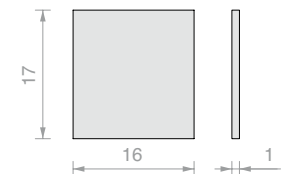

**BALLOON GASKET**

Material: Co-extruded rigid and soft PVC  
 Resistant to UV rays  
 Fungicide to prevent mould from forming  
 Colour: transparent/\*black, transparent balloon

Art.	Length	For glass	Qty
<b>GM06</b>	2000 mm	From 8 to 10 mm	1 Pc
<b>GM0622</b>	2200 mm	From 8 to 10 mm	1 Pc
<b>GM0622NR*</b>	2200 mm	From 8 to 10 mm	1 Pc
<b>GM0625</b>	2500 mm	From 8 to 10 mm	1 Pc
<b>GM0625NR*</b>	2500 mm	From 8 to 10 mm	1 Pc
<b>GM063000</b>	3000 mm	From 8 to 10 mm	1 Pc
<b>GM063000NR*</b>	3000 mm	From 8 to 10 mm	1 Pc

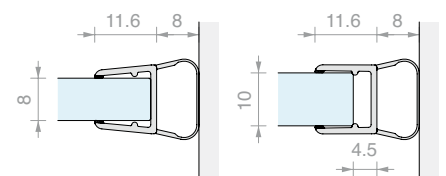

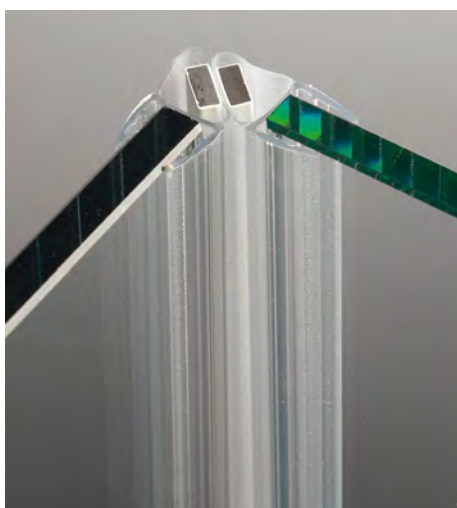

**MAGNETIC 45° GASKET**

Material: Co-extruded rigid and soft PVC  
 Resistant to UV rays  
 Fungicide to prevent mould from forming  
 Maximum operating temperature 70°C  
 Colour: transparent/\*black, transparent balloon, white/\*black magnet

Art.	Length	For glass	Qty
<b>GM1520SX</b>	2200 mm	From 8 to 10 mm	1 Pc
<b>GM1520SXNR*</b>	2200 mm	From 8 to 10 mm	1 Pc
<b>GM1520DX</b>	2200 mm	From 8 to 10 mm	1 Pc
<b>GM1520DXNR*</b>	2200 mm	From 8 to 10 mm	1 Pc
<b>GM15SX</b>	2500 mm	From 8 to 10 mm	1 Pc
<b>GM15DX</b>	2500 mm	From 8 to 10 mm	1 Pc
<b>GM1530SX</b>	3000 mm	From 8 to 10 mm	1 Pc
<b>GM1530DX</b>	3000 mm	From 8 to 10 mm	1 Pc

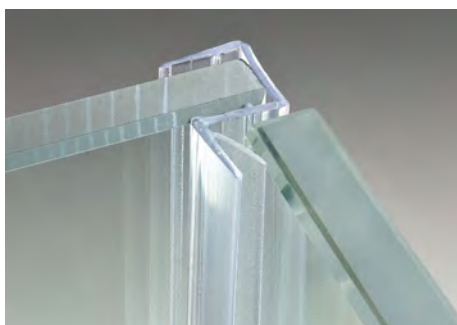
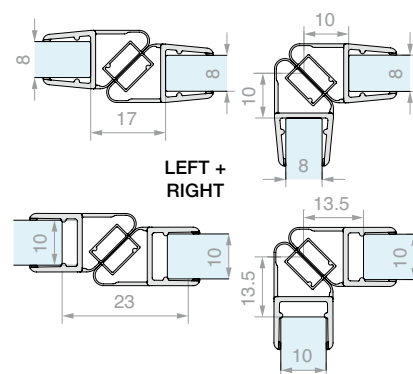

**90° STRIKE JAMB GASKET**

Material: Co-extruded rigid and soft PVC  
 Resistant to UV rays  
 Fungicide to prevent mould from forming  
 Maximum operating temperature 70°C  
 Colour: transparent, embossed lip

Art.	Length	For glass	Qty
<b>GM5422</b>	2200 mm	From 8 to 10 mm	1 Pc
<b>GM5430</b>	3000 mm	From 8 to 10 mm	1 Pc

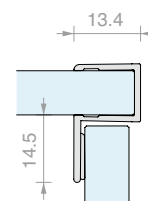

**GASKET WITH LIP WATER BARRIER AND DRIP FLAP**

Material: Co-extruded rigid and soft PVC  
 Resistant to UV rays  
 Fungicide to prevent mould from forming  
 Maximum operating temperature 70°C  
 Colour: transparent/\*black, embossed lip

Art.	Length	For glass	Qty
<b>GM0210</b>	1000 mm	From 8 to 10 mm	1 Pc
<b>GM02</b>	2000 mm	From 8 to 10 mm	1 Pc
<b>GM02NR*</b>	2000 mm	From 8 to 10 mm	1 Pc
<b>GM022500</b>	2500 mm	From 8 to 10 mm	1 Pc
<b>GM022500NR*</b>	2500 mm	From 8 to 10 mm	1 Pc

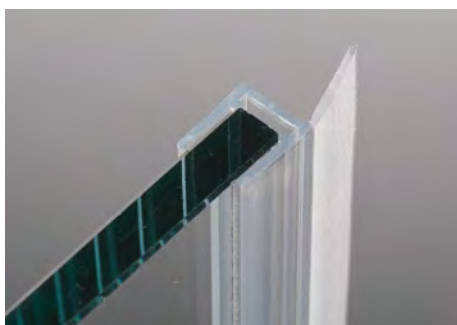
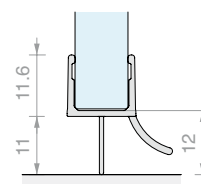

**GASKET WITH STRAIGHT LIP**

Material: Co-extruded rigid and soft PVC  
 Fungicide to prevent mould from forming  
 Colour: transparent, embossed lip

Art.	Length	For glass	Qty
<b>GM04</b>	2000 mm	From 8 to 10 mm	1 Pc
<b>GM0422</b>	2200 mm	From 8 to 10 mm	1 Pc
<b>GM0425</b>	2500 mm	From 8 to 10 mm	1 Pc
<b>GM0430</b>	3000 mm	From 8 to 10 mm	1 Pc

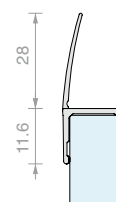

**GLASS HOLDER GASKET**

Material: PVC

Art.	Thickness	Colour	Qty	Art.	Thickness	Colour	Qty
<b>GTUP2</b>	2	Transparent	1 m	<b>GTUP5G</b>	5	Embossed	1 m
<b>GTUP3</b>	3	Transparent	1 m	<b>GTUP6G</b>	6	Embossed	1 m
<b>GTUP4</b>	4	Transparent	1 m	<b>GTUP2N</b>	2	Black	1 m
<b>GTUP5</b>	5	Transparent	1 m	<b>GTUP3N</b>	3	Black	1 m
<b>GTUP6</b>	6	Transparent	1 m	<b>GTUP4N</b>	4	Black	1 m
<b>GTUP2G</b>	2	Embossed	1 m	<b>GTUP5N</b>	5	Black	1 m
<b>GTUP3G</b>	3	Embossed	1 m	<b>GTUP6N</b>	6	Black	1 m
<b>GTUP4G</b>	4	Embossed	1 m				

# ACCESSORIES FOR SHOWER PARTITIONS





**PIVOT SHOWER**  
Page 358



**HINGES**  
Page 370



**LOCK WITHOUT HOLES**  
Page 392



**STABILIZER BARS**  
Page 395

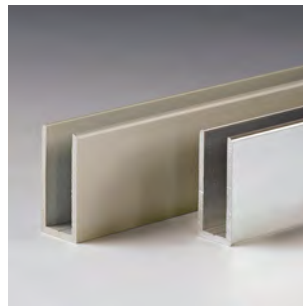

**PROFILES**  
Page 404



**CLAMPS AND KNOBS**  
Page 418



**DOOR STRIKER PROFILES**  
Page 419



**GASKETS**  
Page 420

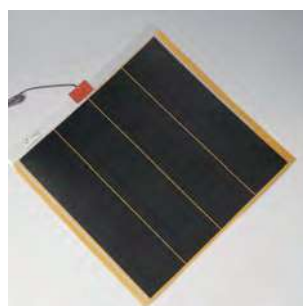

**STOPVAPOR**  
Page 437



**MIRROR SUPPORTS**  
Page 438



WALL/WALL PIVOT-UP SQUARE SHOWER KIT

Material: Aluminium

Finish: /6 /91

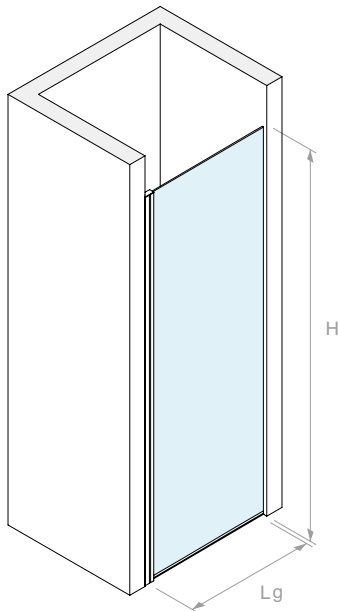

Kit comprising:

Art.	Description	Qty.
<b>PTUPSQ-11</b>	Extension profile	1 Pc
<b>PTUPSQ-61C</b>	Hinge anchoring profile	1 Pc
<b>PTUPSQ-66</b>	Glass holder profile	1 Pc
<b>PTUPSQGUAV</b>	V-shaped gasket	1 Pc
<b>PTUPSQACCM</b>	Wall/glass mounting kit	1 Pc
<b>PTUPSQD</b>	Water barrier profile	1 Pc
<b>GM6010</b>	Gasket with drip flap	1 Pc
Optional		
<b>BT3322</b>	Magnetic 45° door striker	1 Pc

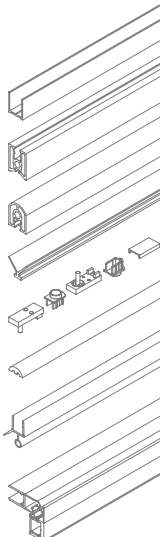

Kit comprising:

Art.	Description	Qty.
<b>PTUPSQ-11</b>	Extension profile	1 Pc
<b>PTUPSQ-81C</b>	Hinge anchoring profile	1 Pc
<b>PTUPSQ-88</b>	Glass holder profile	1 Pc
<b>PTUPSQGUAV</b>	V-shaped gasket	1 Pc
<b>PTUPSQACCM</b>	Wall/glass mounting kit	1 Pc
<b>PTUPSQD</b>	Water barrier profile	1 Pc
<b>GM6010</b>	Gasket with drip flap	1 Pc
Optional		
<b>BT3322</b>	Magnetic 45° door striker	1 Pc

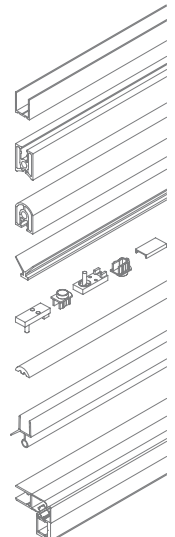

Art.	Qty
<b>PTUPSQ2016</b>	1 Pc

Art.	Qty
<b>PTUPSQ2018</b>	1 Pc

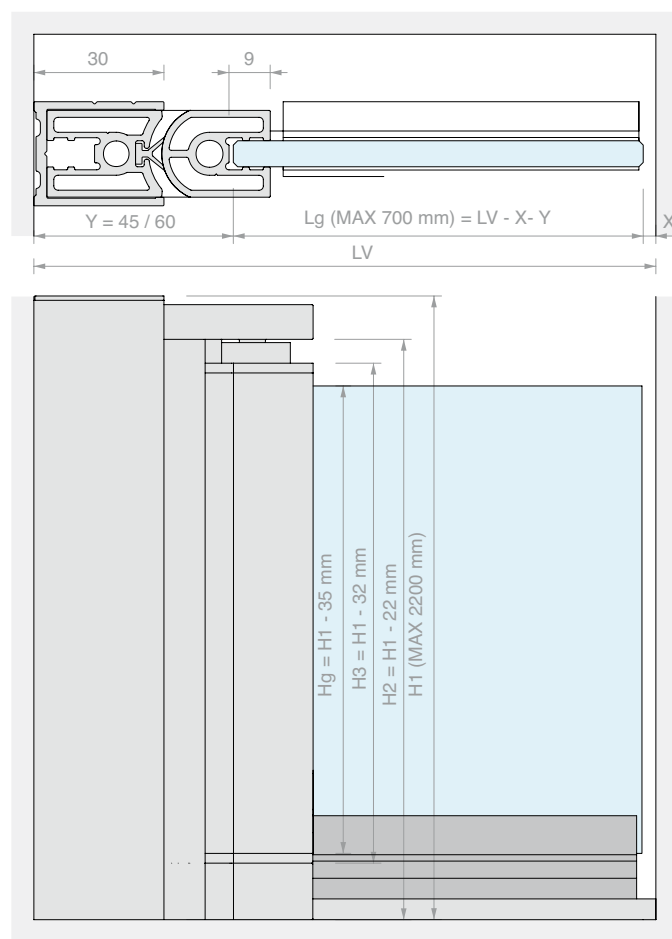
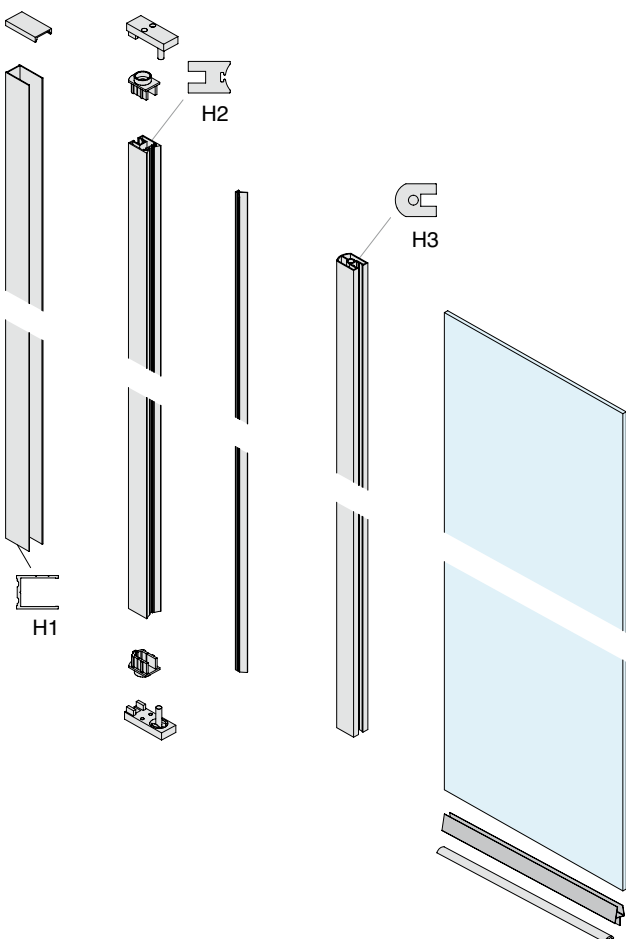



**WALL/GLASS PIVOT-UP SQUARE SHOWER KIT**

Material: Aluminium

Finish: /6 /91

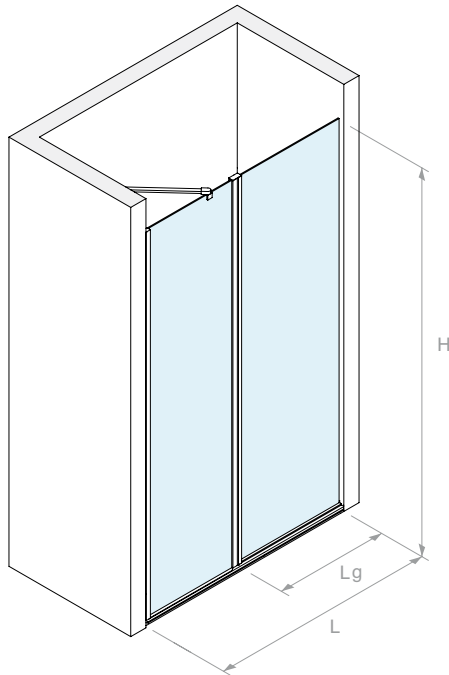

LgMAX 700
LfMAX 600
HMAX 2200
30
90°(MAX)
90°(MAX)
UP



Kit comprising:

Art.	Description	Qty.
<b>PTUPSQ-11</b>	Extension profile	1 Pc
<b>PTUPSQ-61C</b>	Hinge anchoring profile	1 Pc
<b>PTUPSQ-61L</b>	Fixed pane anchoring profile	1 Pc
<b>PTUPSQ-66</b>	Glass holder profile	1 Pc
<b>PTUPSQGUAV</b>	V-shaped gasket	1 Pc
<b>PTUPSQACCV</b>	Glass/glass mounting kit	1 Pc
<b>PBD3183.150</b>	U-shaped profile	1 Pc
<b>GTUP3</b>	Glass holder gasket	1 Pc
<b>PTUPSQD</b>	Water barrier profile	1 Pc
<b>GM6010</b>	Gasket with drip flap	1 Pc
<b>MF350</b>	Jointed stabilizer bar	1 Pc
Optional		
<b>BT3322</b>	Magnetic 45° door striker	1 Pc

Art. **PTUPSQ2036** Qty 1 Pc

Kit comprising:

Art.	Description	Qty.
<b>PTUPSQ-11</b>	Extension profile	1 Pc
<b>PTUPSQ-81C</b>	Hinge anchoring profile	1 Pc
<b>PTUPSQ-81L</b>	Fixed pane anchoring profile	1 Pc
<b>PTUPSQ-88</b>	Glass holder profile	1 Pc
<b>PTUPSQGUAV</b>	V-shaped gasket	1 Pc
<b>PTUPSQACCV</b>	Glass/glass mounting kit	1 Pc
<b>PBD3183.150</b>	U-shaped profile	1 Pc
<b>GTUP2</b>	Glass holder gasket	1 Pc
<b>PTUPSQD</b>	Water barrier profile	1 Pc
<b>GM6010</b>	Gasket with drip flap	1 Pc
<b>MF350</b>	Jointed stabilizer bar	1 Pc
Optional		
<b>BT3322</b>	Magnetic 45° door striker	1 Pc

Art. **PTUPSQ2038** Qty 1 Pc



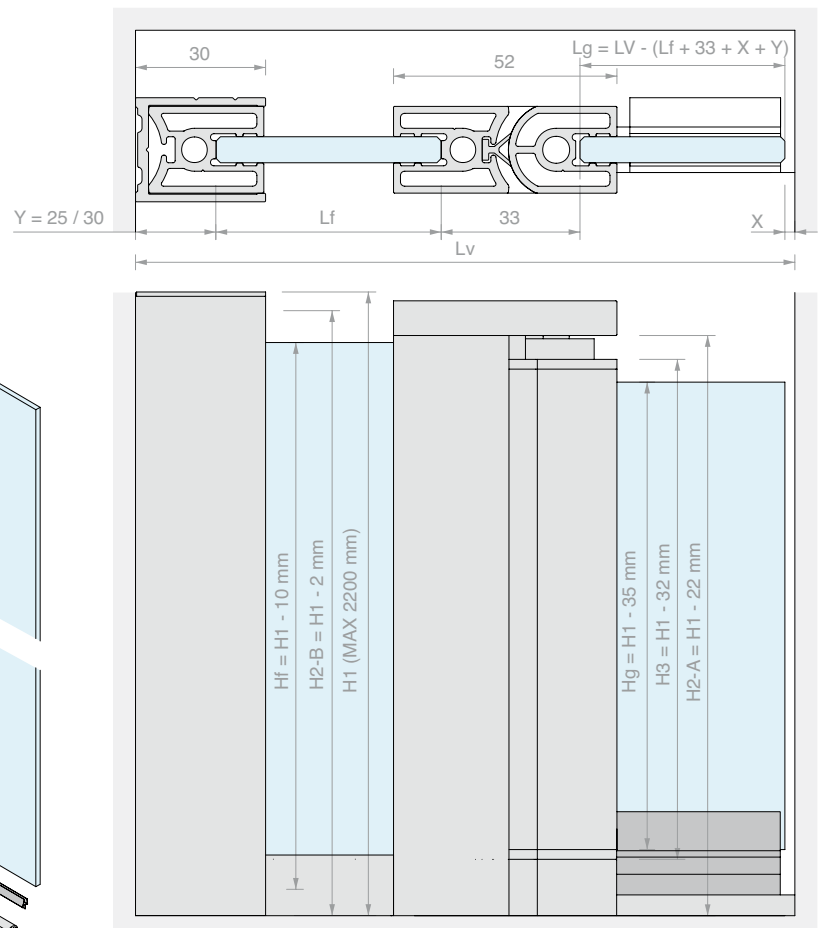
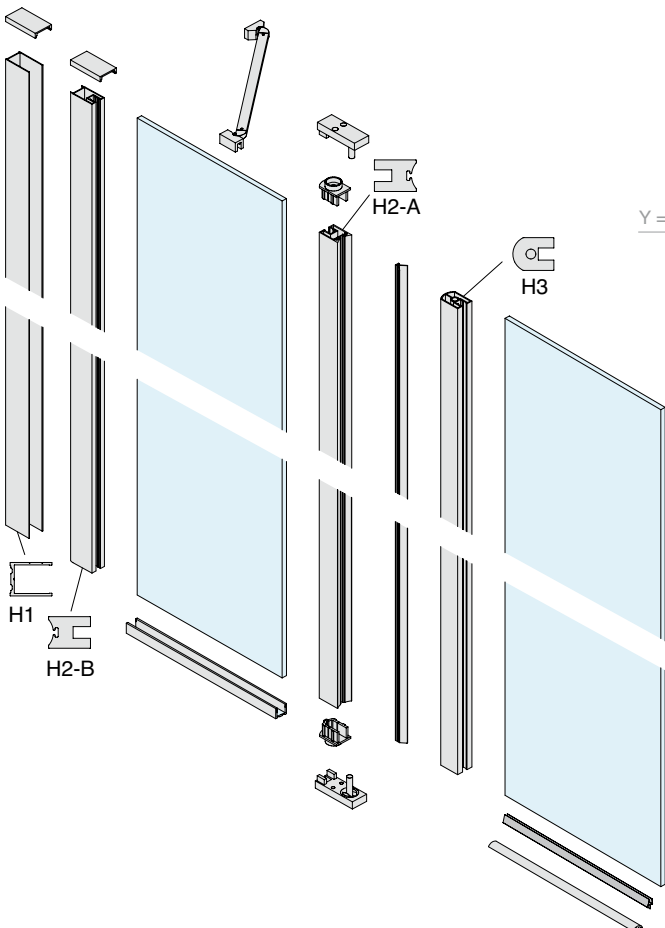



**EXTENSION PROFILE**

Material: Aluminium

Finish: /6 /91

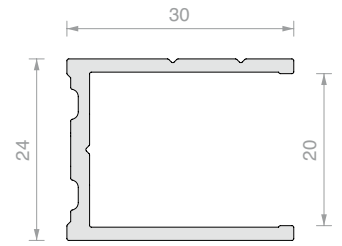

Art.	Length	Qty
<b>PTUPSQ-11</b>	2200 mm	1 Pc
<b>PTUPSQ-1130</b>	3000 mm	1 Pc



**HINGE ANCHORING PROFILE**

Material: Aluminium

Finish: /6 /91

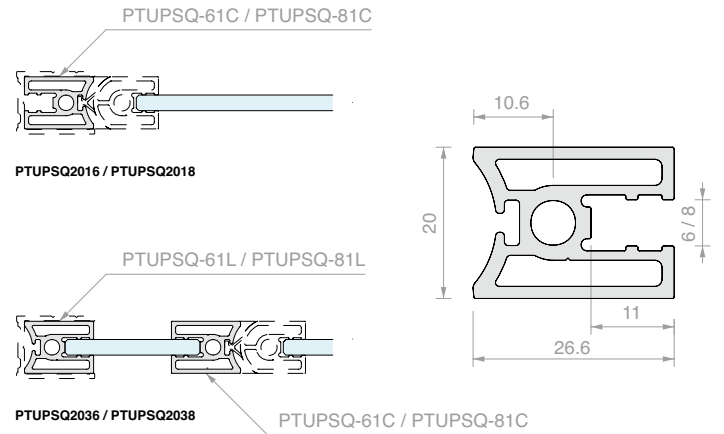

Art.	Length	For glass	Qty
<b>PTUPSQ-61C</b>	2178 mm	6 mm	1 Pc
<b>PTUPSQ-61L</b>	2198 mm	6 mm	1 Pc
<b>PTUPSQ-81C</b>	2178 mm	8 mm	1 Pc
<b>PTUPSQ-81L</b>	2198 mm	8 mm	1 Pc
<b>PTUPSQ-6130</b>	3000 mm	6 mm	1 Pc
<b>PTUPSQ-8130</b>	3000 mm	8 mm	1 Pc



**GLASS HOLDER PROFILE**

Material: Aluminium

Finish: /6 /91

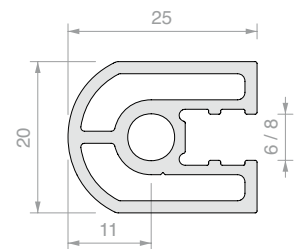

Art.	Length	For glass	Qty
<b>PTUPSQ-66</b>	2168 mm	6 mm	1 Pc
<b>PTUPSQ-6630</b>	3000 mm	6 mm	1 Pc
<b>PTUPSQ-88</b>	2168 mm	8 mm	1 Pc
<b>PTUPSQ-8830</b>	3000 mm	8 mm	1 Pc



**V-SHAPED GASKET**

Material: PVC  
Colour: Embossed

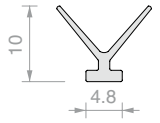

Art.	Length	Qty
<b>PTUPSQGUAV</b>	2178 mm	1 Pc



**PTUPSQ WALL/GLASS MOUNTING ACCESSORIES KIT**

Finish: /15 /R2

Art.	Qty
<b>PTUPSQACCM</b>	1 Pc



**PTUPSQ GLASS/GLASS MOUNTING ACCESSORIES KIT**

Finish: /15 /R2

Art.	Qty
<b>PTUPSQACCV</b>	1 Pc



**WALL/GLASS STABILIZER BAR WITH DOUBLE JOINT**

Material: aluminium bar, Zamak accessories  
Finish: /1

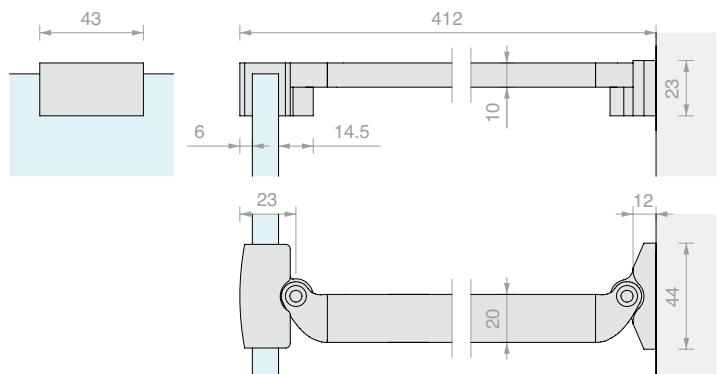

Art.	For glass	Qty
<b>MF350</b>	From 6 to 8 mm	1 Pc



**PBD3183 U-SHAPED PROFILE**

Material: Aluminium

Finish: /6 /88 /91 /97

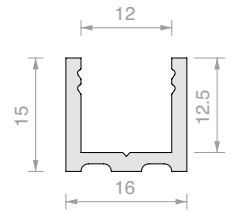

Art.	Length	Qty
<b>PBD3183.150</b>	1498 mm	1 Pc
<b>PBD3183.220</b>	2200 mm	1 Pc
<b>PBD3183</b>	3000 mm	1 Pc



**SQ WATER BARRIER PROFILE**

Material: Aluminium

Finish: /6 /91

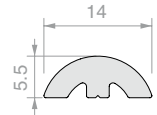

Art.	Length	Qty
<b>PTUPSQD</b>	1000 mm	1 Pc



**UP WATER BARRIER PROFILE**

Material: Aluminium

Finish: /91

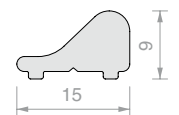

Art.	Length	Qty
<b>PTUP26</b>	2000 mm	1 Pc



**CORNER PROFILE FOR SQ WATER BARRIER**

Material: Aluminium

Finish: /91 /R2

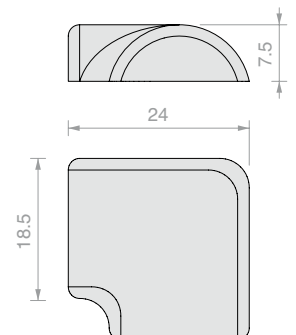

Art.	Qty
<b>PTUPSQANG</b>	1 Pc



**CORNER PROFILE FOR UP WATER BARRIER**

Material: Plastic

Finish: /1

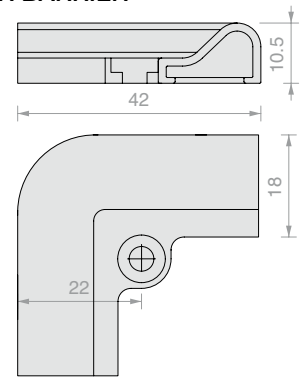

Art.

**PTUP30**

Q.ty

1 Pc



**MAGNETIC 45° DOOR STRIKER PROFILE WITH COVER**

Material: Aluminium, magnet

Finish: /6 /88 /91 /97

Supplied with magnetic gasket for glass thickness 6–8 mm

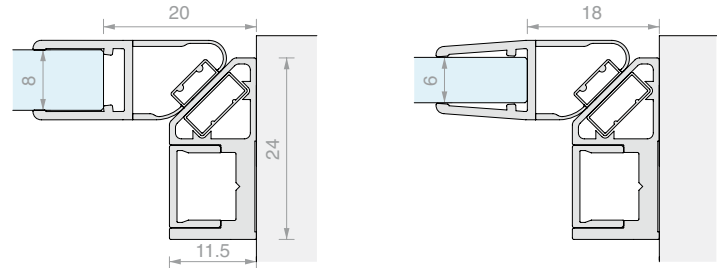

Art.

**BT3322**

Length

2200 mm

Qty

1 Pc

**BT3325**

2500 mm

1 Pc

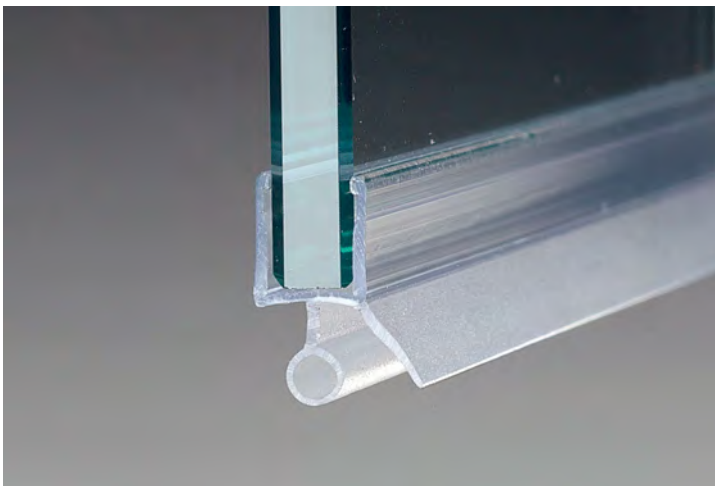

**GASKET WITH BALLOON WATER BARRIER AND DRIP FLAP**

Material: Co-extruded rigid and soft PVC

Maximum operating temperature 70°C

Colour: transparent, embossed lip and balloon

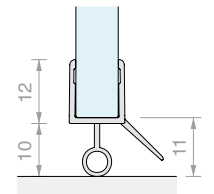

Art.

**GM6010**

Length

1000 mm

For glass

From 6 to 8 mm

Qty

1 Pc

**GM6020**

2000 mm

From 6 to 8 mm

1 Pc

**GM6025**

2500 mm

From 6 to 8 mm

1 Pc

**GM6030**

3000 mm

From 6 to 8 mm

1 Pc

**GLASS HOLDER GASKET**

Material: PVC



Art.

**GTUP2**

Thickness

2 mm

Colour

Transparent

1 m

**GTUP3**

3 mm

Transparent

1 Pc

**GTUP4**

4 mm

Transparent

1 Pc

**GTUP5**

5 mm

Transparent

1 Pc

**GTUP6**

6 mm

Transparent

1 Pc

**GTUP2G**

2 mm

Embossed

1 Pc

**GTUP3G**

3 mm

Embossed

1 Pc

**GTUP4G**

4 mm

Embossed

1 Pc

**GTUP5G**

5 mm

Embossed

1 Pc

**GTUP6G**

6 mm

Embossed

1 Pc

**GTUP2N**

2 mm

Black

1 Pc

**GTUP3N**

3 mm

Black

1 Pc

**GTUP4N**

4 mm

Black

1 Pc

**GTUP5N**

5 mm

Black

1 Pc

**GTUP6N**

6 mm

Black

1 Pc



**WALL/WALL PIVOT-UP 2261 SHOWER KIT**

Material: Aluminium and Zamak

Finish: /91

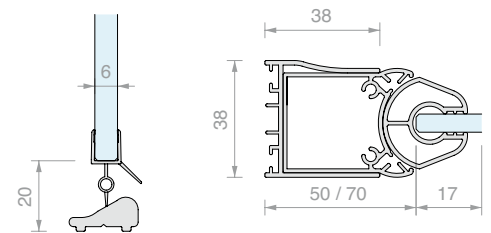
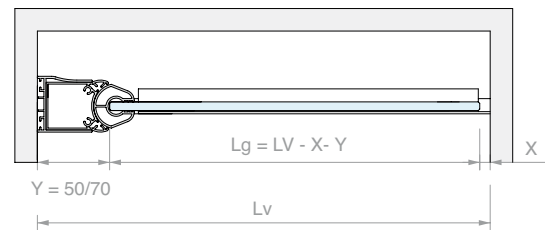
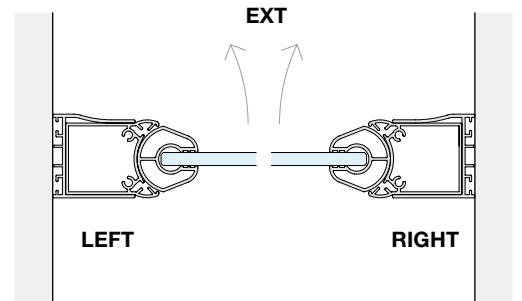
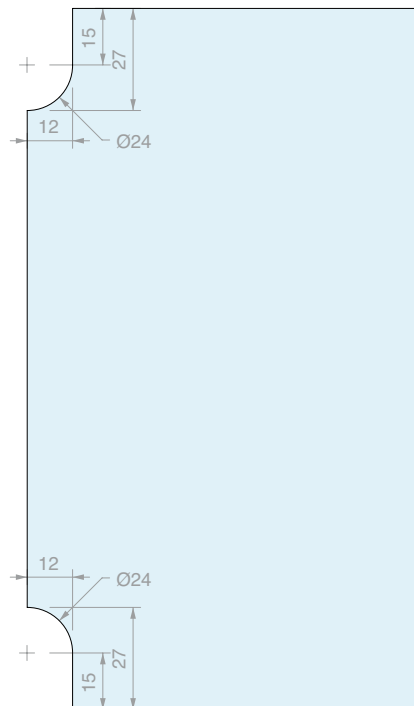
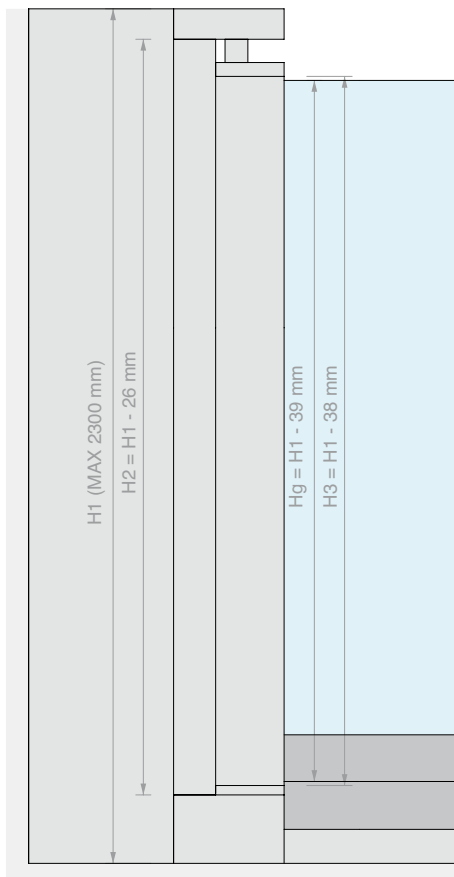
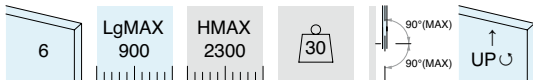
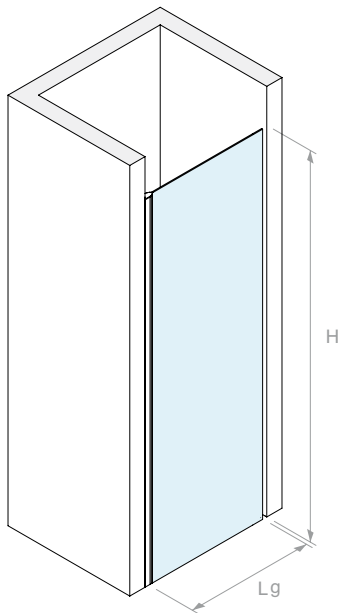

Art.	Description	Qty
<b>PTUP2261-SX</b>	Left	1 Pc
<b>PTUP2261-DX</b>	Right	1 Pc

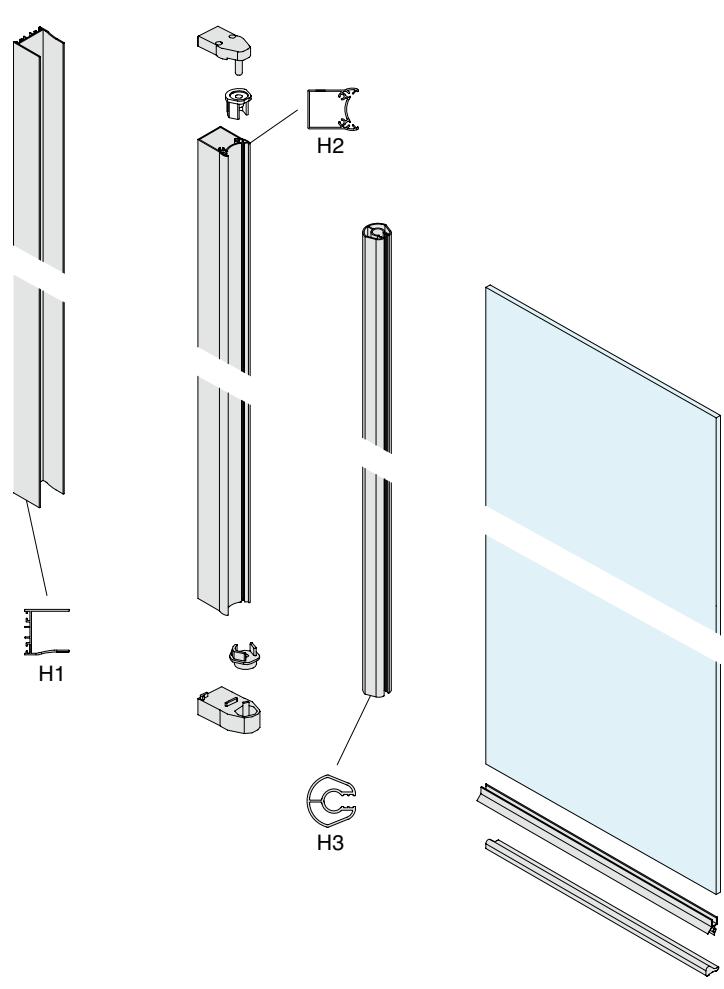



**FULL-HEIGHT HINGE FOR BATHTUB EDGE**

Material: Aluminium and Zamak

Finish: /91

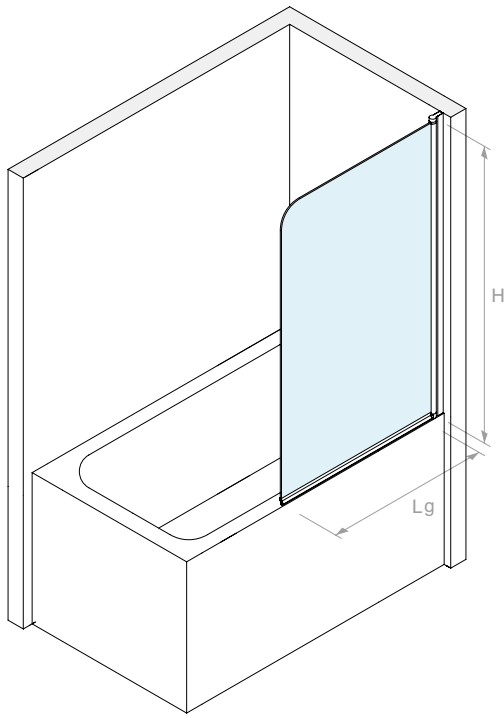

LgMAX  
800

HMAX  
1500

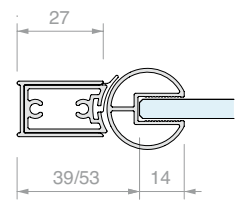
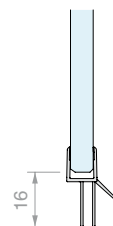
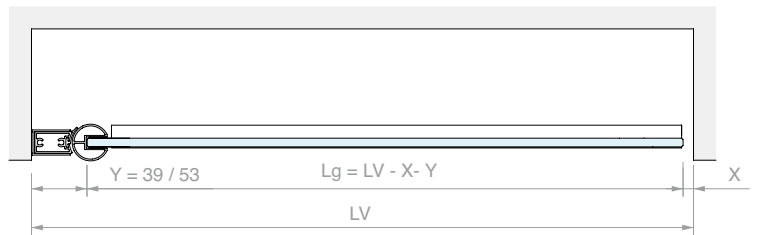
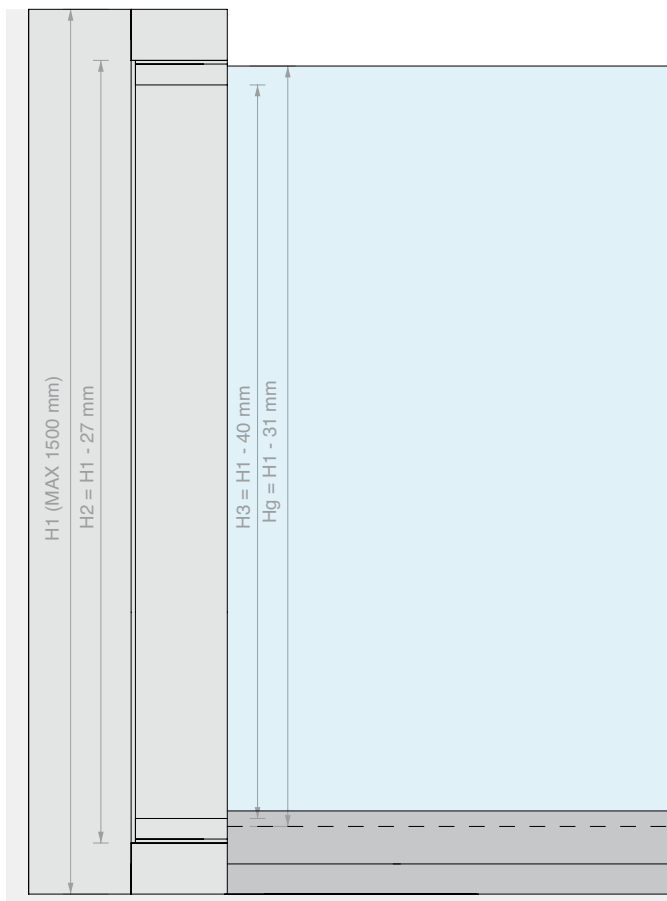

Art.  
**PTBH1964**

Qty  
1 Pc



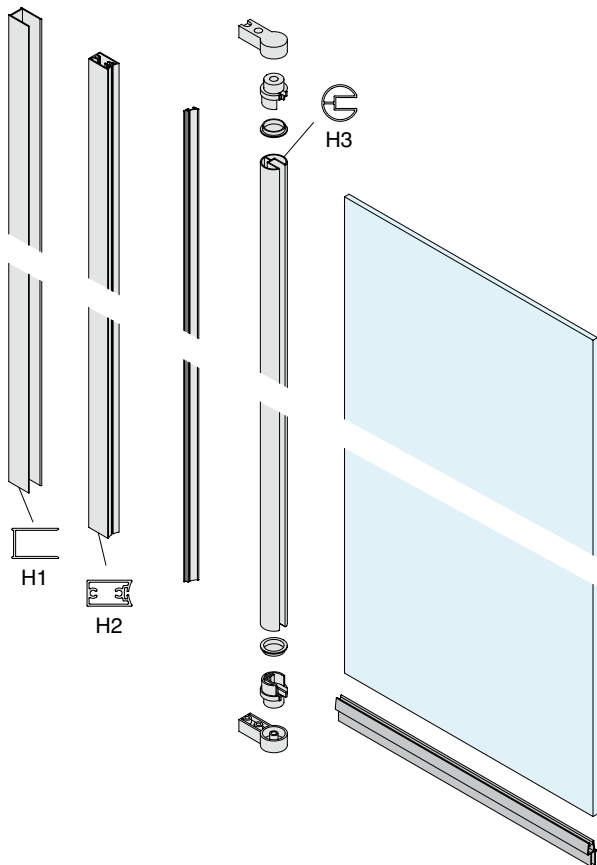

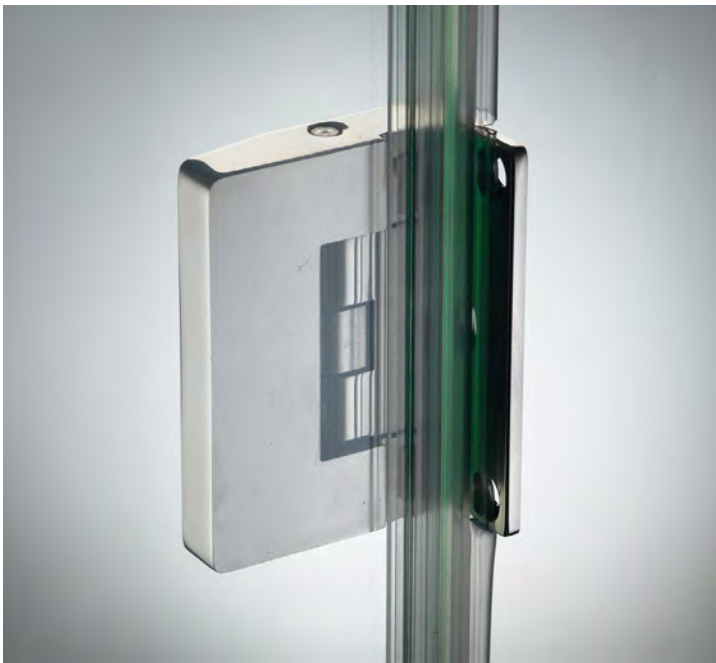

### WALL/GLASS ADJUSTABLE SIDE HINGE UV BONDING



Material: AISI 316 stainless steel

Finish: /8 /15

Recommended adhesive: Float/Tempered/Laminated

FIXGLASS UV 621

FIXGLASS UV 973/973 GEL (for high-humidity environments)

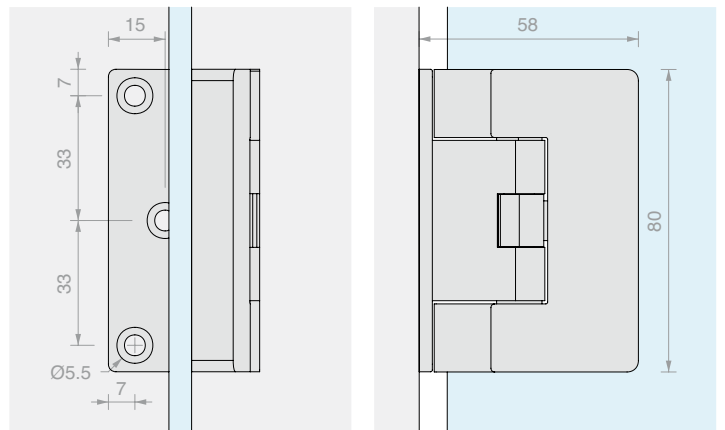
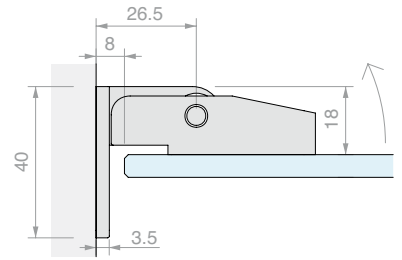
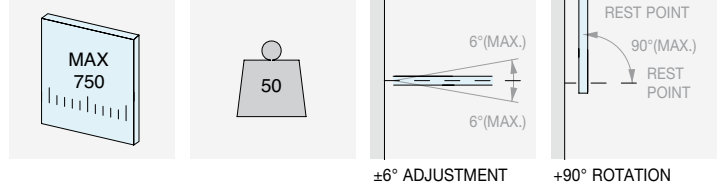

Art.	For glass	Qty
<b>CER700UV</b>	From 8 mm	1 Pc

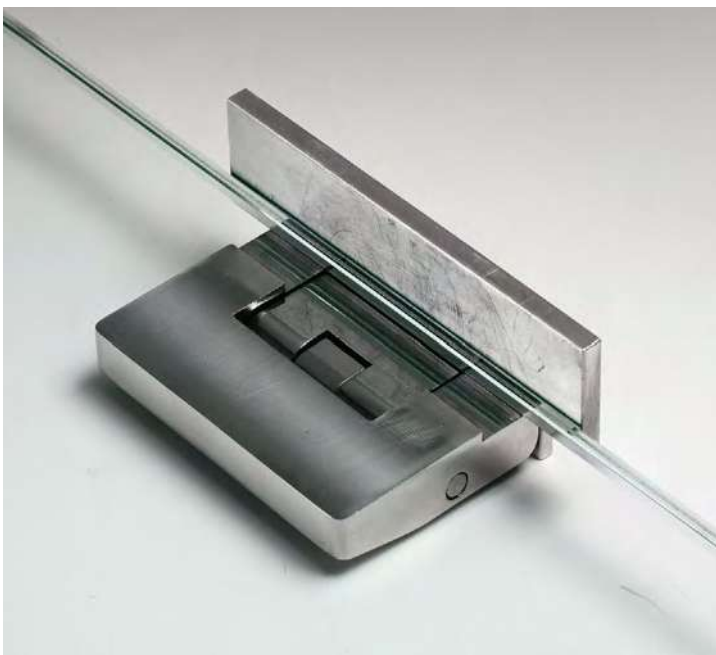

### CER700UV-CER720UV MOUNTING TEMPLATE

Material: AISI 304 stainless steel

Finish: /8



Art.	Qty
<b>FXGAB01</b>	1 Pc

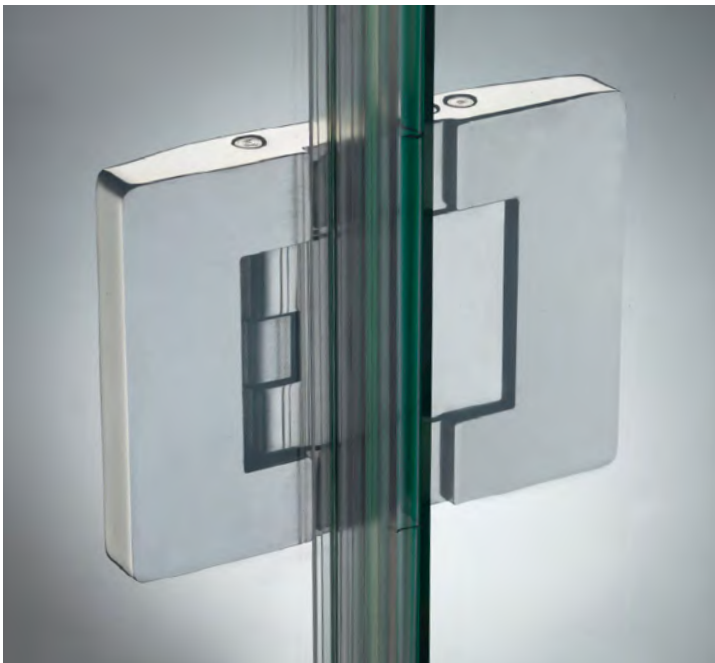

**GLASS/GLASS ADJUSTABLE IN-LINE HINGE  
UV BONDING**



Material: AISI 316 stainless steel

Finish: /8 /15

Recommended adhesive: Float/Tempered/Laminated

FIXGLASS UV 621

FIXGLASS UV 973/973 GEL (for high-humidity environments)

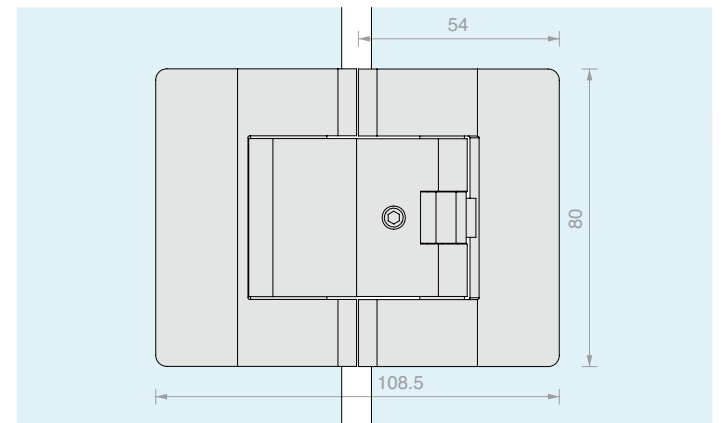
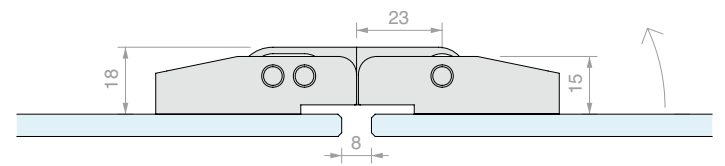
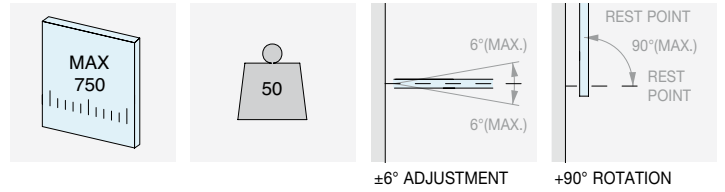

Art.	For glass	Qty
<b>CER720UV</b>	From 8 mm	1 Pc

CER700UV HINGE MOUNTING DIAGRAM

CER720UV HINGE MOUNTING DIAGRAM

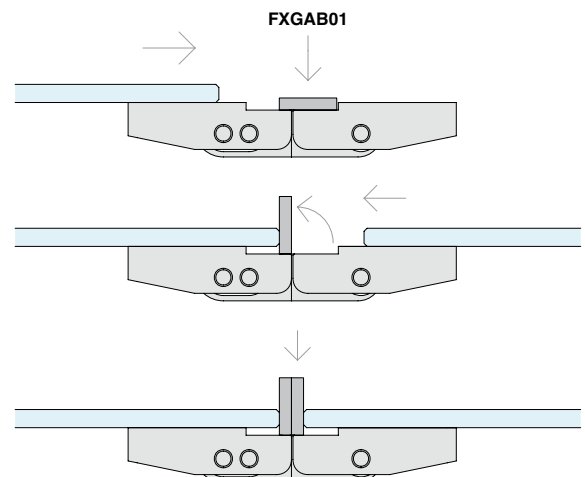
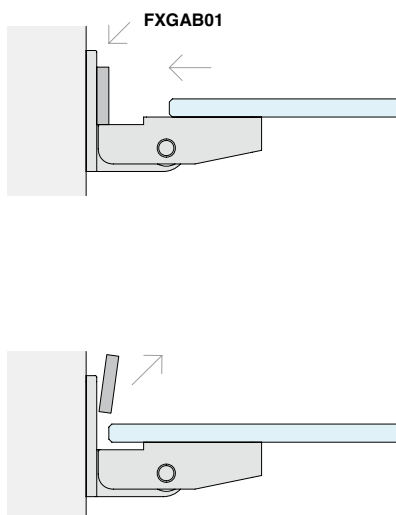



**WALL/GLASS ADJUSTABLE SIDE HINGE WITH PULL OPENING**

Material: Brass

Finish: /1 /3

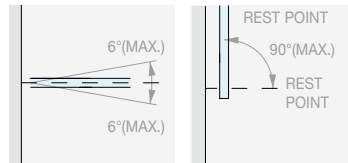
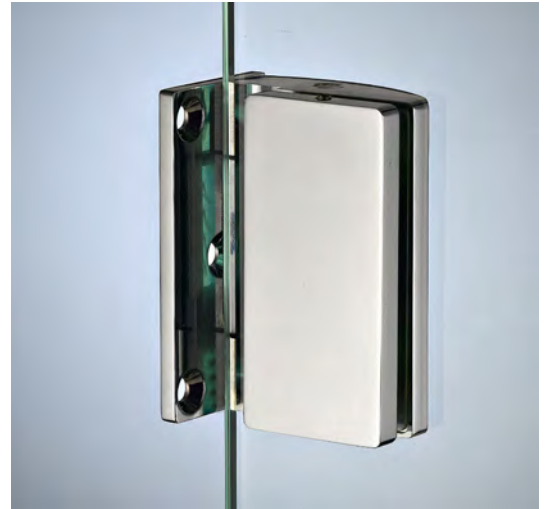
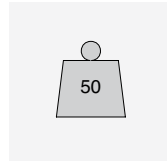
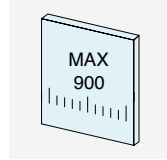
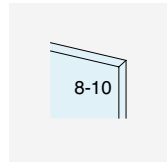

±6° ADJUSTMENT

+90° ROTATION

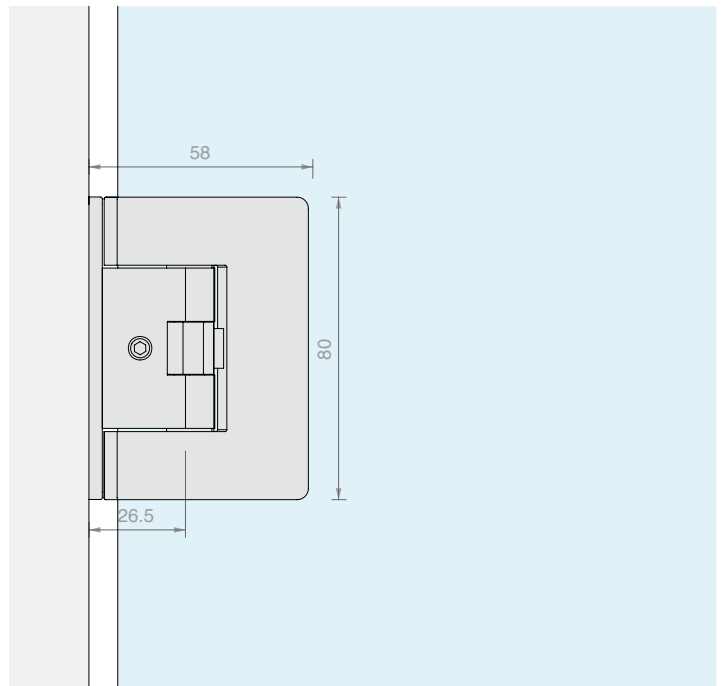
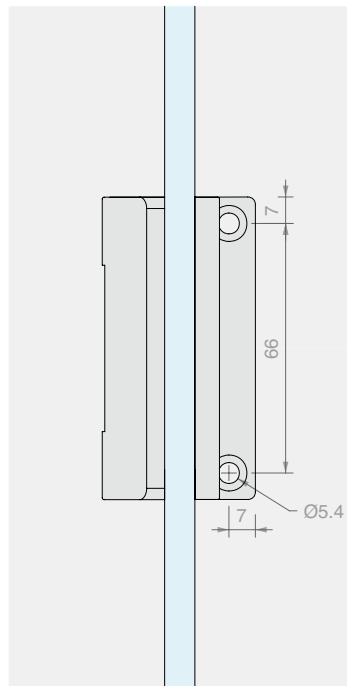
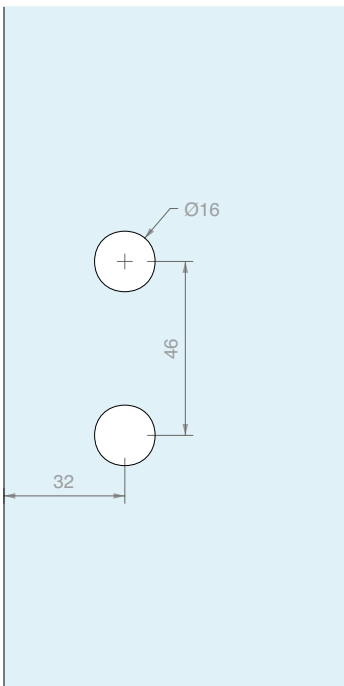
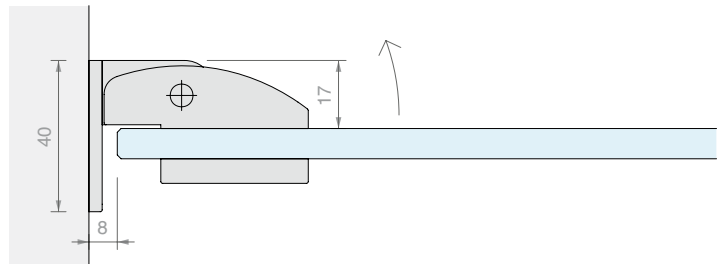

Art.  
**CER700**

For glass  
From 8 to 10 mm

Qty  
1 Pc



**GLASS/GLASS ADJUSTABLE IN-LINE HINGE WITH PULL OPENING**

Material: Brass

Finish: /1 /3

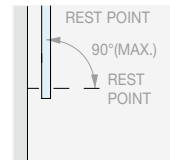
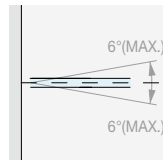
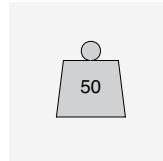
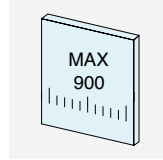
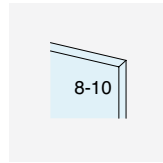

±6° ADJUSTMENT      +90° ROTATION

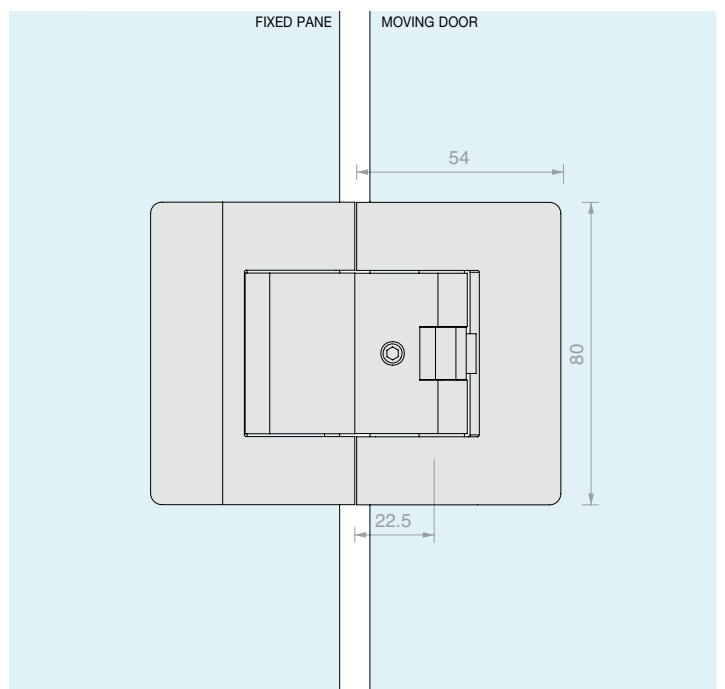
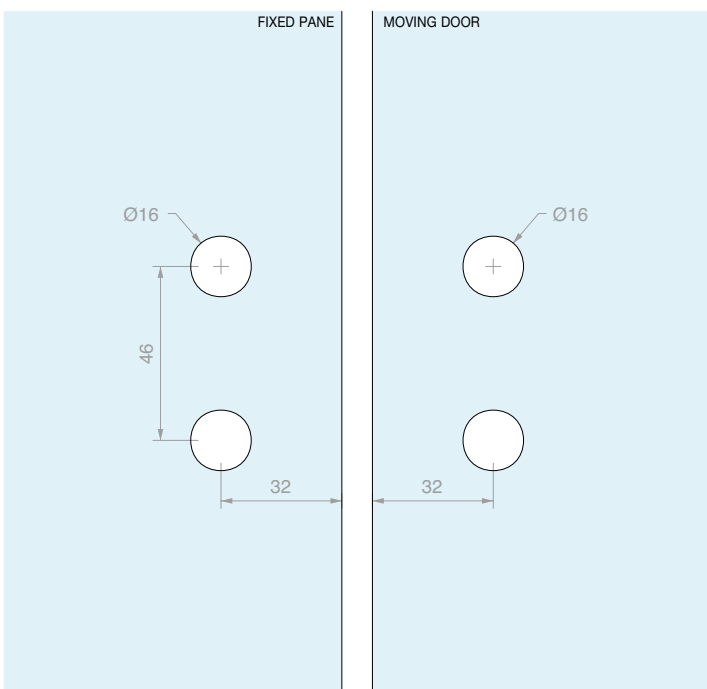
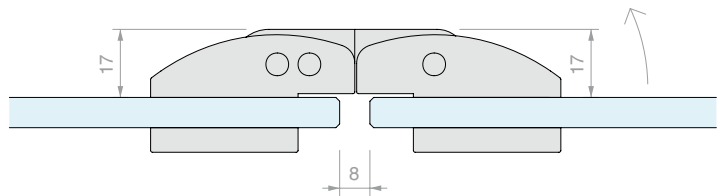

Art.  
**CER720**

For glass  
From 8 to 10 mm

Qty  
1 Pc



**WALL/GLASS ADJUSTABLE SIDE HINGE**

Material: Brass

Finish: /1 /24

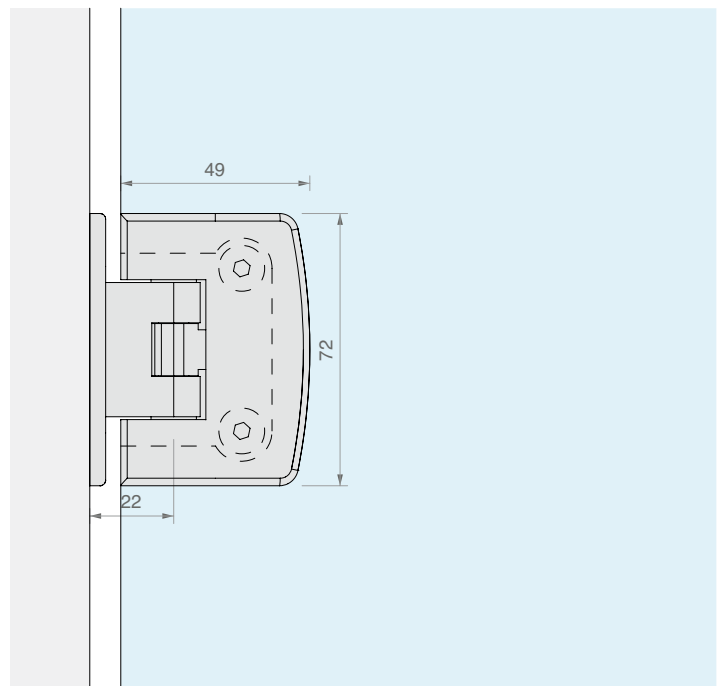
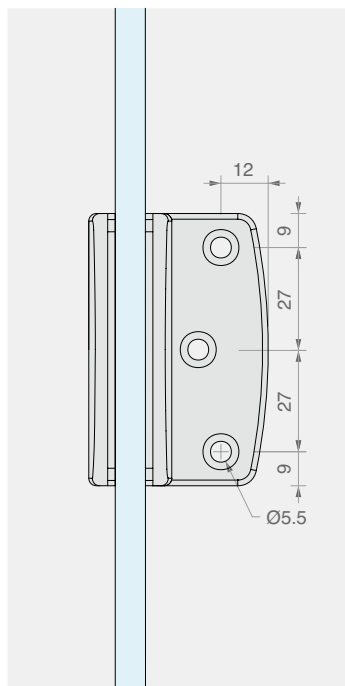
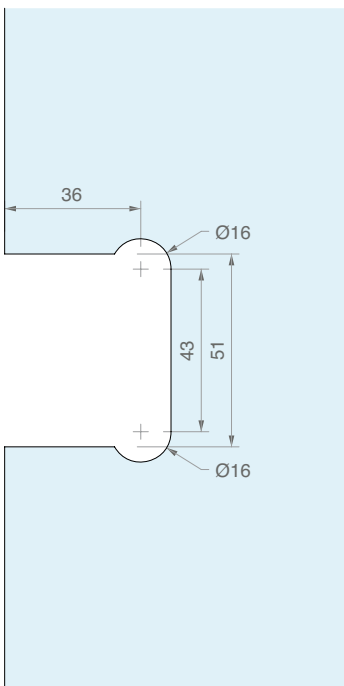
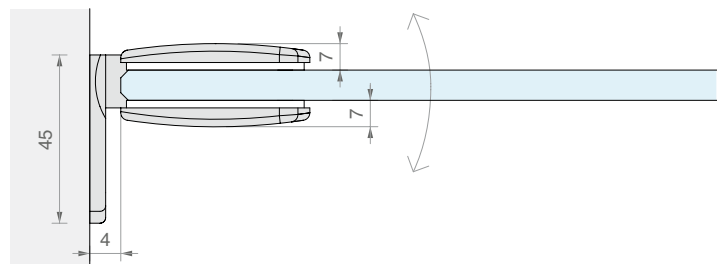
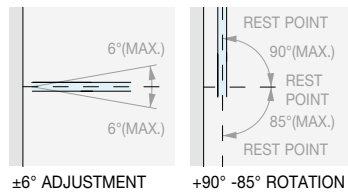

Art. **S150** For glass From 6 to 8 mm

Qty 1 Pc



**WALL/GLASS CENTRAL ADJUSTABLE HINGE**

Material: Brass

Finish: /1 /24

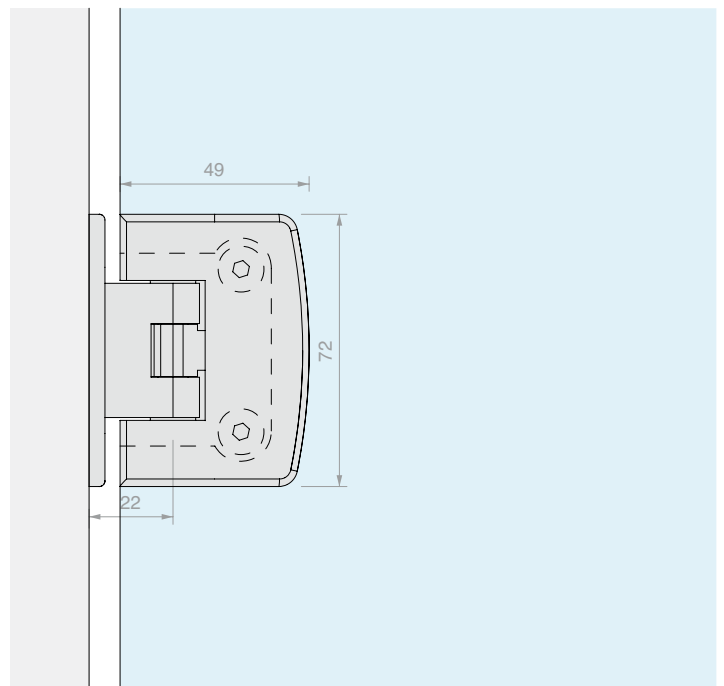
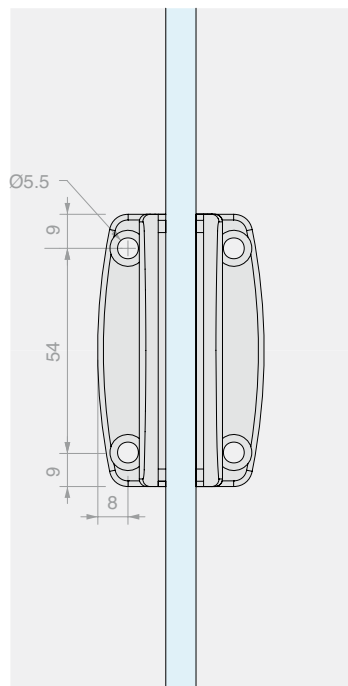
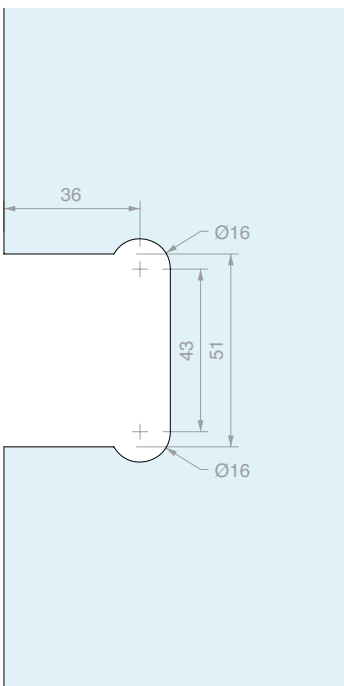
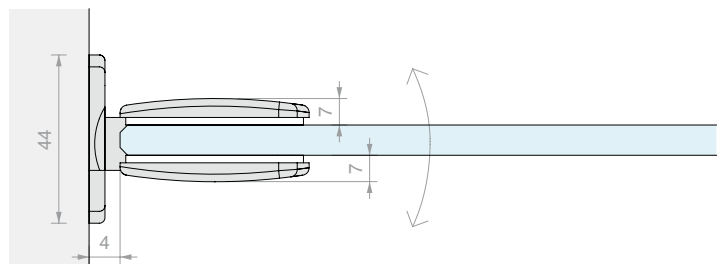
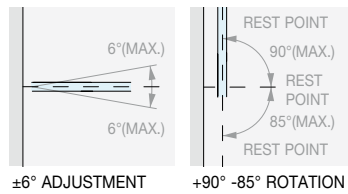

Art. **S153** For glass From 6 to 8 mm

Qty 1 Pc



GLASS/GLASS ADJUSTABLE IN-LINE HINGE

Material: Brass

Finish: /1 /24

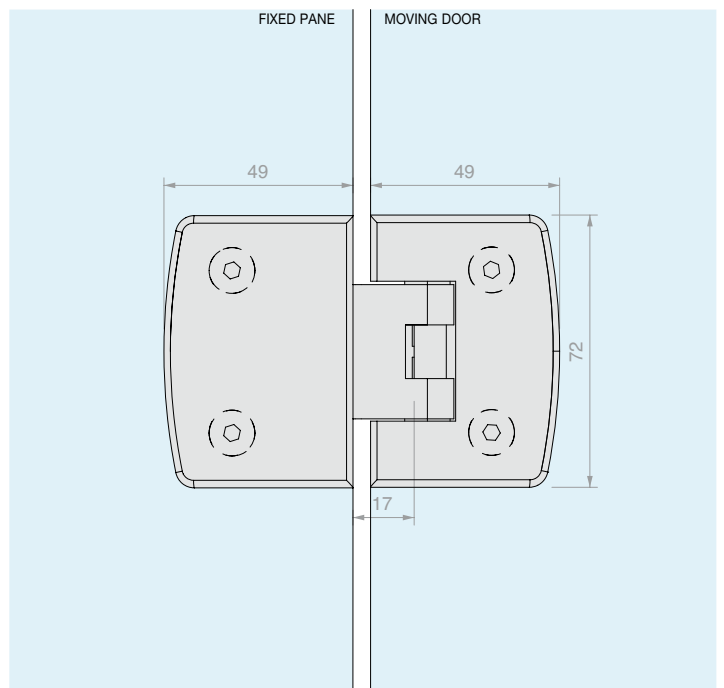
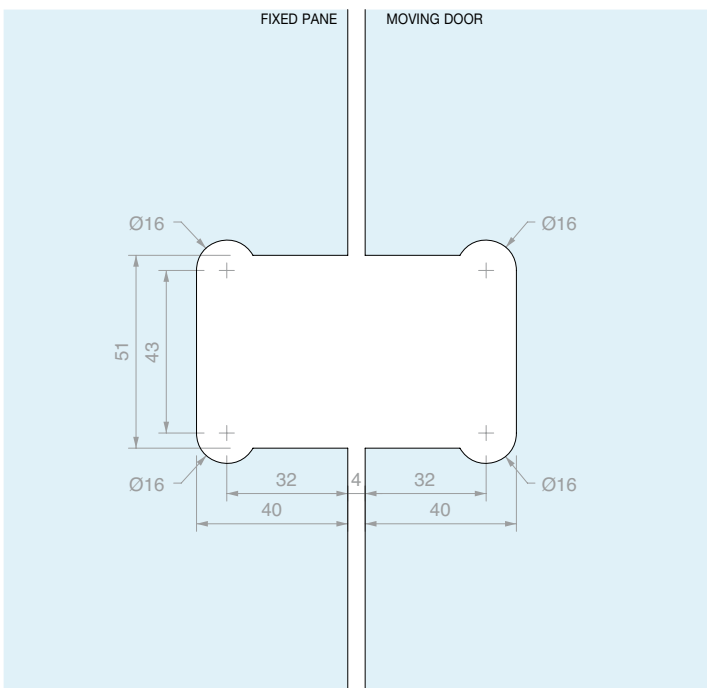
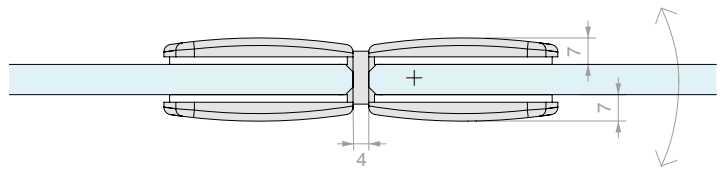
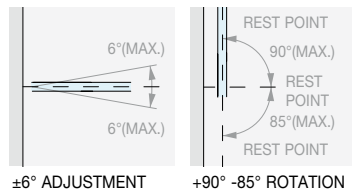

Art.	For glass	Qty
<b>S1180</b>	From 6 to 8 mm	1 Pc





**90° GLASS/GLASS ADJUSTABLE HINGE**

Material: Brass

Finish: /1 /24

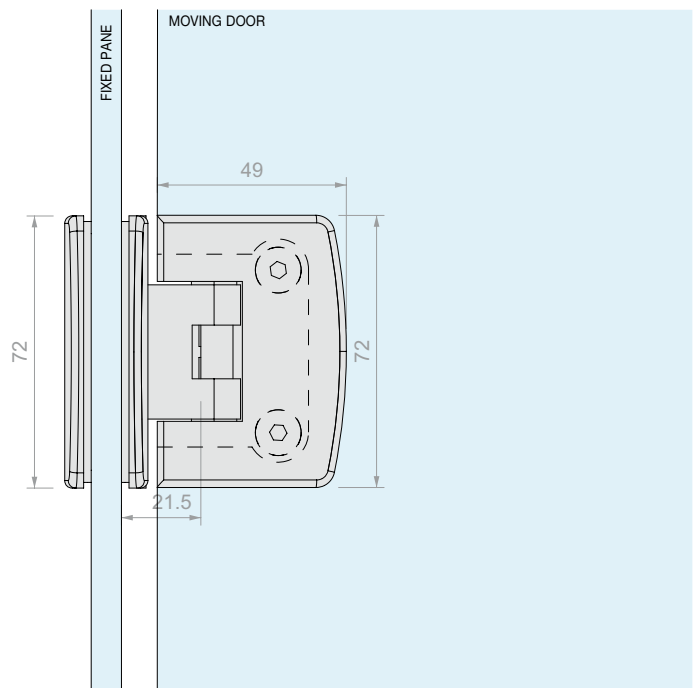
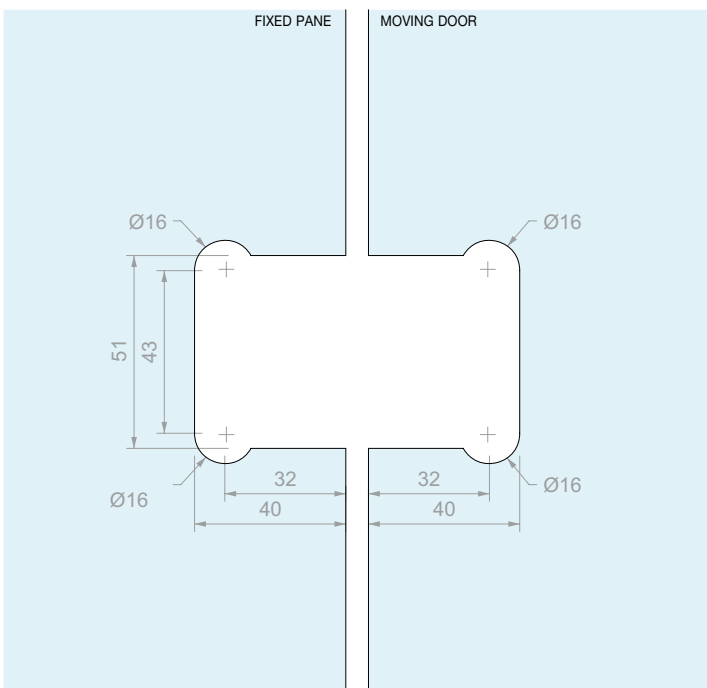
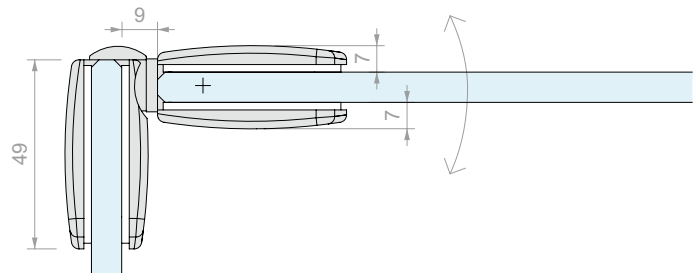
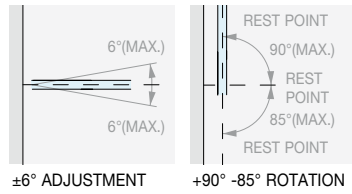

Art. **S190** For glass From 6 to 8 mm

Qty 1 Pc



**WALL/GLASS ADJUSTABLE SIDE HINGE**

Material: Brass

Finish: /1 /24

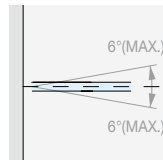
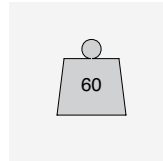
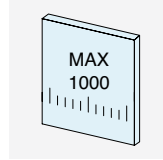
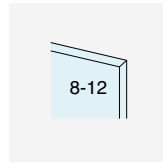

±6° ADJUSTMENT

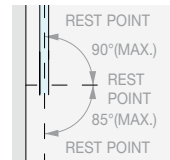

+90° -85° ROTATION

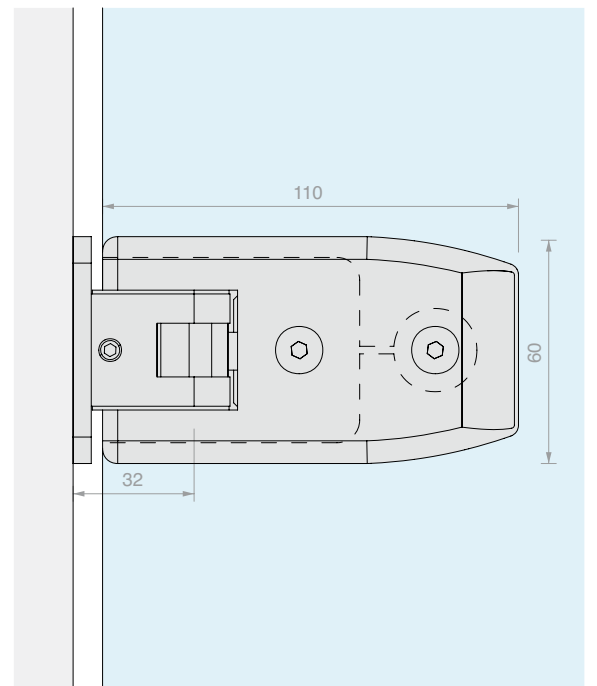
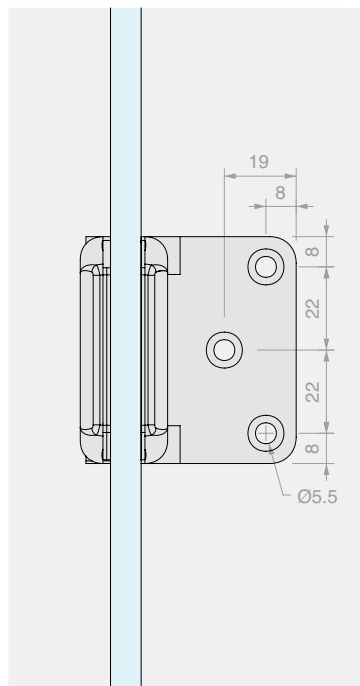
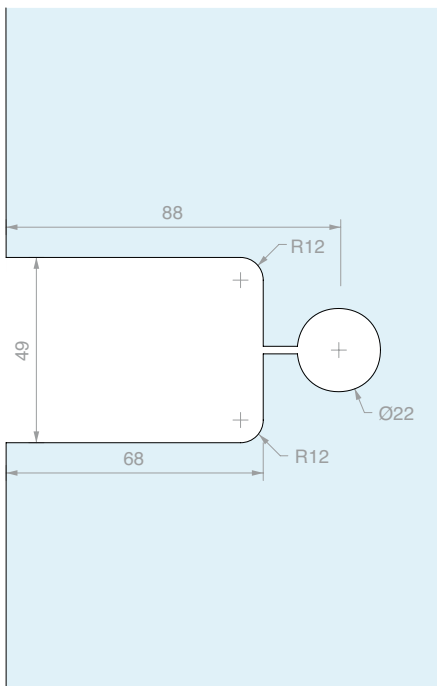
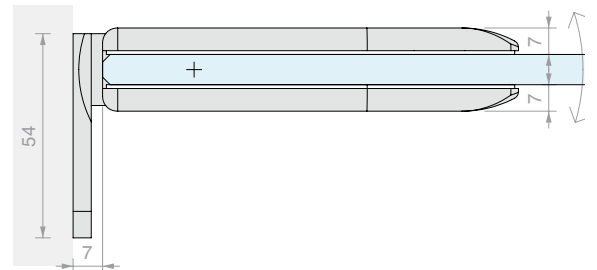

Art. **S600** For glass From 8 to 12 mm

Qty 1 Pc



**WALL/GLASS CENTRAL ADJUSTABLE HINGE**

Material: Brass

Finish: /1 /24

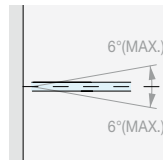
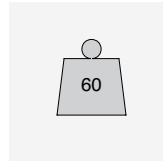
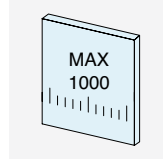
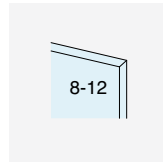

±6° ADJUSTMENT

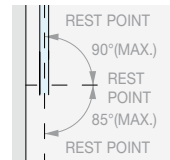

+90° -85° ROTATION

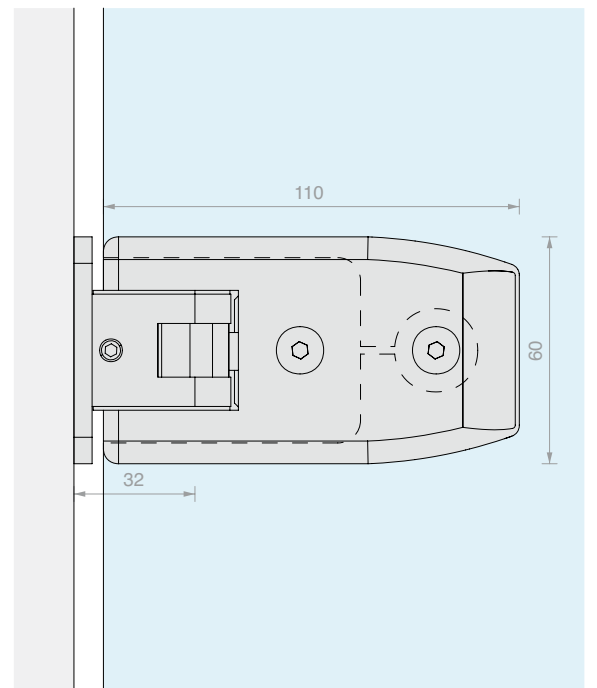
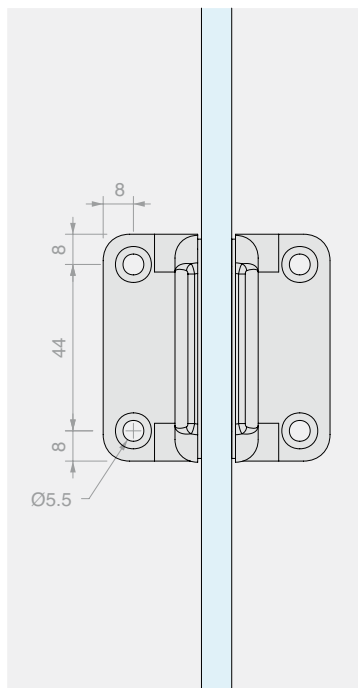
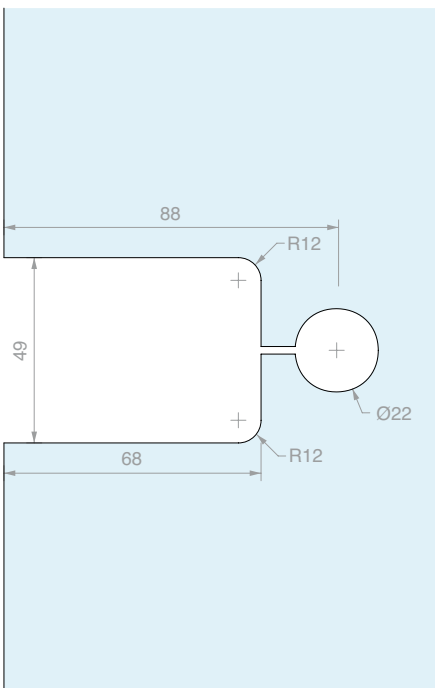
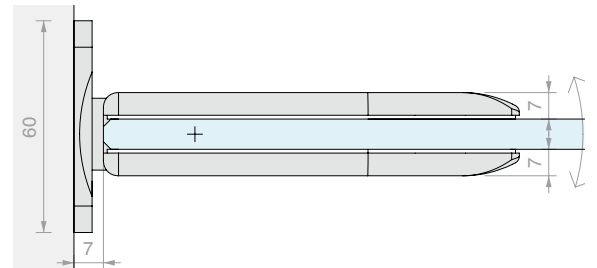

Art. **S603** For glass From 8 to 12 mm

Qty 1 Pc



**WALL/GLASS ADJUSTABLE SIDE HINGE**

Material: Brass

Finish: /1 /24 /R2

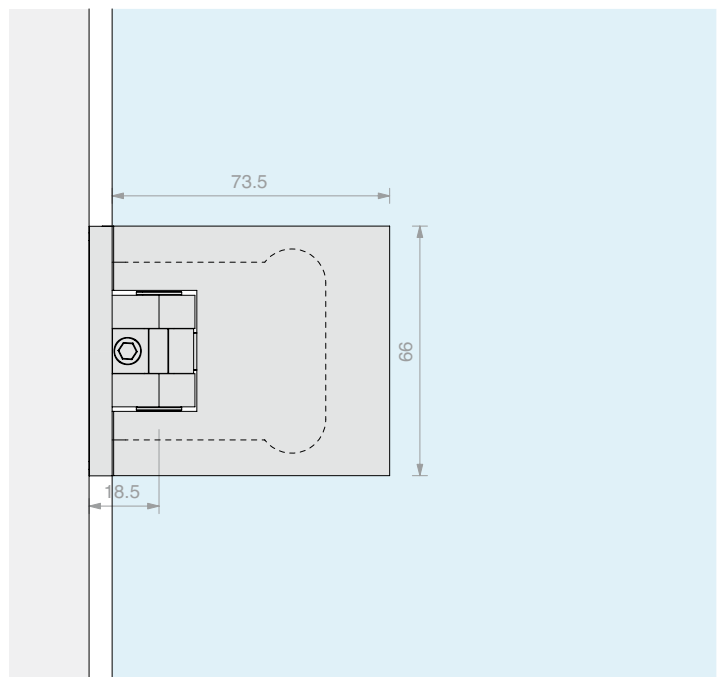
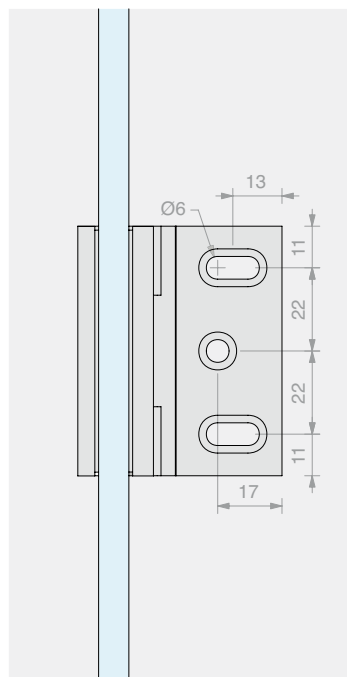
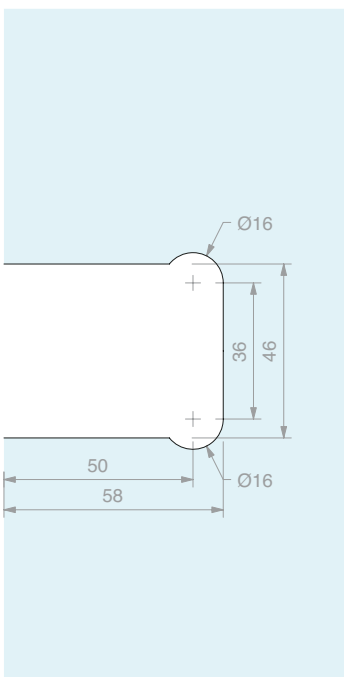
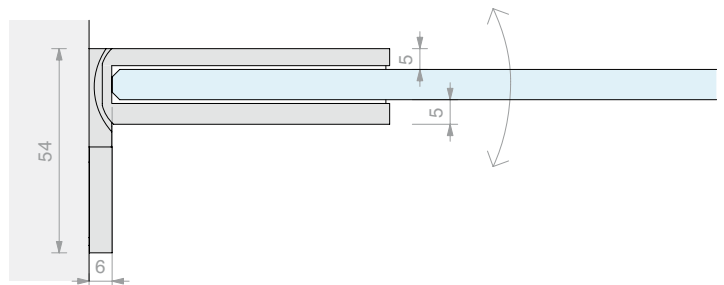

Art. **CER800**

For glass  
From 8 to 12 mm

Qty  
1 Pc



**GLASS/GLASS ADJUSTABLE IN-LINE HINGE**

Material: Brass

Finish: /1 /24 /R2

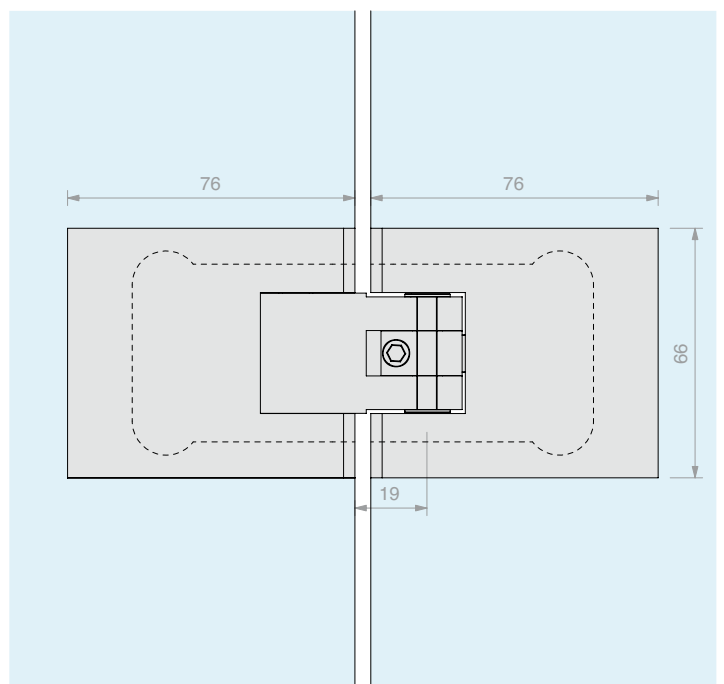
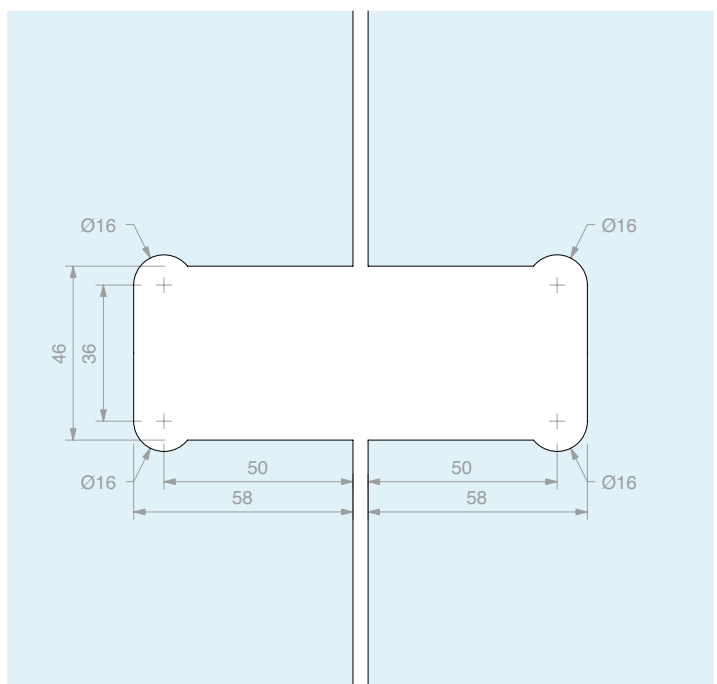
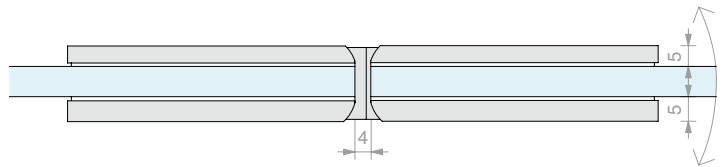

Art.  
**CER880**

For glass  
From 8 to 12 mm

Qty  
1 Pc



**WALL/GLASS SIDE HINGE**

Material: Zamak

Finish: /1 /24 /R2

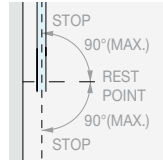
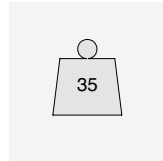
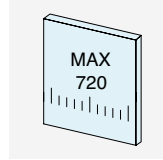
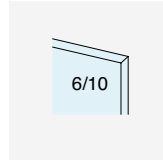

±90° ROTATION

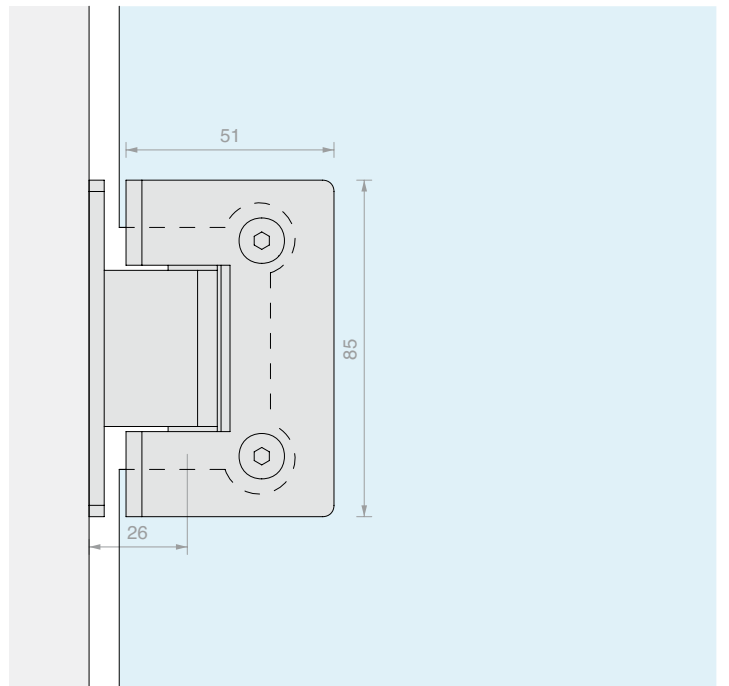
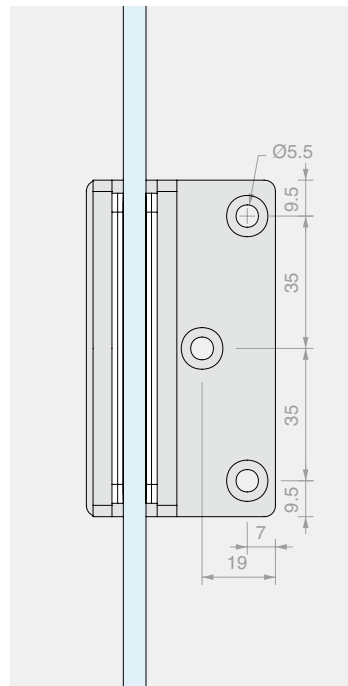
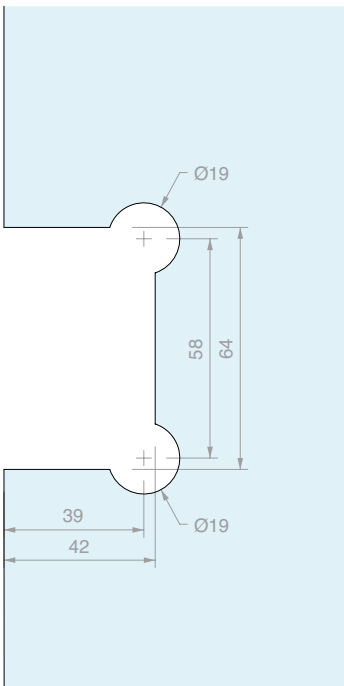
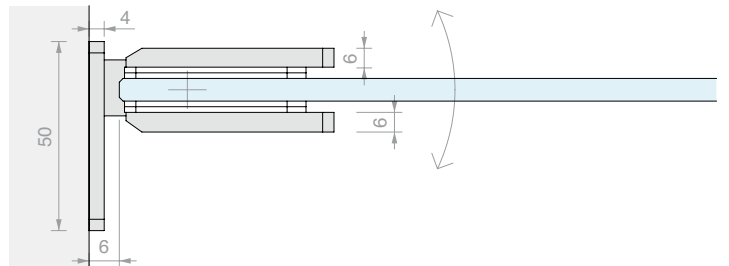

Art.  
**CERZ31**

For glass  
From 6 to 10 mm

Qty  
1 Pc



**WALL/GLASS CENTRAL HINGE**

Material: Zamak

Finish: /1 /24 /R2

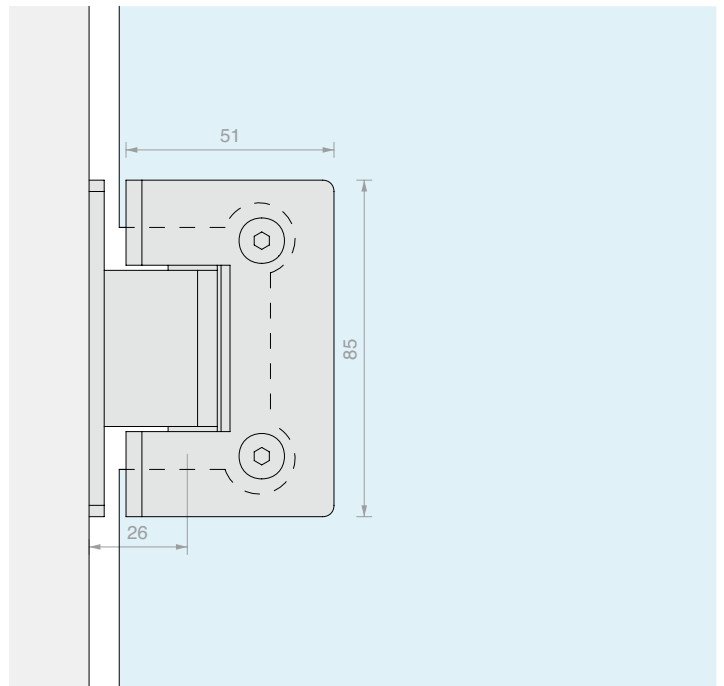
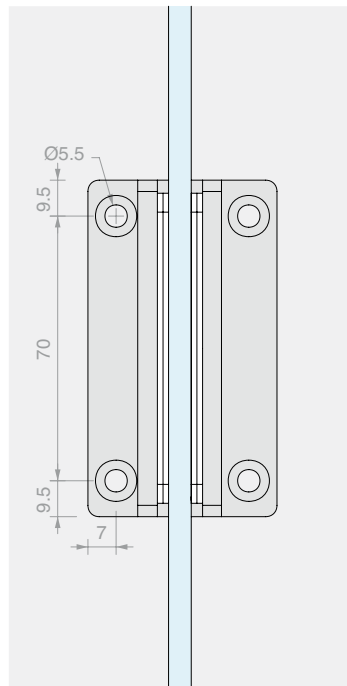
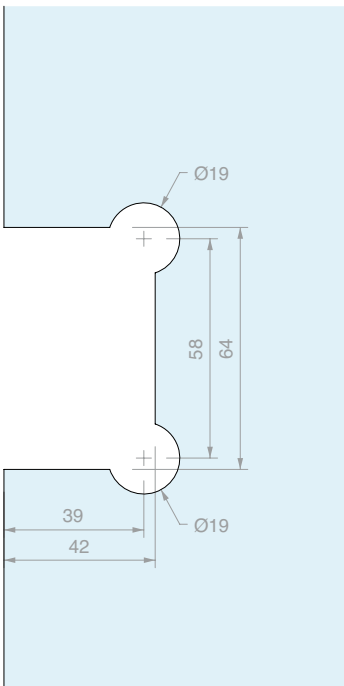
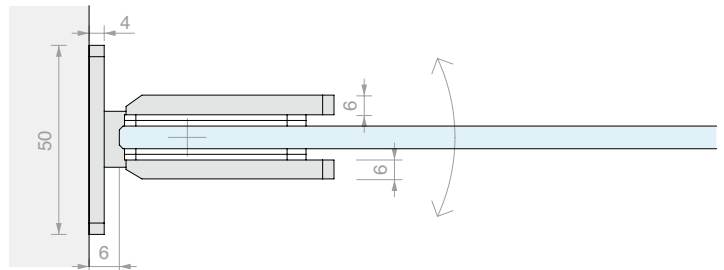

Art.  
**CERZ33**

For glass  
From 6 to 10 mm

Qty  
1 Pc



**GLASS/GLASS IN-LINE HINGE**

Material: Zamak

Finish: /1 /24 /R2

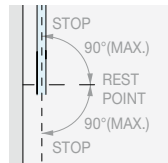

±90° ROTATION

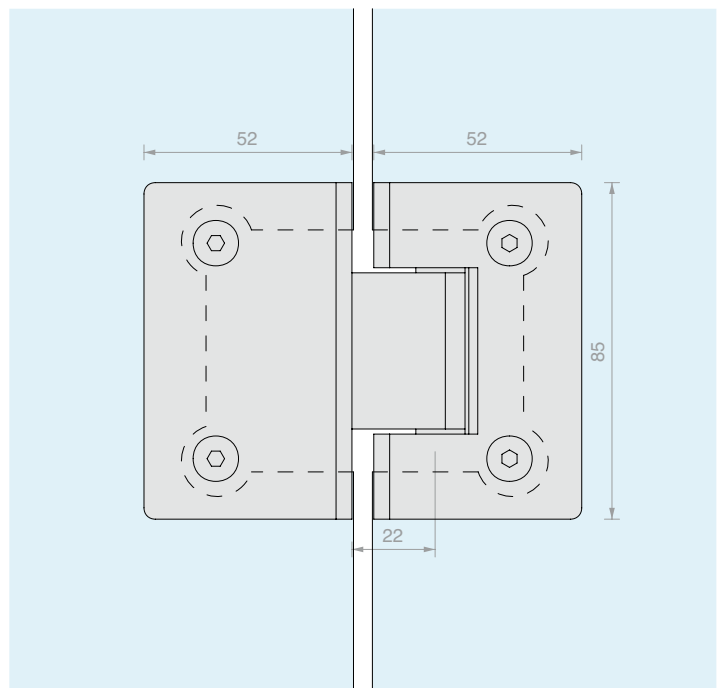
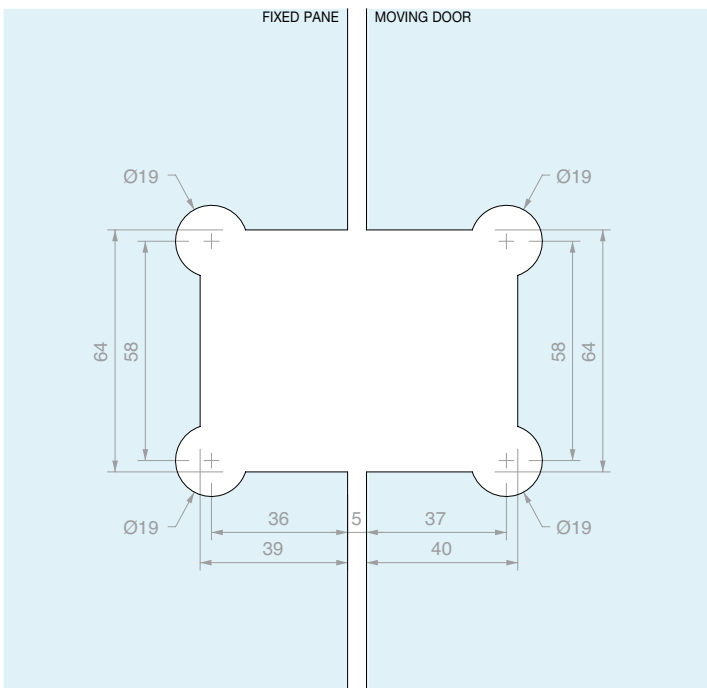
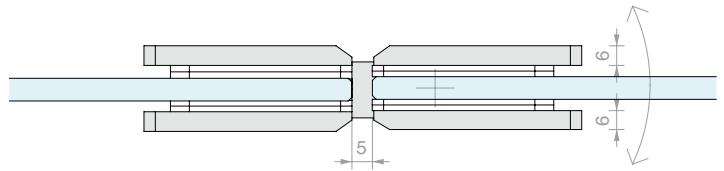

Art. **CERZ3180**

For glass  
From 6 to 10 mm

Qty  
1 Pc







**WALL/GLASS SIDE HINGE**

Material: AISI 304 stainless steel

Finish: /8 /15

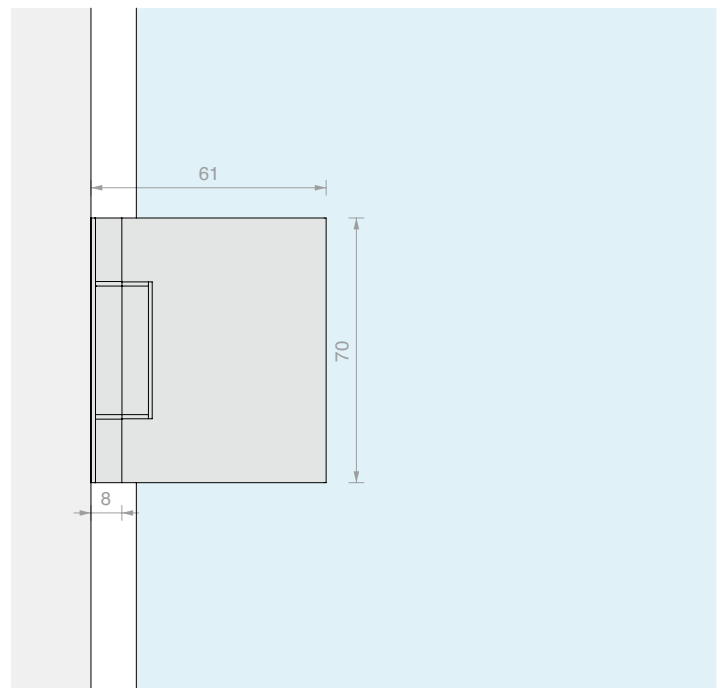
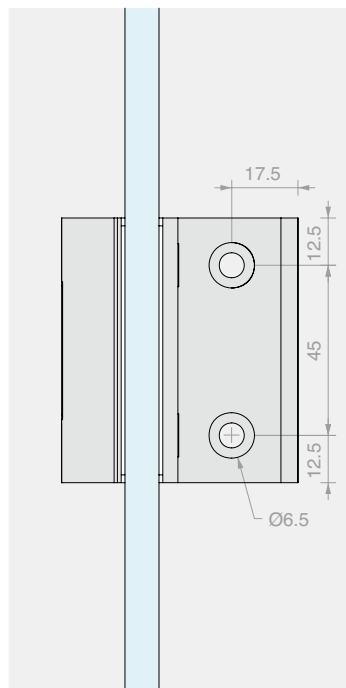
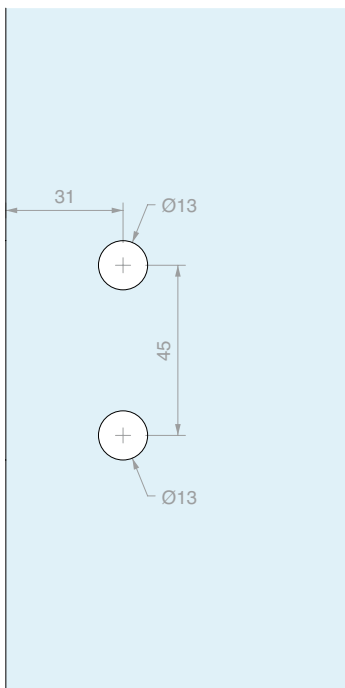
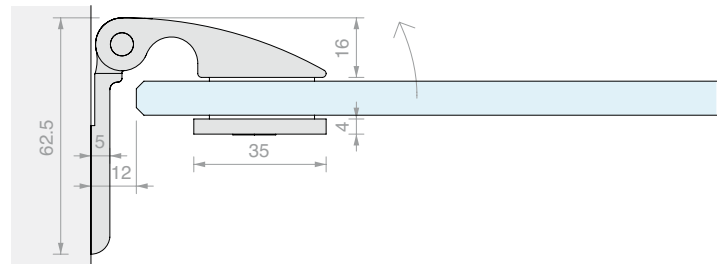

Art.  
**CBD500**

For glass  
From 8 to 10 mm

Qty  
1 Pc



**GLASS/GLASS IN-LINE HINGE**

Material: AISI 304 stainless steel

Finish: /8 /15

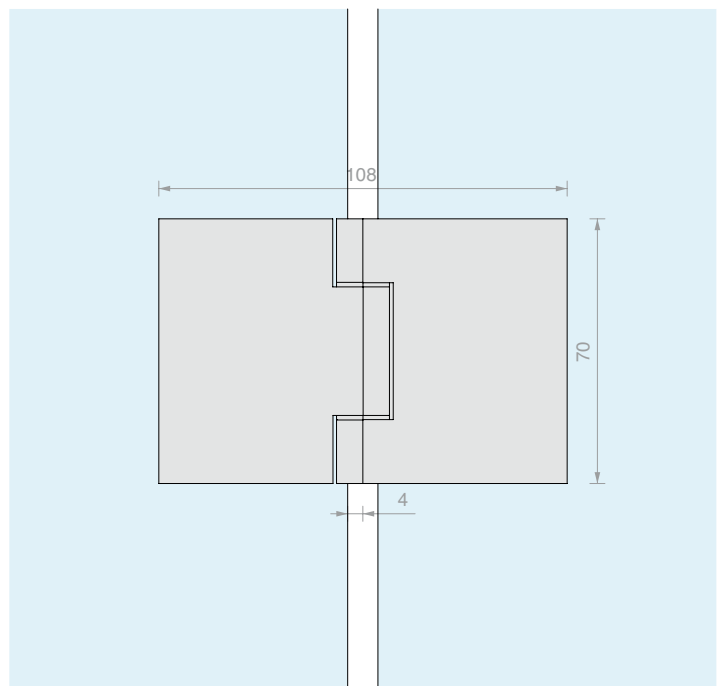
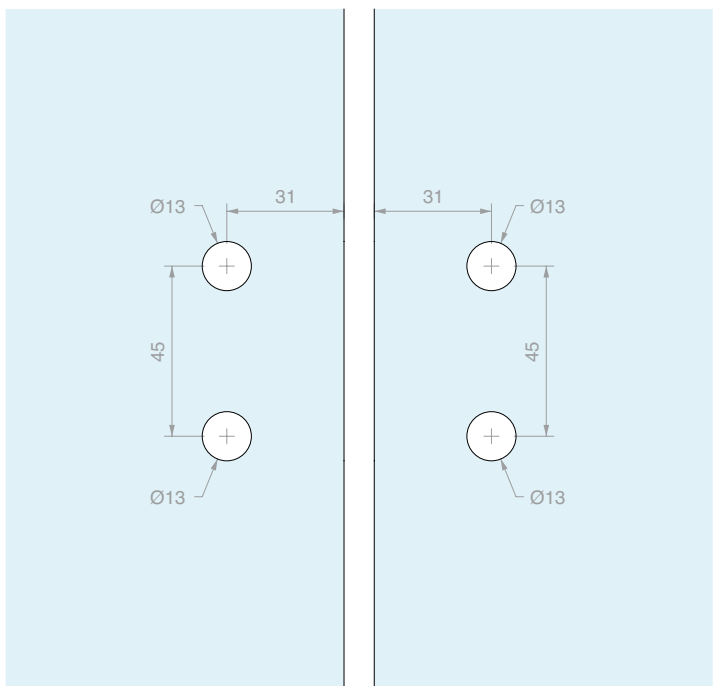
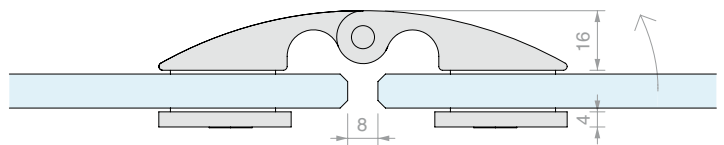

Art.  
**CBD580**

For glass  
From 8 to 10 mm

Qty  
1 Pc



### ADJUSTABLE PIVOT HINGE

Material: Brass

Finish: /1 /3

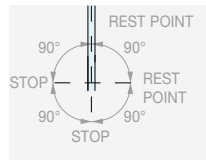
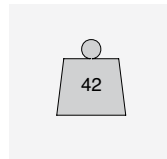
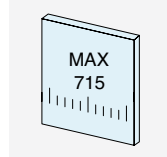
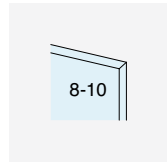

360° ROTATION

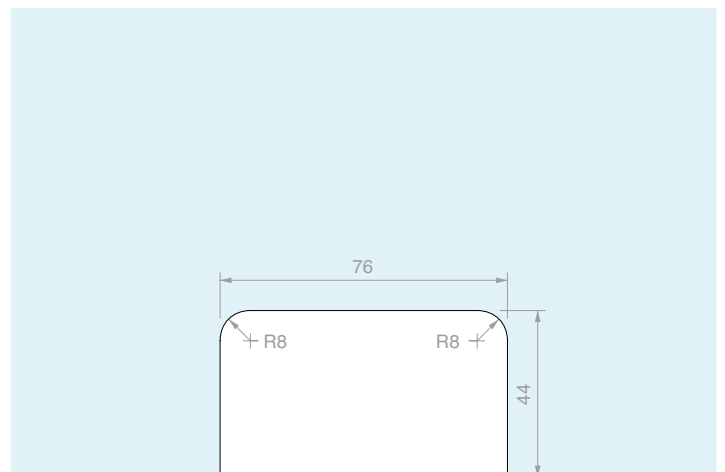
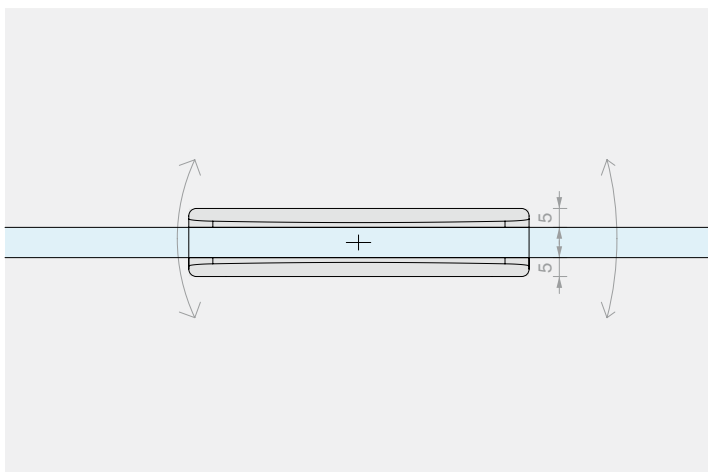
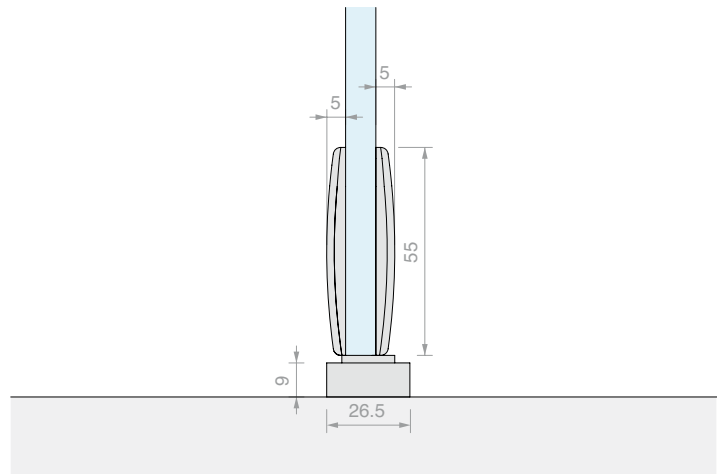
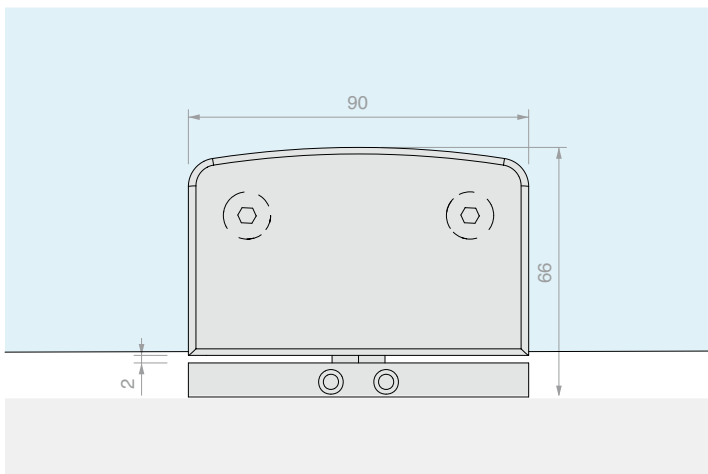

Art. **S4500** For glass From 8 to 10 mm

Qty 1 Pc



**WALL/GLASS HINGE WITH NECK, OUTWARD OPENING**

Material: Brass

Finish: /1 /24

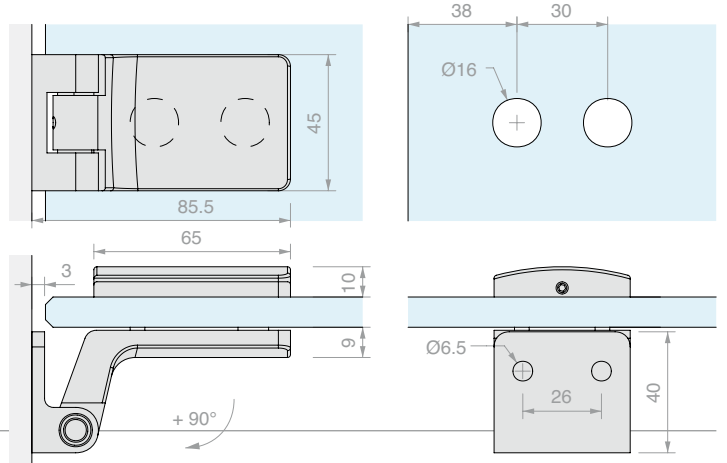

Art.	Max. load	Max. width	For glass	Qty
<b>SFH100</b>	<b>50 kg</b>	<b>815 mm</b>	From <b>8 to 10 mm</b>	<b>1 Pc</b>



**WALL/GLASS OUTWARD OPENING HINGE**

Material: Brass

Finish: /1 /24

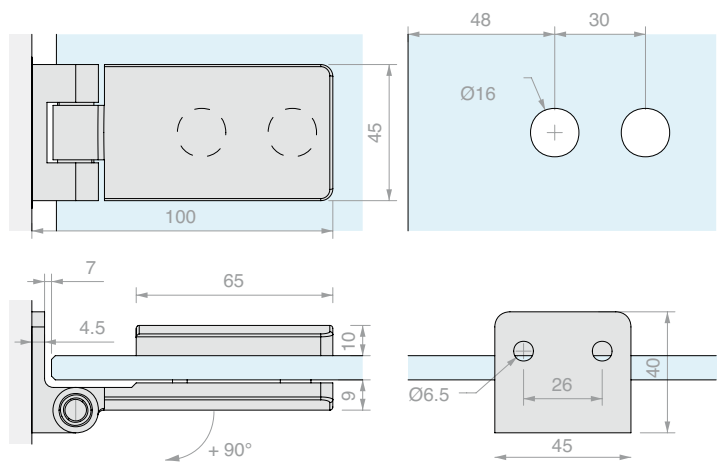

Art.	Max. load	Max. width	For glass	Qty
<b>SFH101</b>	<b>50 kg</b>	<b>815 mm</b>	From <b>8 to 10 mm</b>	<b>1 Pc</b>



**WALL/GLASS INWARD OPENING HINGE**

Material: Brass

Finish: /1 /24

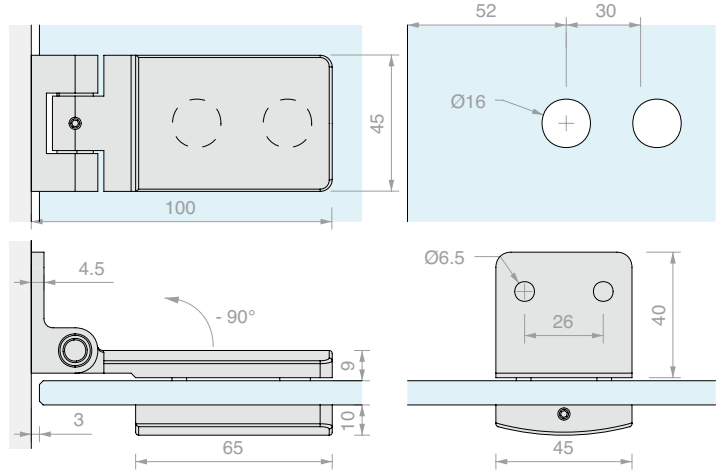

Art.	Max. load	Max. width	For glass	Qty
<b>SFH102</b>	<b>50 kg</b>	<b>815 mm</b>	From <b>8</b> to <b>10</b> mm	<b>1 Pc</b>



**GLASS/GLASS OUTWARD OPENING IN-LINE HINGE**

Material: Brass

Finish: /1 /24

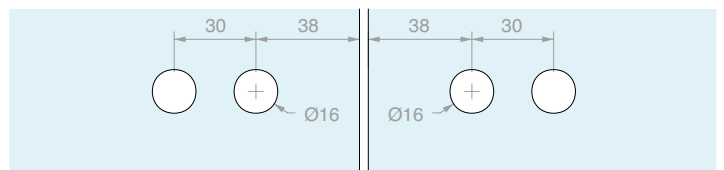
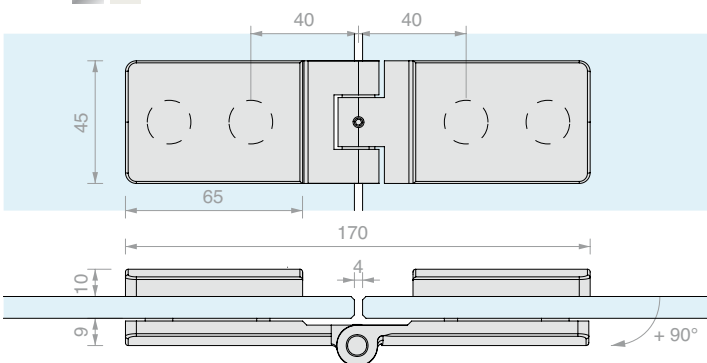

Art.	Max. load	Max. width	For glass	Qty
<b>SFH103</b>	<b>50 kg</b>	<b>815 mm</b>	From <b>8</b> to <b>10</b> mm	<b>1 Pc</b>



**WALL/GLASS OUTWARD OPENING HINGE**

Material: Brass  
 Finish: /1 /2 /24

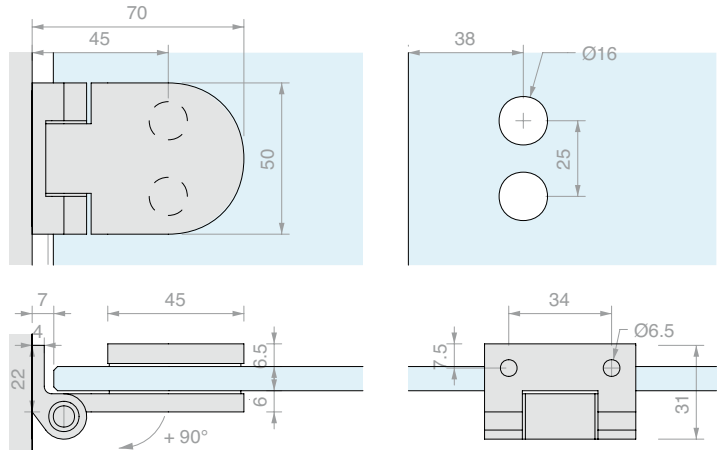

Art.	Max. load	Max. width	For glass	Qty
<b>SFH801</b>	<b>40 kg</b>	<b>715 mm</b>	From 6 to 8 mm	1 Pc



**WALL/GLASS INWARD OPENING HINGE**

Material: Brass  
 Finish: /1 /2 /24

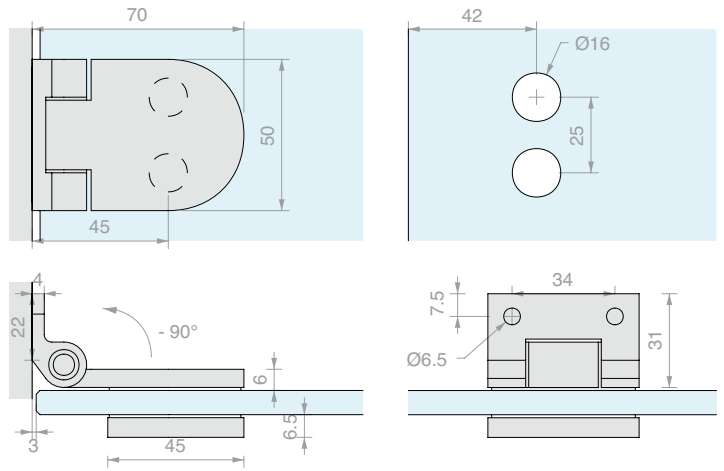

Art.	Max. load	Max. width	For glass	Qty
<b>SFH802</b>	<b>40 kg</b>	<b>715 mm</b>	From 6 to 8 mm	1 Pc



**GLASS/GLASS OUTWARD OPENING IN-LINE HINGE**

Material: Brass  
 Finish: /1 /2 /24

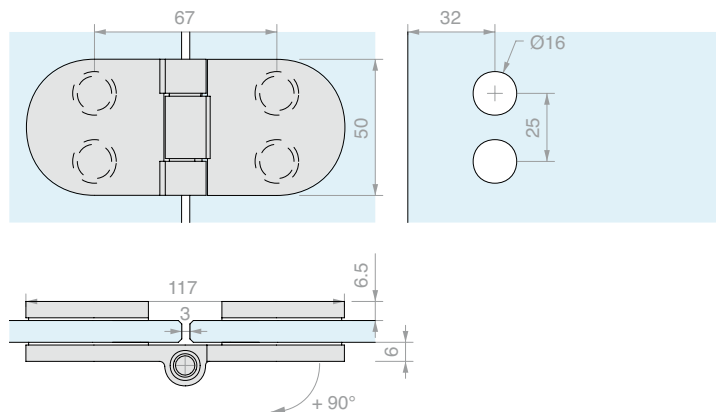

Art.	Max. load	Max. width	For glass	Qty
<b>SFH803</b>	<b>40 kg</b>	<b>715 mm</b>	From 6 to 8 mm	1 Pc



### CLOSURE WITH KEY LOCK

Material: Brass

Finish: /1 /24

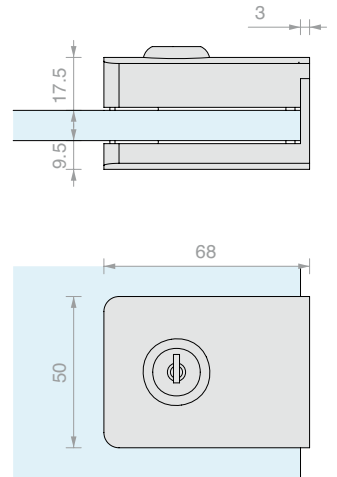
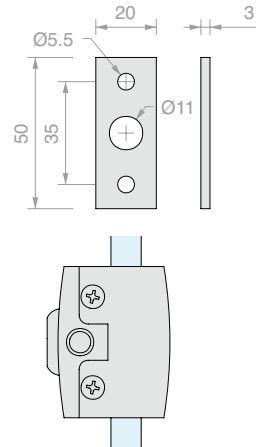

Art.	Pin	Key	For glass	Qty
<b>CLK20</b>	Ø7 L 16 mm	Different	From 8 to 10 mm	1 Pc



### CLOSURE WITH KEY LOCK AND HANDLES

Material: Brass

Finish: /1 /24

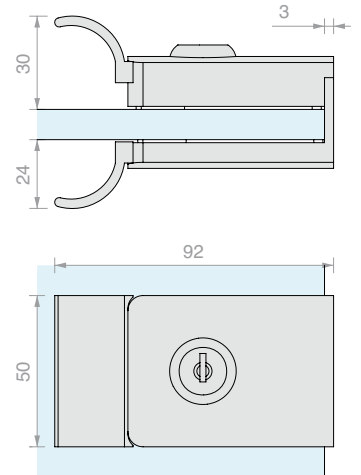
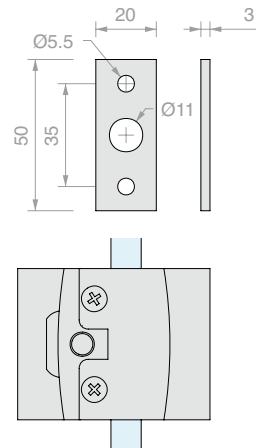

Art.	Pin	Key	For glass	Qty
<b>CLKM27</b>	Ø7 L 16 mm	Different	From 8 to 10 mm	1 Pc



### LOCK WITH KNOB

Material: Brass

Finish: /1 /24

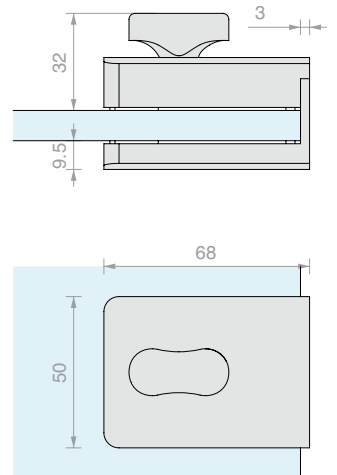
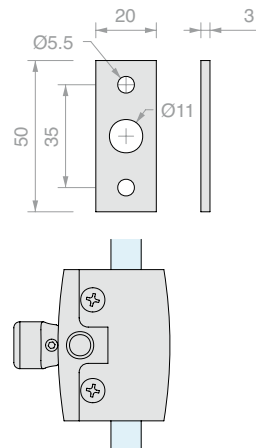

Art.	Pin	For glass	Qty
<b>CLS245</b>	Ø7 L 16 mm	From 8 to 10 mm	1 Pc





**CLOSURE WITH DOOR KNOB AND HANDLES**

Material: Brass

Finish: /1 /24

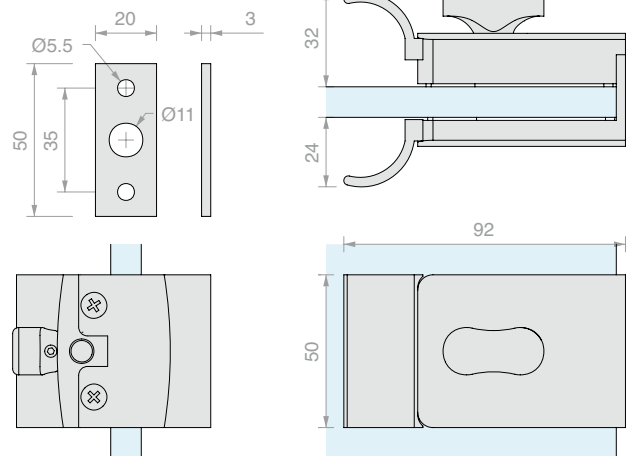

Art.	Pin	For glass	Qty
<b>CPM247</b>	Ø7 L 16 mm	From 8 to 10 mm	1 Pc



**FREE/OCCUPIED LOCK WITH DOOR KNOB**

Material: Brass

Finish: /1 /24

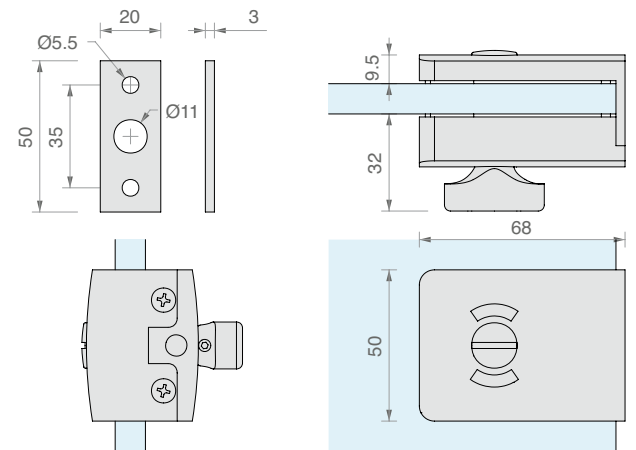

Art.	Pin	For glass	Qty
<b>CLS24</b>	Ø7 L 16 mm	From 8 to 10 mm	1 Pc



**FREE/OCCUPIED CLOSURE WITH DOOR KNOB AND HANDLES**

Material: Brass

Finish: /1 /24

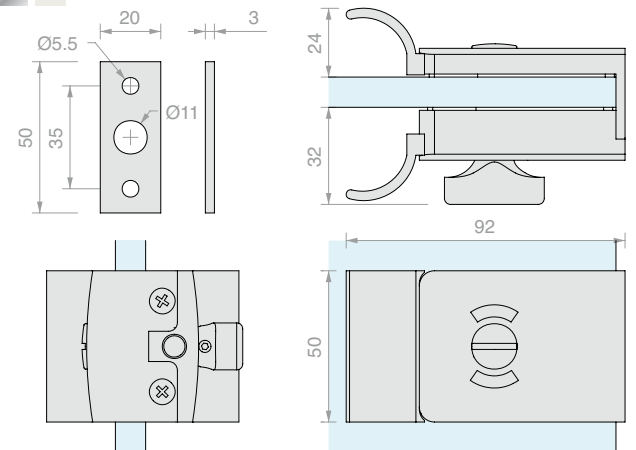

Art.	Pin	For glass	Qty
<b>CLM25</b>	Ø7 L 16 mm	From 8 to 10 mm	1 Pc



**SMALL STRIKE PLATE FOR GLASS**

Material: Brass

Finish: /1 /24

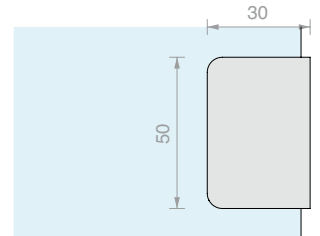
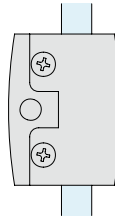
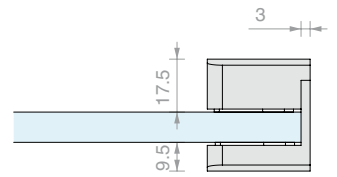

Art.

**CLS70**

For glass

From 8 to 10 mm

Qty

1 Pc



**STRIKE PLATE FOR GLASS**

Material: Brass

Finish: /1 /24

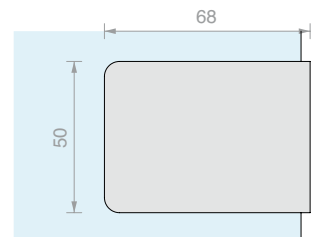
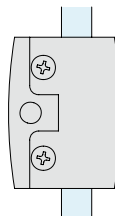
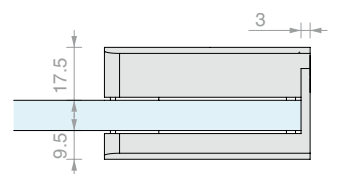

Art.

**CLS68**

For glass

From 8 to 10 mm

Qty

1 Pc



**LATCH FOR SAUNAS**

Material: zamak

Finish: /1 /97

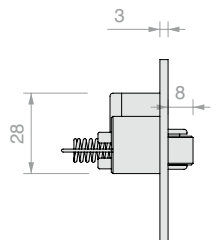
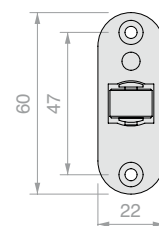
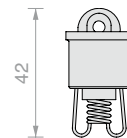

Art.

**SCR001**

Qty

1 Pc



**SOLEIL ROYAL SERIES  
FIXED WALL/GLASS STABILIZER BAR**

Material: AISI 304 steel  
Finish: /8

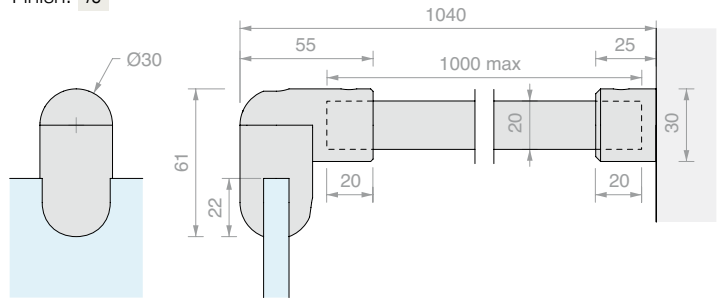

Art.	For glass	Qty
<b>MFAC1000</b>	From 8 to 10 mm	1 Pc

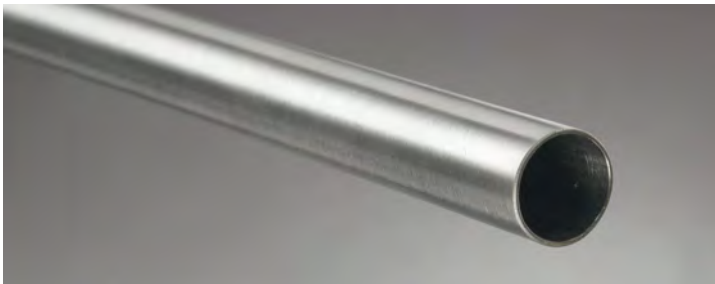

**SOLEIL ROYAL SERIES BAR**

Material: AISI 304 steel  
Finish: /8

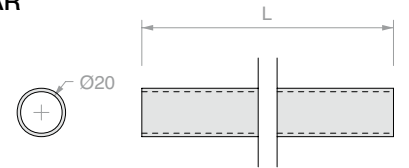

Art.	L	Qty
<b>MFCC20</b>	1000 mm	1 Pc
<b>MFCC28</b>	2000 mm	1 Pc



**SOLEIL ROYAL SERIES  
GLASS FIXING**

Material: AISI 304 steel  
Finish: /8

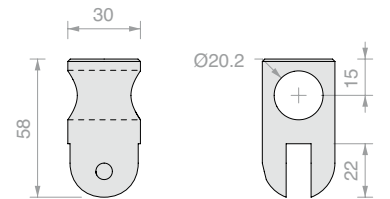

Art.	For glass	Qty
<b>MFCC13</b>	From 8 to 10 mm	1 Pc



**SOLEIL ROYAL SERIES  
ADJUSTABLE  
GLASS FIXING**

Material: AISI 304 steel  
Finish: /8

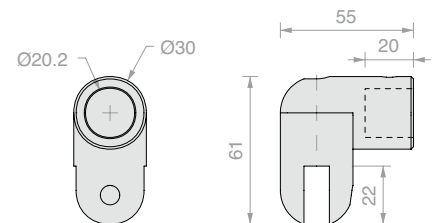

Art.	For glass	Qty
<b>MFCC17</b>	From 8 to 10 mm	1 Pc



**SOLEIL ROYAL SERIES  
WALL FIXING**

Material: AISI 304 steel  
Finish: /8

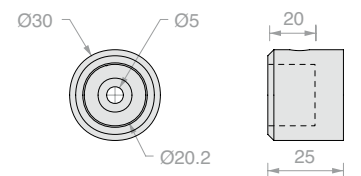

Art.	Qty
<b>MFCC11</b>	1 Pc



**SOLEIL ROYAL SERIES  
ARTICULATED JUNCTION**

Material: AISI 304 steel  
Finish: /8

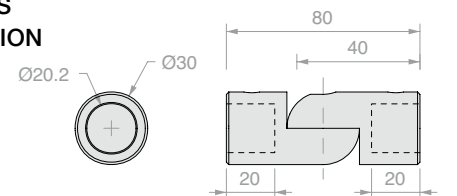

Art.	Qty
<b>MFCC15</b>	1 Pc



**WALL/GLASS STABILIZER BAR WITH DOUBLE JOINT**

Material: aluminium bar, Zamak accessories

Finish: /1

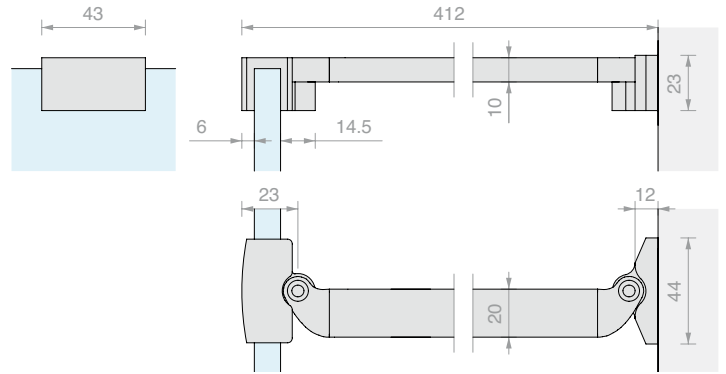

Art.	For glass	Qty
<b>MF350</b>	From 6 to 8 mm	1 Pc



**FIXED WALL/GLASS STABILIZER BAR**

Material: Brass

Finish: /1 /2\* /3 /R2

\* Not available for Art. MF06160

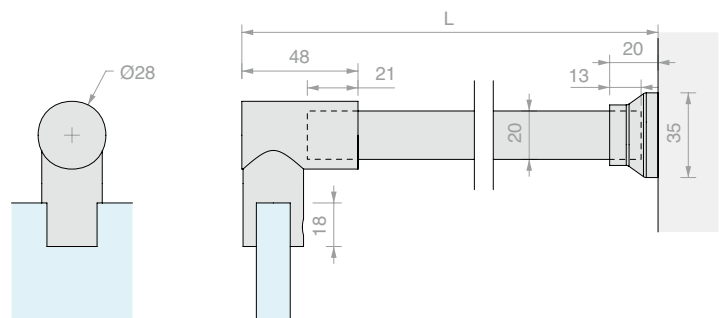

Art.	L	For glass	Qty
<b>MF06100</b>	1020 mm	From 6 to 10 mm	1 Pc
<b>MF06130</b>	1320 mm	From 6 to 10 mm	1 Pc
<b>MF06160</b>	1620 mm	From 6 to 10 mm	1 Pc



**WALL/GLASS STABILIZER BAR WITH WALL JOINT**

Material: Brass

Finish: /1 /3

Art.	For glass	Qty
<b>MF008670</b>	From 6 to 10 mm	1 Pc

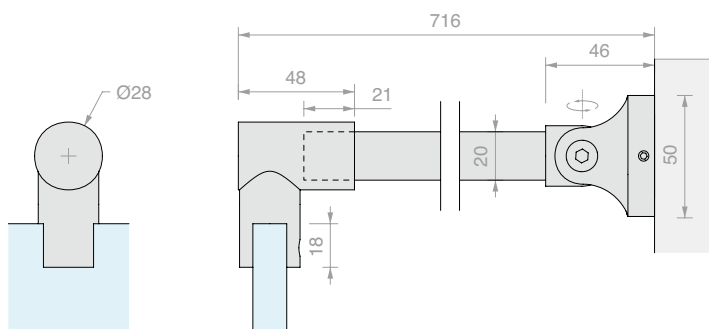

**FIXED GLASS/GLASS STABILIZER BAR**

Material: Brass

Finish: /1 /2\* /3 /R2

\* Not available for Art. MF007160

Art.	L	For glass	Qty
<b>MF007100</b>	1050 mm	From 6 to 10 mm	1 Pc
<b>MF007130</b>	1350 mm	From 6 to 10 mm	1 Pc
<b>MF007160</b>	1650 mm	From 6 to 10 mm	1 Pc

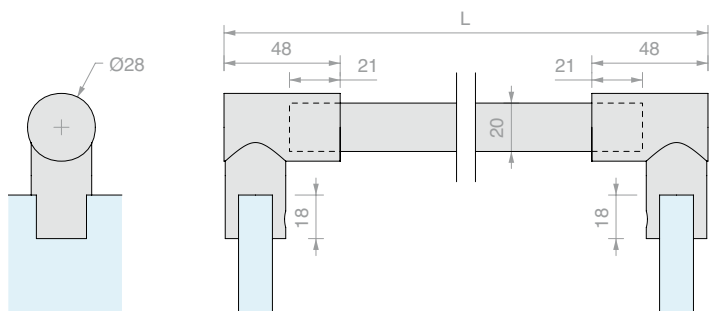

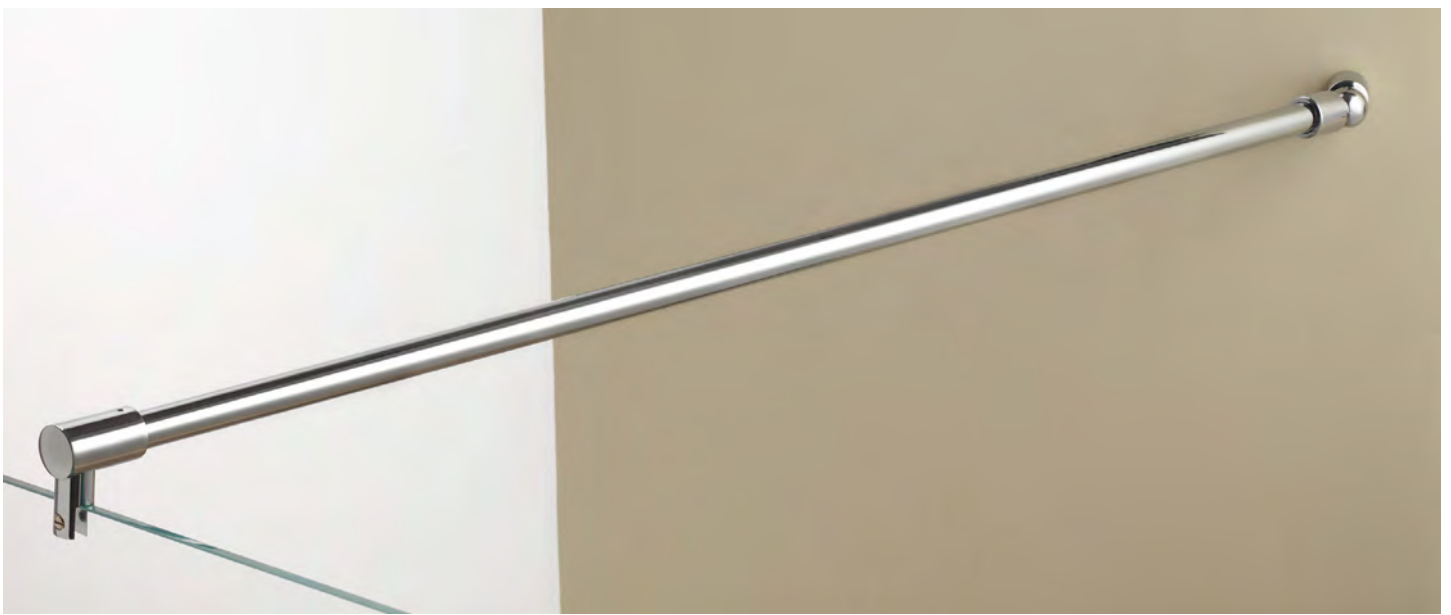

**WALL/GLASS STABILIZER BAR WITH WALL JOINT**

Material: Brass

Finish: /1 /3

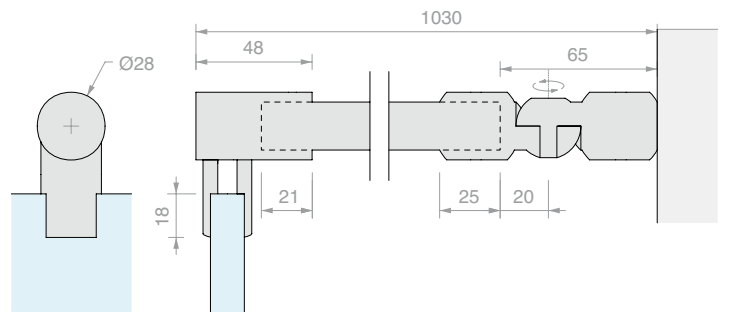

Art.	For glass	Qty
<b>MF9812</b>	From 6 to 10 mm	1 Pc



**TELESCOPIC CEILING/GLASS STABILIZER BAR**

Material: Brass

Finish: /1 /3

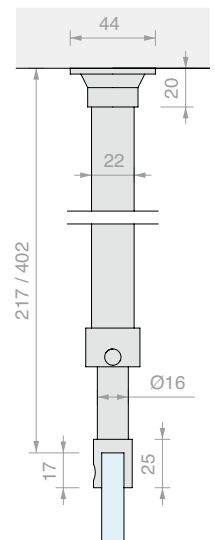

Art.	For glass	Qty
<b>MF09430</b>	From 6 to 10 mm	1 Pc



**FIXED WALL/GLASS STABILIZER BAR WITH FLAT HEAD SCREWS**

Material: Brass  
 Recommended hole size Ø9 mm  
 Finish: /1 /3

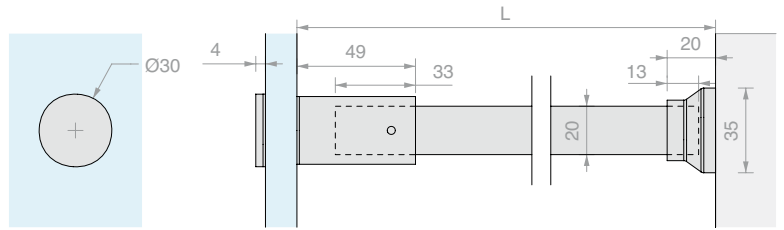

Art.	L	For glass	Qty
<b>MF09410</b>	1020 mm	From 6 to 12 mm	1 Pc
<b>MF09413</b>	1320 mm	From 6 to 12 mm	1 Pc
<b>MF09416</b>	1620 mm	From 6 to 12 mm	1 Pc



**FIXED WALL/GLASS STABILIZER BAR WITH COFIS20**

Material: Brass  
 Recommended hole size Ø16–17 mm, 90° countersink  
 Finish: /1 /3

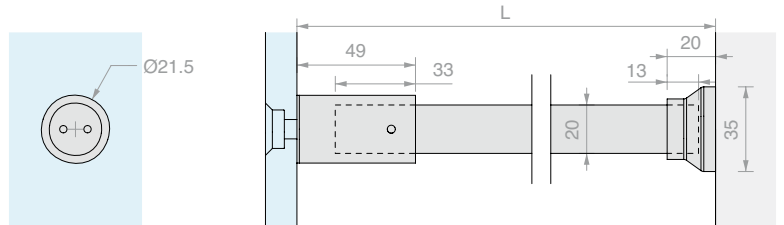

Art.	L	For glass	Qty
<b>MF09410C20</b>	1020 mm	From 8 to 12 mm	1 Pc
<b>MF09413C20</b>	1320 mm	From 8 to 12 mm	1 Pc
<b>MF09416C20</b>	1620 mm	From 8 to 12 mm	1 Pc



**BAR**

Material: Brass  
 With M20x1 threading on one end  
 Finish: /1 /2\* /3 /R2  
 \* Not available for Art. MF1600

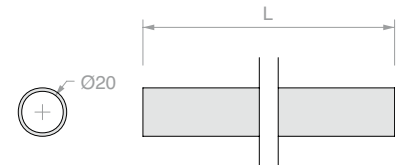

Art.	L	Qty
<b>MF1000</b>	1000 mm	1 Pc
<b>MF1300</b>	1300 mm	1 Pc
<b>MF1600</b>	1600 mm	1 Pc



**GLASS FIXING WITH FLAT HEAD SCREWS**

Material: Brass  
 Recommended hole size Ø9 mm  
 Finish: /1 /3

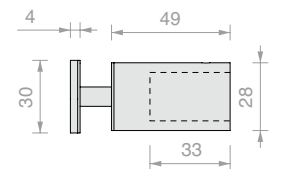

Art.	For glass	Qty
<b>MF12</b>	From 6 to 12 mm	1 Pc



**GLASS FIXING WITH COFIS20**

Material: Brass and AISI 304 steel  
 Recommended hole size Ø16–17 mm, 90° countersink  
 Finish: /1 /3  
 Recommended tool Art. UT250

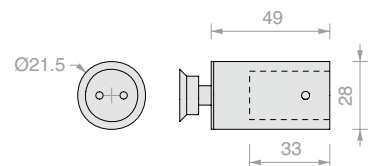

Art.	For glass	Qty
<b>MF10</b>	From 8 to 12 mm	1 Pc

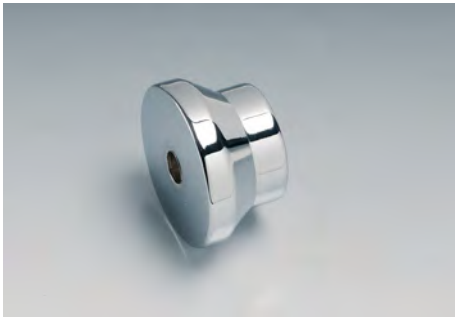

**WALL FIXING**

Material: Brass

Finish: /1 /2 /3 /R2

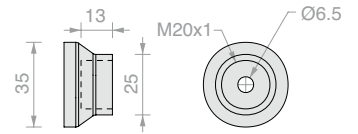

Art.	Qty
<b>MF02</b>	1 Pc



**ADJUSTABLE GLASS FIXING**

Material: Brass

Finish: /1 /2 /3 /R2

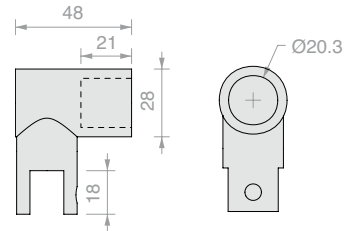

Art.	For glass	Qty
<b>MF04</b>	From 6 to 10 mm	1 Pc



**T-SHAPED CONNECTOR**

Material: Brass

Finish: /1 /3

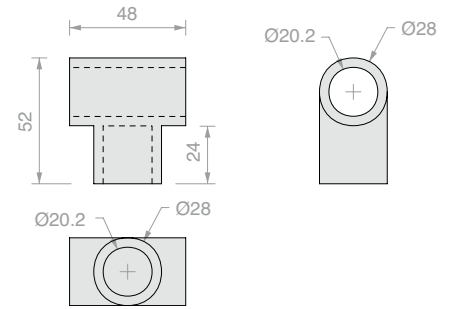

Art.	Qty
<b>MF05</b>	1 Pc



**THROUGH GLASS FIXING**

Material: Brass

Finish: /1 /3

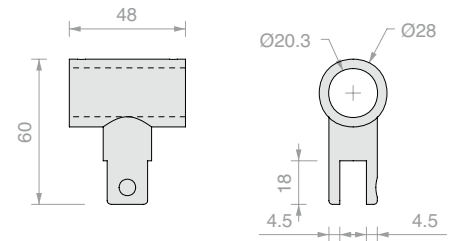

Art.	For glass	Qty
<b>MF06</b>	From 6 to 10 mm	1 Pc



**ARTICULATED JUNCTION**

Material: Brass

Finish: /1 /3

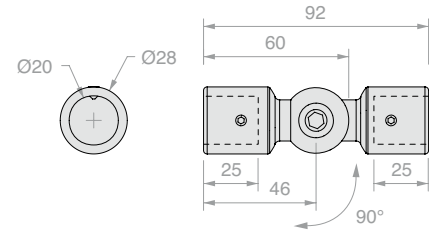

Art.	Qty
<b>SAS020</b>	1 Pc



**SUPPORT FOR WALL ANCHORING FOR SAS020**

Material: Brass

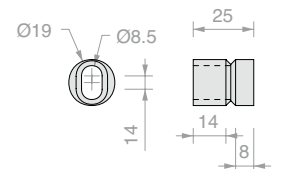

Art.	Qty
<b>MFBOC</b>	1 Pc





**TELESCOPIC WALL/GLASS STABILIZER BAR**

Material: AISI 304 steel and brass

Finish: /1 /15\*

\* only for Art. MF600H

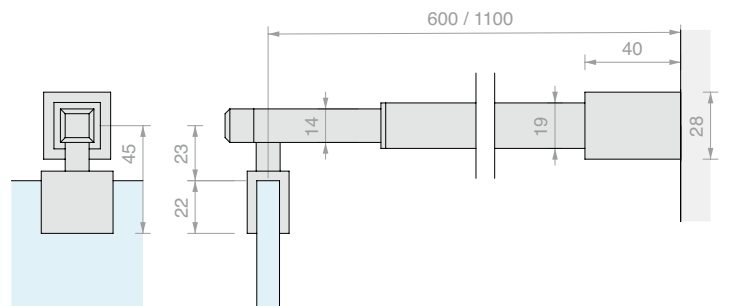

Art.	For glass	Qty
<b>MF600A</b>	From 6 to 8 mm	1 Pc
<b>MF600B</b>	From 10 to 12 mm	1 Pc
<b>MF600H</b>	Only bar	1 Pc

**45° TELESCOPIC WALL/GLASS STABILIZER BAR**

Material: AISI 304 steel and brass

Finish: /1

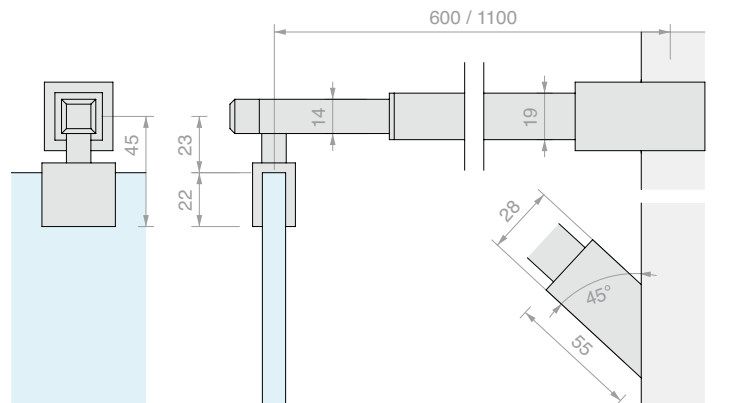

Art.	For glass	Qty
<b>MF645A</b>	From 6 to 8 mm	1 Pc
<b>MF645B</b>	From 10 to 12 mm	1 Pc

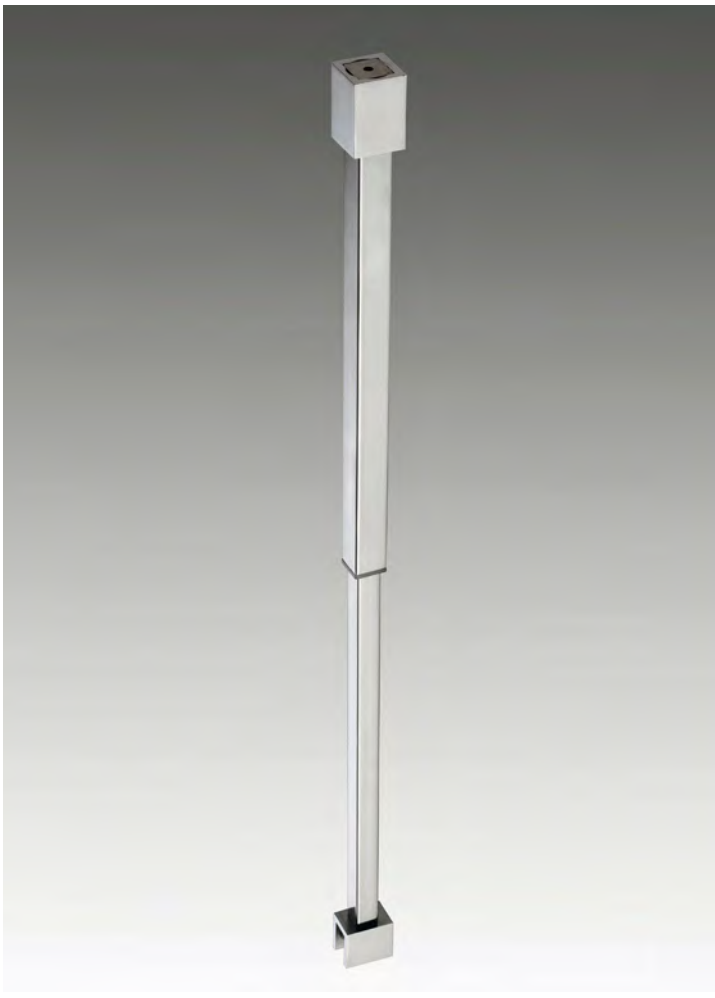

**TELESCOPIC CEILING/GLASS STABILIZER BAR**

Material: AISI 304 steel and brass

Finish: /1 /15\*

\* only for Art. MF300V

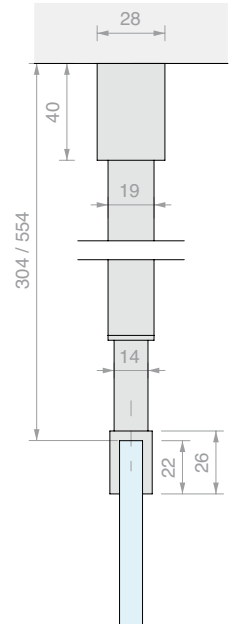

Art.	For glass	Qty
<b>MF300A</b>	From 6 to 8 mm	1 Pc
<b>MF300B</b>	From 10 to 12 mm	1 Pc
<b>MF300V</b>	Only bar	1 Pc



**WALL FIXING**

Material: Brass

Finish: /1

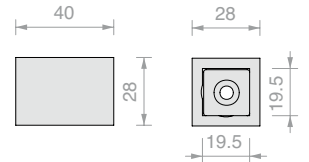

Art.	Qty
<b>MF2890</b>	1 Pc



**45° WALL FIXING**

Material: Brass

Finish: /1

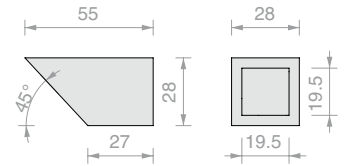

Art.	Qty
<b>MF2845</b>	1 Pc



**U-SHAPED CLAMP WITH NECK**

Material: Brass

Finish: /1

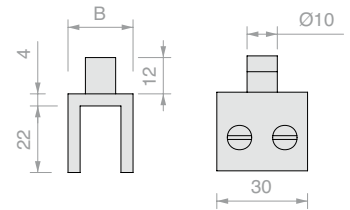

Art.	B	For glass	Qty
<b>MU30095N</b>	17.5 mm	From 6 to 8 mm	1 Pc
<b>MU30135N</b>	21.5 mm	From 10 to 12 mm	1 Pc



**U-SHAPED CLAMP**

Material: Brass

Finish: /1

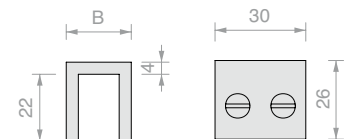

Art.	B	For glass	Qty
<b>MU30095</b>	17.5 mm	From 6 to 8 mm	1 Pc
<b>MU30135</b>	21.5 mm	From 10 to 12 mm	1 Pc



**SQUARED BAR**

Material: Aluminium

Finish: /6 /88 /91

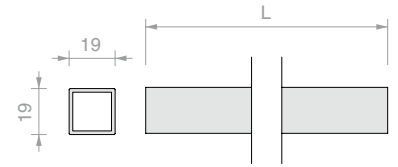

Art.	L	Qty
<b>SPD071000</b>	1000 mm	1 Pc
<b>SPD072000</b>	2000 mm	1 Pc



**ADJUSTABLE GLASS FIXING**

Material: Zamak

Finish: /1 /24 /R2

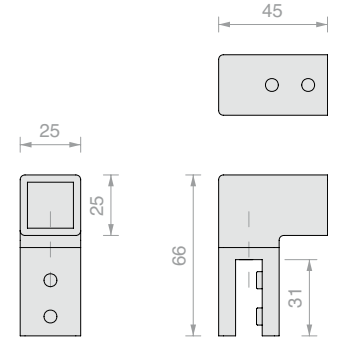

Art.	For glass	Qty
<b>SPD03</b>	From 6 to 10 mm	1 Pc



**WALL FIXING**

Material: Zamak

Finish: /1 /24 /R2

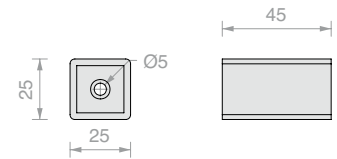

Art.	Qty
<b>SPD05</b>	1 Pc



**TOW-WAY ARTICULATED GLASS FIXING**

Material: Zamak

Finish: /1 /24 /R2

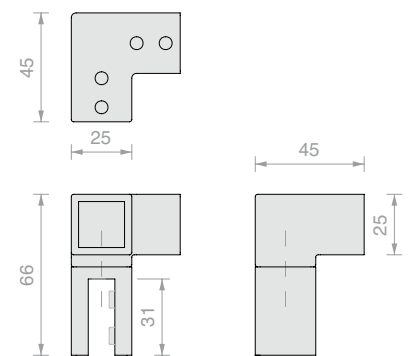

Art.	For glass	Qty
<b>SPD01</b>	From 6 to 10 mm	1 Pc



**ARTICULATED DISTANCED GLASS FIXING**



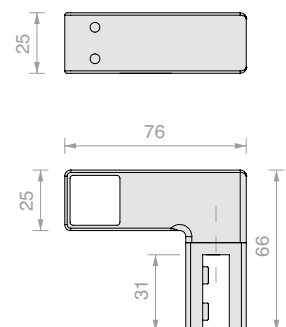

Material: Zamak

Finish: /1 /24 /R2





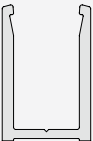
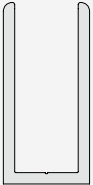

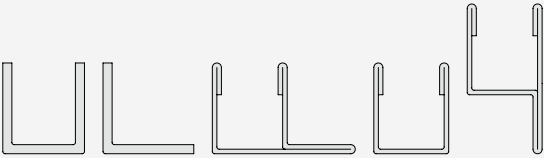
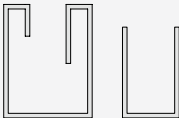
Art.	For glass	Qty
<b>SPD09</b>	From 6 to 10 mm	1 Pc



SUMMARY OF INSTALLATION OPTIONS	Series	Material	Glass fixing
	PBD	Aluminium	Gasket
	LMU	Aluminium	Gasket
	PROALUX	Aluminium	Gasket
	PROFALL	Aluminium	Adhesive
	FORME	Aluminium	Adhesive
	LMUB	Brass	Gasket
	CANAL	AISI 304 Steel	Adhesive
	CMIRR	AISI 304 Steel	Adhesive



 6	 8	 10	 12	 15
<p><b>PBD3183.150</b> Page 406  <b>PBD3183.220</b> Page 406  <b>PBD3183</b> Page 406  <b>PBD3183KR</b> Page 411</p>	<p><b>PBD3183.150</b> Page 406  <b>PBD3183.220</b> Page 406  <b>PBD3183</b> Page 406  <b>PBD3183KR</b> Page 411</p>	<p><b>PBD3183.150</b> Page 406  <b>PBD3183.220</b> Page 406  <b>PBD3183</b> Page 406  <b>PBD3183KR</b> Page 411</p>		
<p><b>LMU20.300</b> Page 406  <b>LMU20.150</b> Page 406</p>	<p><b>LMU20.300</b> Page 406  <b>LMU20.150</b> Page 406</p>	<p><b>LMU20.300</b> Page 406  <b>LMU20.150</b> Page 406</p>		
	<p><b>PROALUX1520</b> Page 408  <b>PROALUX1530</b> Page 408</p>	<p><b>PROALUX1720</b> Page 408  <b>PROALUX1730</b> Page 408</p>	<p><b>PROALUX1920</b> Page 408  <b>PROALUX1930</b> Page 408</p>	
<p><b>PROFALL0820</b> Page 409  <b>PROFALL0820KR</b> Page 411</p>	<p><b>PROFALL0820</b> Page 409  <b>PROFALL0820KR</b> Page 411</p>	<p><b>PROFALL1020</b> Page 409  <b>PROFALL1225</b> Page 409  <b>PROFALL1240</b> Page 409  <b>PROFALL1020KR</b> Page 411</p>	<p><b>PROFALL1425</b> Page 409  <b>PROFALL1425</b> Page 409</p>	
<p><b>FOP1009.30</b> Page 413</p>	<p><b>FOP1011.30</b> Page 413</p>	<p><b>FOP1013.30</b> Page 413</p>		
<p><b>LMU20B.150</b> Page 414  <b>LMU20B.250</b> Page 414  <b>LMU20B.350</b> Page 414</p>	<p><b>LMU20B.150</b> Page 414  <b>LMU20B.250</b> Page 414  <b>LMU20B.350</b> Page 414</p>	<p><b>LMU20B.150</b> Page 414  <b>LMU20B.250</b> Page 414  <b>LMU20B.350</b> Page 414</p>		
<p><b>CANAL06</b> Page 415  <b>CANAL16</b> Page 415  <b>CANAL26</b> Page 415  <b>CANALSU66</b> Page 416</p>	<p><b>CANAL1</b> Page 415  <b>CANAL2</b> Page 415  <b>CANAL3</b> Page 415  <b>CANALSF48</b> Page 416  <b>CANALSU68</b> Page 416  <b>CANALH88</b> Page 416</p>	<p><b>CANAL12</b> Page 415  <b>CANAL22</b> Page 415  <b>CANAL32</b> Page 415  <b>CANALSF50</b> Page 416  <b>CANALSU70</b> Page 416  <b>CANALH90</b> Page 416</p>	<p><b>CANAL13</b> Page 415  <b>CANAL23</b> Page 415  <b>CANAL33</b> Page 415  <b>CANALSF52</b> Page 416  <b>CANALSU72</b> Page 416  <b>CANALH92</b> Page 416</p>	<p><b>CANAL34</b> Page 415</p>
	<p><b>CMIRR8.2000</b> Page 417  <b>CMIRR8.3000</b> Page 417  <b>CANALM01</b> Page 417  <b>CANALM02</b> Page 417  <b>CANALM03</b> Page 417</p>	<p><b>CMIRR10.2000</b> Page 417  <b>CMIRR10.3000</b> Page 417  <b>CANALM012</b> Page 417  <b>CANALM022</b> Page 417  <b>CANALM032</b> Page 417</p>		



**PBD3183 U-SHAPED PROFILE**

Material: Aluminium

Finish: /6 /88 /91 /97

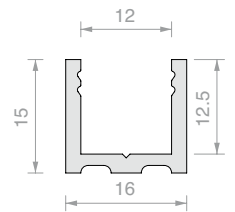

Art.	Length	Qty
<b>PBD3183.150</b>	1498 mm	1 Pc
<b>PBD3183.220</b>	2200 mm	1 Pc
<b>PBD3183</b>	3000 mm	1 Pc



**LMU20 U-SHAPED PROFILE**

Material: Aluminium

Finish: /6 /88 /91 /97

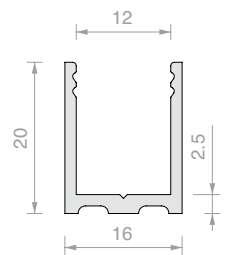

Art.	Length	Qty
<b>LMU20.150</b>	1498 mm	1 Pc
<b>LMU20.300</b>	3000 mm	1 Pc



**ROUNDED UPPER PROFILE**

Material: Aluminium  
 Finish: /6 /88 /91 /97

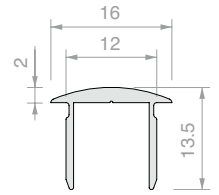

Art.	Length	Qty
<b>PBD3184.100</b>	<b>992 mm</b>	<b>1 Pc</b>
<b>PBD3184.150</b>	<b>1498 mm</b>	<b>1 Pc</b>
<b>PBD3184</b>	<b>3000 mm</b>	<b>1 Pc</b>



**FLAT UPPER PROFILE**

Material: Aluminium  
 Finish: /6 /88 /91 /97

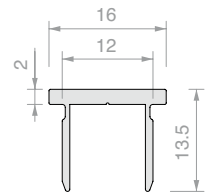

Art.	Length	Qty
<b>PBD3186.100</b>	<b>992 mm</b>	<b>1 Pc</b>
<b>PBD3186.150</b>	<b>1498 mm</b>	<b>1 Pc</b>
<b>PBD3186</b>	<b>3000 mm</b>	<b>1 Pc</b>

**ROUNDED CAP PBD**

Material: Aluminium  
 Finish: /6 /88 /91 /97

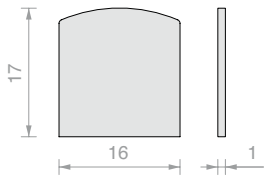

**PBD FLAT CAP**

Material: Aluminium  
 Finish: /6 /88 /91 /97

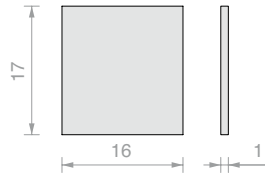

**FLAT CAP LMU**

Material: Aluminium  
 Finish: /88 /91 /97 /R2

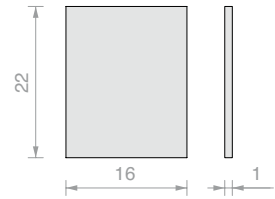

Art.	Qty	Art.	Qty	Art.	Qty
<b>PBDTP</b>	<b>1 Pc</b>	<b>PBD86TP</b>	<b>1 Pc</b>	<b>LMU20TP</b>	<b>1 Pc</b>



**GLASS HOLDER GASKET**

Material: PVC

Art.	Thickness	Colour	Qty	Art.	Thickness	Colour	Qty	Art.	Thickness	Colour	Qty
<b>GTUP2</b>	<b>2 mm</b>	<b>Transparent</b>	<b>1 m</b>	<b>GTUP2G</b>	<b>2 mm</b>	<b>Embossed</b>	<b>1 m</b>	<b>GTUP2N</b>	<b>2 mm</b>	<b>Black</b>	<b>1 m</b>
<b>GTUP3</b>	<b>3 mm</b>	<b>Transparent</b>	<b>1 m</b>	<b>GTUP3G</b>	<b>3 mm</b>	<b>Embossed</b>	<b>1 m</b>	<b>GTUP3N</b>	<b>3 mm</b>	<b>Black</b>	<b>1 m</b>
<b>GTUP4</b>	<b>4 mm</b>	<b>Transparent</b>	<b>1 m</b>	<b>GTUP4G</b>	<b>4 mm</b>	<b>Embossed</b>	<b>1 m</b>	<b>GTUP4N</b>	<b>4 mm</b>	<b>Black</b>	<b>1 m</b>
<b>GTUP5</b>	<b>5 mm</b>	<b>Transparent</b>	<b>1 m</b>	<b>GTUP5G</b>	<b>5 mm</b>	<b>Embossed</b>	<b>1 m</b>	<b>GTUP5N</b>	<b>5 mm</b>	<b>Black</b>	<b>1 m</b>
<b>GTUP6</b>	<b>6 mm</b>	<b>Transparent</b>	<b>1 m</b>	<b>GTUP6G</b>	<b>6 mm</b>	<b>Embossed</b>	<b>1 m</b>	<b>GTUP6N</b>	<b>6 mm</b>	<b>Black</b>	<b>1 m</b>

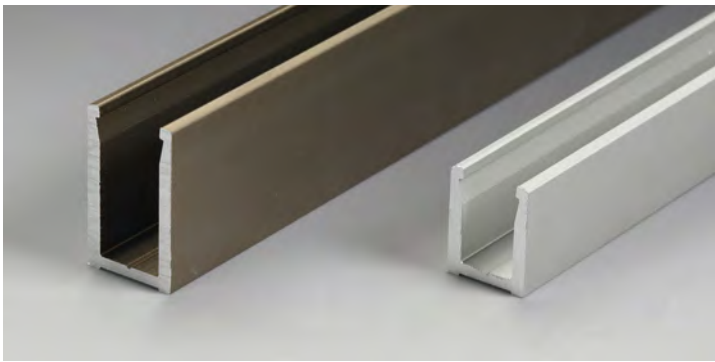

**PROALUX U-SHAPED PROFILE**

Material: Aluminium

Finish: /6 /88 /91 /97

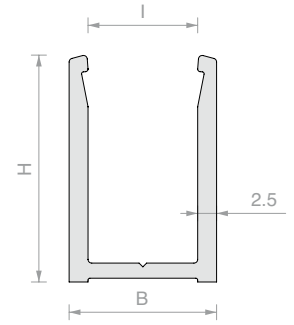

Art.	H	I	B	Length	For glass	Qty
<b>PROALUX1520</b>	20 mm	10.5 mm	15.5 mm	3000 mm	8 mm	1 Pc
<b>PROALUX1530</b>	30 mm	10.5 mm	15.5 mm	3000 mm	8 mm	1 Pc
<b>PROALUX1720</b>	20 mm	12.5 mm	17.5 mm	3000 mm	10 mm	1 Pc
<b>PROALUX1730</b>	30 mm	12.5 mm	17.5 mm	3000 mm	10 mm	1 Pc
<b>PROALUX1920</b>	20 mm	14.5 mm	19.5 mm	3000 mm	12 mm	1 Pc
<b>PROALUX1930</b>	30 mm	14.5 mm	19.5 mm	3000 mm	12 mm	1 Pc



**PROALUX CAPS**

Material: Aluminium

Finish: /88 /91 /97 /R2

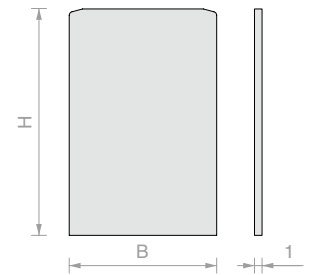

Art.	H	B	Qty
<b>PROTAP1520</b>	20 mm	15.5 mm	1 Pc
<b>PROTAP1530</b>	30 mm	15.5 mm	1 Pc
<b>PROTAP1720</b>	20 mm	17.5 mm	1 Pc
<b>PROTAP1730</b>	30 mm	17.5 mm	1 Pc
<b>PROTAP1920</b>	20 mm	19.5 mm	1 Pc
<b>PROTAP1930</b>	30 mm	19.5 mm	1 Pc

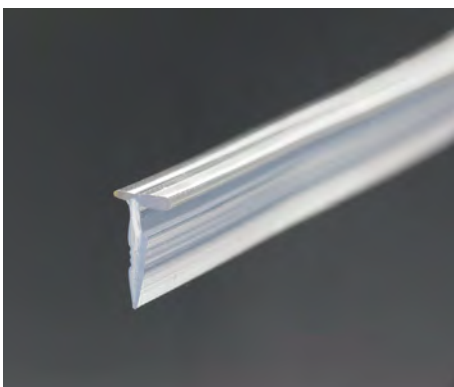

**SEAL FOR PROALUX PROFILES**

Material: Co-extruded PVC

Finish: Transparent

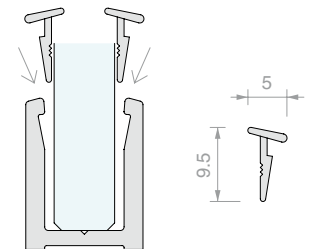

Art.	Description	Qty
<b>PROALUXG</b>		1 m
<b>PROALUXG400</b>	400 m roll	1 Pc



**WHEEL TOOL**

Material: Plastic

For fitting PROFIXG, GTUP and PROALUXG seals

Art.	Qty
<b>UTR65</b>	1 Pc





### PROFALL U-SHAPED PROFILE

Material: Aluminium

Finish: /6 /88 /91 /97

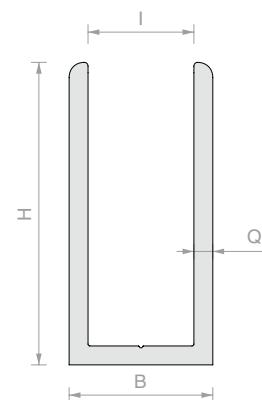

Art.	H	I	B	Q	Length	Qty
<b>PROFALL0820</b>	20 mm	8.5 mm	11.5 mm	1.5 mm	3000 mm	1 Pc
<b>PROFALL1020</b>	20 mm	10.5 mm	13.5 mm	1.5 mm	3000 mm	1 Pc
<b>PROFALL1225</b>	25 mm	12 mm	17 mm	2.5 mm	3000 mm	1 Pc
<b>PROFALL1240</b>	40 mm	12 mm	17 mm	2.5 mm	3000 mm	1 Pc
<b>PROFALL1425</b>	25 mm	14 mm	19 mm	2.5 mm	3000 mm	1 Pc
<b>PROFALL1440</b>	40 mm	14 mm	19 mm	2.5 mm	3000 mm	1 Pc



### PROFALL CAPS

Material: Aluminium

Finish: /88 /91 /97 /R2

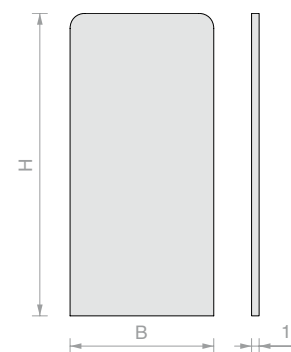

Art.	H	B	Qty
<b>PROTAP0820</b>	20 mm	11.5 mm	1 Pc
<b>PROTAP1020</b>	20 mm	13.5 mm	1 Pc
<b>PROTAP1225</b>	25 mm	17 mm	1 Pc
<b>PROTAP1240</b>	40 mm	17 mm	1 Pc
<b>PROTAP1425</b>	25 mm	19 mm	1 Pc
<b>PROTAP1440</b>	40 mm	19 mm	1 Pc





**PBD3183 CHROME U-SHAPED PROFILE**

Material: Aluminium

Finish: /1

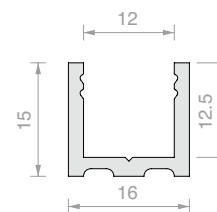

Art.	Length	Qty
<b>PBD3183KR</b>	<b>2997 mm</b>	<b>1 Pc</b>



**ROUNDED UPPER CHROME PROFILE**

Material: Aluminium

Finish: /1

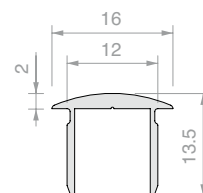

Art.	Length	Qty
<b>PBD3184KR</b>	<b>2997 mm</b>	<b>1 Pc</b>



**PROFALL CHROME U-SHAPED PROFILE**

Material: Aluminium

Finish: /1

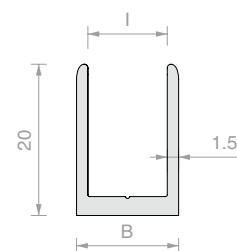

Art.	L	B	Length	Qty
<b>PROFALL0820KR</b>	<b>8.5 mm</b>	<b>11.5 mm</b>	<b>2997 mm</b>	<b>1 Pc</b>
<b>PROFALL1020KR</b>	<b>10.5 mm</b>	<b>13.5 mm</b>	<b>2997 mm</b>	<b>1 Pc</b>



**PROFALL CHROME CAP**

Material: Aluminium

Finish: /1

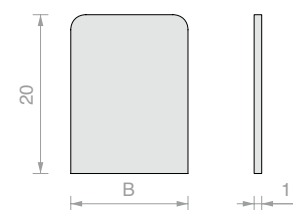

Art.	B	Qty
<b>PROTAP0820KR</b>	<b>11.5 mm</b>	<b>1 Pc</b>
<b>PROTAP1020KR</b>	<b>13.5 mm</b>	<b>1 Pc</b>

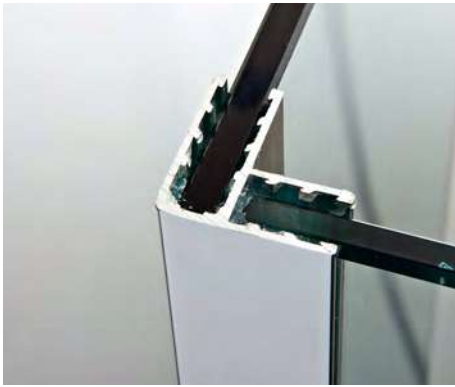

**SPD09 CORNER PROFILE**

Material: Aluminium

Finish: /91

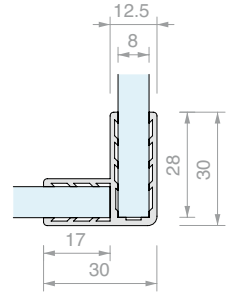

Art.	For glass	Length	Qty
<b>SPD092300</b>	8 mm	2300 mm	1 Pc



**SPD15 CORNER PROFILE**

Material: Aluminium

Finish: /6 /91

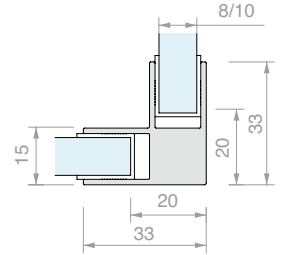

Art.	For glass	Length	Qty
<b>SPD153308</b>	8 mm	2100 mm	1 Pc
<b>SPD153310</b>	10 mm	2100 mm	1 Pc



**SPD11 EXTENSION PROFILE**

Material: Aluminium

Finish: /91

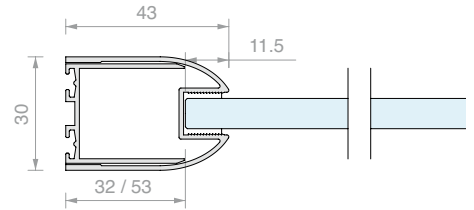

Art.	For glass	Length	Qty
<b>SPD112300</b>	From 8 to 10 mm	2300 mm	1 Pc



**SPD15 EXTENSION PROFILE**

Material: Aluminium

Finish: /6 /91

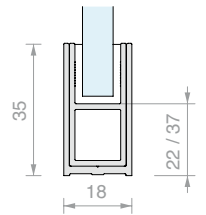

Art.	For glass	Length	Qty
<b>SPD153508</b>	8 mm	2100 mm	1 Pc
<b>SPD153510</b>	10 mm	2100 mm	1 Pc



**SPD13 EXTENSION PROFILE**

Material: Aluminium

Finish: /91

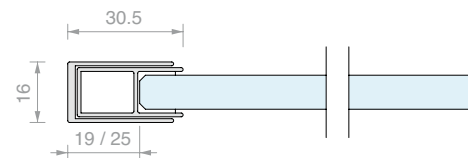

Art.	For glass	Length	Qty
<b>SPD132300</b>	From 8 to 10 mm	2300 mm	1 Pc



### FLAT PROFILE FORME SERIES

Material: Aluminium

Finish:  /6  /88  /97  /RAL

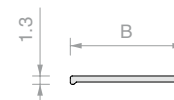

Art.	B	Length	Qty
<b>FOP10.30</b>	10 mm	3000 mm	1 Pc
<b>FOP15.30</b>	15 mm	3000 mm	1 Pc
<b>FOP20.30</b>	20 mm	3000 mm	1 Pc

### L-SHAPED FLAT PROFILE FORME SERIES

Material: Aluminium

Finish:  /6  /88  /97  /RAL

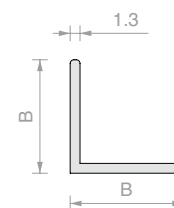

Art.	B	Length	Qty
<b>FOL1010.30</b>	10 mm	3000 mm	1 Pc
<b>FOL1515.30</b>	15 mm	3000 mm	1 Pc
<b>FOL2020.30</b>	20 mm	3000 mm	1 Pc

### U-SHAPED FLAT PROFILE FORME SERIES

Material: Aluminium

Finish:  /6  /88  /97  /RAL

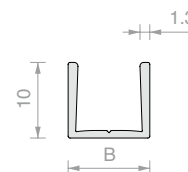

Art.	B	Length	For glass	Qty
<b>FOU1009.30</b>	8.8 mm	3000 mm	6 mm	1 Pc
<b>FOU1011.30</b>	10.8 mm	3000 mm	8 mm	1 Pc
<b>FOU1013.30</b>	12.8 mm	3000 mm	10 mm	1 Pc



### TESA® ACX<sup>plus</sup> DOUBLE-SIDED TAPE

Transparent double-sided tape for structural fixing of glass, steel and aluminium. The paper liner makes manual application of the tape easier. Solid, high performance backing with excellent viscoelastic properties and high bonding power, dissipation of static and dynamic stresses, plus high resistance to temperatures, humidity, UV rays, and chemical agents. Maximum operating temperature 100°C; peak temperature 200°C (max. 20 minutes). Recommended for glass/glass and glass/metal bonding: ideal for compensating different thermal expansions without losing strength. To achieve the best performance, it is recommended to prepare the application surfaces using the specific adhesion promoter, Art. TS100

Art.	Dimensions	Thickness	Qty
<b>TS250065</b>	6 mm x 25 m	0.5 mm	1 Pc
<b>TS25006</b>	6 mm x 25 m	1 mm	1 Pc
<b>TS25009</b>	9 mm x 25 m	1 mm	1 Pc
<b>TS250125</b>	12 mm x 25 m	0.5 mm	1 Pc
<b>TS25012</b>	12 mm x 25 m	1 mm	1 Pc
<b>TS250155</b>	15 mm x 25 m	0.5 mm	1 Pc
<b>TS25019</b>	19 mm x 25 m	1 mm	1 Pc



**LMU20B U-SHAPED PROFILE**

Material: Brass

Finish: /1 /2 /4 /24 /R2

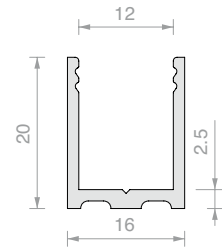

Art.	Length	Qty
<b>LMU20B.150</b>	1498 mm	1 Pc
<b>LMU20B.220</b>	2200 mm	1 Pc
<b>LMU20B.300</b>	3000 mm	1 Pc



**LMU86B FLAT UPPER PROFILE**

Material: Brass

Finish: /1 /2 /4 /24 /R2

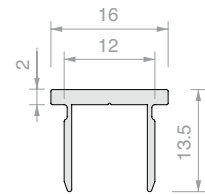

Art.	Length	Qty
<b>LMU86B.100</b>	992 mm	1 Pc
<b>LMU86B.150</b>	1498 mm	1 Pc
<b>LMU86B.300</b>	3000 mm	1 Pc

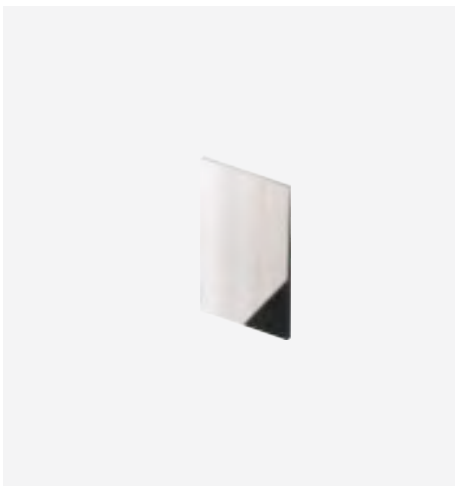

**FLAT CAP LMUB**

Material: Brass

Finish: /1 /2 /4 /24 /R2

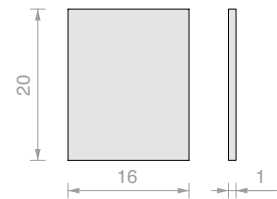

Art.	Qty
<b>LMU20TPB</b>	1 Pc



**WATER BARRIER PROFILE PESQ0810B**

Material: Brass

Finish: /1 /2 /4 /24 /R2

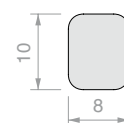

Art.	Length	Qty
<b>PESQ0810B.100</b>	992 mm	1 Pc
<b>PESQ0810B.150</b>	1498 mm	1 Pc
<b>PESQ0810B.300</b>	3000 mm	1 Pc

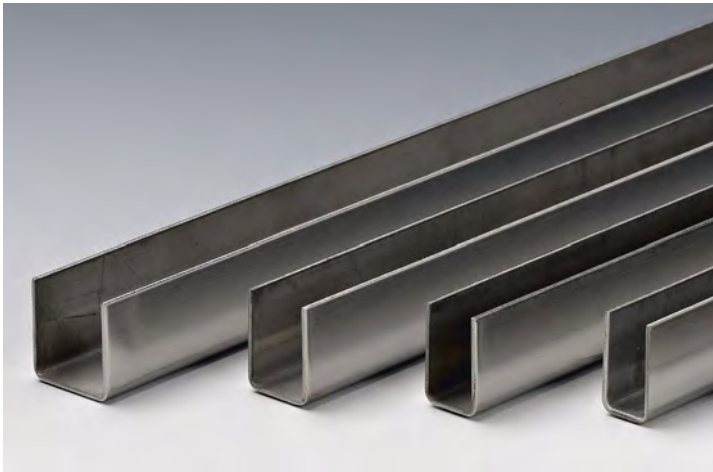
**U-SHAPED CHANNEL**

Material: AISI 304 steel

Finish: /8 /15

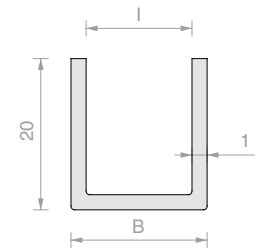

Art.	I	B	Length	Qty
<b>CANAL06</b>	6.5 mm	8.5 mm	2000 mm	1 Pc
<b>CANAL1</b>	8.5 mm	10.5 mm	2000 mm	1 Pc
<b>CANAL12</b>	10.5 mm	12.5 mm	2000 mm	1 Pc
<b>CANAL13</b>	12.5 mm	14.5 mm	2000 mm	1 Pc
<b>CANAL16</b>	6.5 mm	8.5 mm	2500 mm	1 Pc
<b>CANAL2</b>	8.5 mm	10.5 mm	2500 mm	1 Pc
<b>CANAL22</b>	10.5 mm	12.5 mm	2500 mm	1 Pc
<b>CANAL23</b>	12.5 mm	14.5 mm	2500 mm	1 Pc
<b>CANAL26</b>	6.5 mm	8.5 mm	3000 mm	1 Pc
<b>CANAL3</b>	8.5 mm	10.5 mm	3000 mm	1 Pc
<b>CANAL32</b>	10.5 mm	12.5 mm	3000 mm	1 Pc
<b>CANAL33</b>	12.5 mm	14.5 mm	3000 mm	1 Pc
<b>CANAL34</b>	16 mm	18 mm	3000 mm	1 Pc

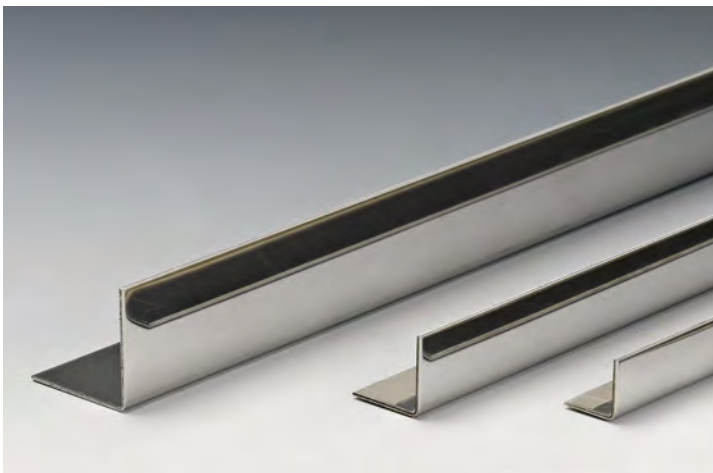
**L-SHAPED CHANNEL**

Material: AISI 304 steel

Finish: /8 /15

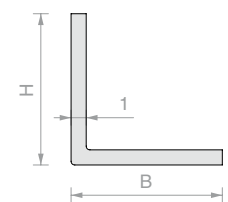

Art.	H	B	Length	Qty
<b>CANANG1</b>	10 mm	10 mm	2000 mm	1 Pc
<b>CANANG12</b>	15 mm	15 mm	2000 mm	1 Pc
<b>CANANG13</b>	20 mm	20 mm	2000 mm	1 Pc
<b>CANANG14</b>	30 mm	30 mm	2000 mm	1 Pc
<b>CANANG2</b>	10 mm	10 mm	2500 mm	1 Pc
<b>CANANG22</b>	15 mm	15 mm	2500 mm	1 Pc
<b>CANANG23</b>	20 mm	20 mm	2500 mm	1 Pc
<b>CANANG24</b>	30 mm	30 mm	2500 mm	1 Pc
<b>CANANG3</b>	10 mm	10 mm	3000 mm	1 Pc
<b>CANANG32</b>	15 mm	15 mm	3000 mm	1 Pc
<b>CANANG33</b>	20 mm	20 mm	3000 mm	1 Pc
<b>CANANG34</b>	30 mm	30 mm	3000 mm	1 Pc

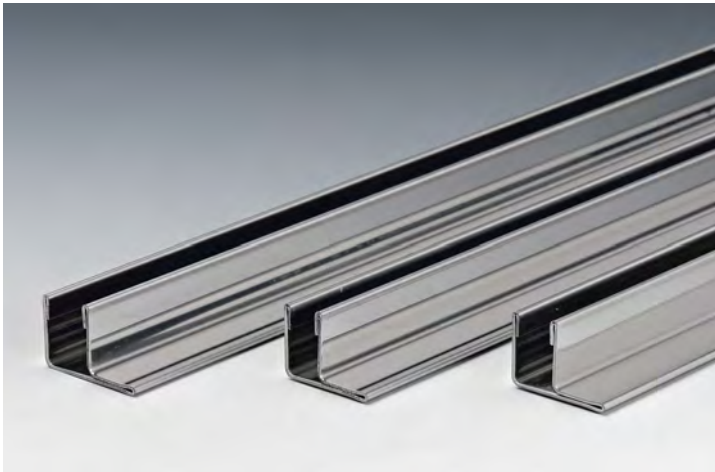

**F-SHAPED CHANNEL**

Material: AISI 304 steel

Finish: /8 /15

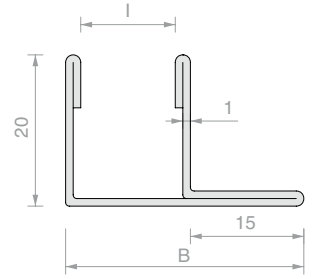

Art.	l	B	Length	Qty
<b>CANALSF48</b>	8.5 mm	27.5 mm	2500 mm	1 Pc
<b>CANALSF50</b>	10.5 mm	29.5 mm	2500 mm	1 Pc
<b>CANALSF52</b>	12.5 mm	31.5 mm	2500 mm	1 Pc

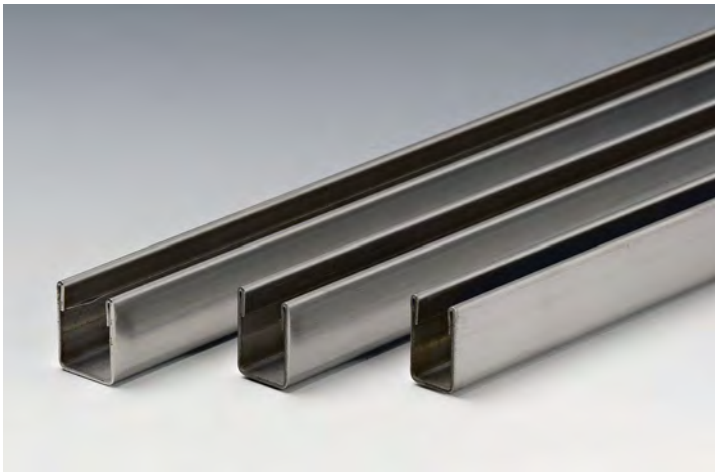

**U-SHAPED CHANNEL WITH FOLDED EDGE**

Material: AISI 304 steel

Finish: /8 /15

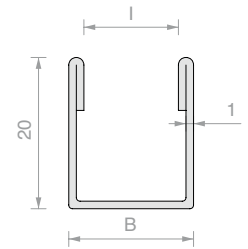

Art.	l	B	Length	Qty
<b>CANALSU66</b>	6.5 mm	10.5 mm	2500 mm	1 Pc
<b>CANALSU68</b>	8.5 mm	12.5 mm	2500 mm	1 Pc
<b>CANALSU70</b>	10.5 mm	14.5 mm	2500 mm	1 Pc
<b>CANALSU72</b>	12.5 mm	16.5 mm	2500 mm	1 Pc



**H-SHAPED CHANNEL WITH FOLDED EDGE**

Material: AISI 304 steel

Finish: /8 /15

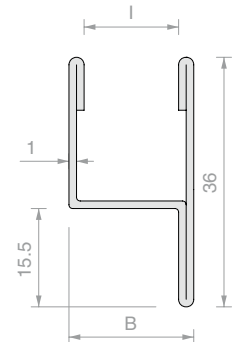

Art.	l	B	Length	Qty
<b>CANALH88</b>	8.5 mm	12.5 mm	2500 mm	1 Pc
<b>CANALH90</b>	10.5 mm	14.5 mm	2500 mm	1 Pc
<b>CANALH92</b>	12.5 mm	16.5 mm	2500 mm	1 Pc





### U-SHAPED MIRROR CHANNEL WITH FOLDED EDGE

Material: AISI 304 steel

Finishes: 8K mirror polished steel

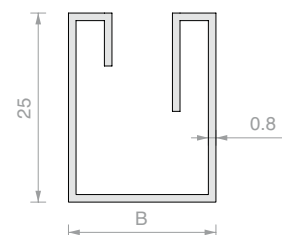

Art.	B	Length	For glass	Qty
<b>CMIRR8.2000</b>	17.5 mm	2000 mm	8 mm	1 Pc
<b>CMIRR8.3000</b>	17.5 mm	3000 mm	8 mm	1 Pc
<b>CMIRR10.2000</b>	19.5 mm	2000 mm	10 mm	1 Pc
<b>CMIRR10.3000</b>	19.5 mm	3000 mm	10 mm	1 Pc



### MIRROR CAP

Material: AISI 304 steel

Finishes: 8K mirror polished steel

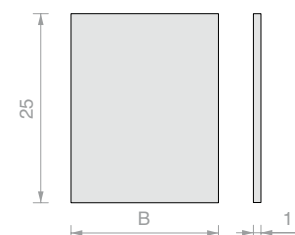

Art.	B	Qty
<b>CMIRRTP8</b>	17.5 mm	1 Pc
<b>CMIRRTP10</b>	19.5 mm	1 Pc



### U-SHAPED MIRROR CHANNEL

Material: AISI 304 steel

Finishes: 6K mirror polished steel

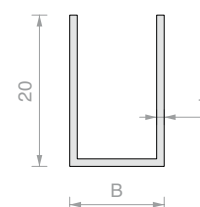

Art.	B	Length	For glass	Qty
<b>CANALM01</b>	10.5 mm	2000 mm	8 mm	1 Pc
<b>CANALM02</b>	10.5 mm	2500 mm	8 mm	1 Pc
<b>CANALM03</b>	10.5 mm	3000 mm	8 mm	1 Pc
<b>CANALM012</b>	12.5 mm	2000 mm	10 mm	1 Pc
<b>CANALM022</b>	12.5 mm	2500 mm	10 mm	1 Pc
<b>CANALM032</b>	12.5 mm	3000 mm	10 mm	1 Pc



**WALL/GLASS  
FLUSH TO THE WALL CLAMP**

Material: Zamak

Finish: /1 /24 /R2

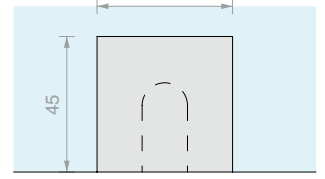
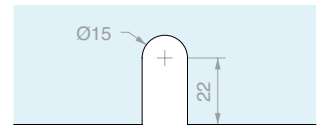
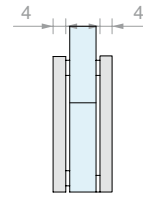

Art.	For glass	Qty
<b>MORSZ001</b>	From 6 to 10 mm	1 Pc



**WALL/GLASS SIDE FIXING CLAMP,  
LARGE**

Material: Zamak

Finish: /1 /24 /R2

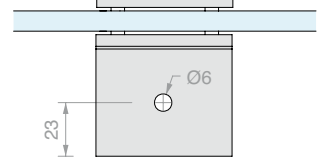
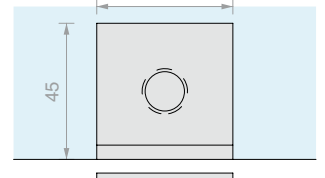
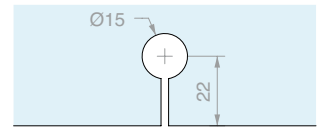
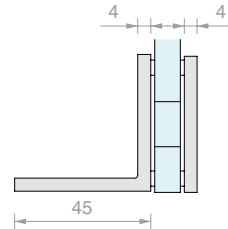

Art.	For glass	Qty
<b>MORSZ002</b>	From 6 to 10 mm	1 Pc



**PAIR OF ROUND KNOBS**

Material: Zamak

Recommended glass hole minimum size Ø12 mm

Finish: /1 /24 /R2

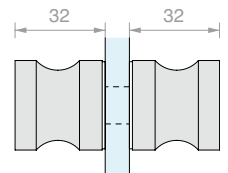
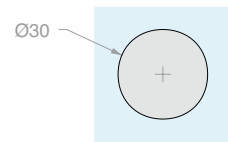

Art.	For glass	Qty
<b>POMZ001</b>	From 6 to 10 mm	1 Pc



**PAIR OF KNOBS WITH GRIP**

Material: Zamak

Recommended glass hole minimum size Ø12 mm

Finish: /1 /24 /R2

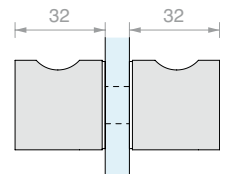
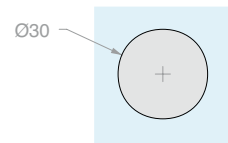

Art.	For glass	Qty
<b>POMZ002</b>	From 6 to 10 mm	1 Pc



**DOOR STRIKER PROFILE**

Material: AISI 304 steel

Finish: /8 /15

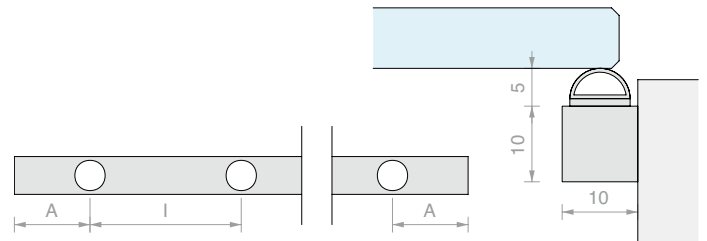

Art.	Length	A	I	Qty
<b>BT2820</b>	2000 mm	100 mm	100 mm	1 Pc
<b>BT28</b>	3000 mm	700 mm	700 mm	1 Pc



**MAGNETIC 45° DOOR STRIKER PROFILE**

Material: Magnetic steel

Properties: to combine with 90° magnetic gasket

Type: GM62DX/SX - GM12DX/SX - GM15DX/SX

Finish: /8 /15

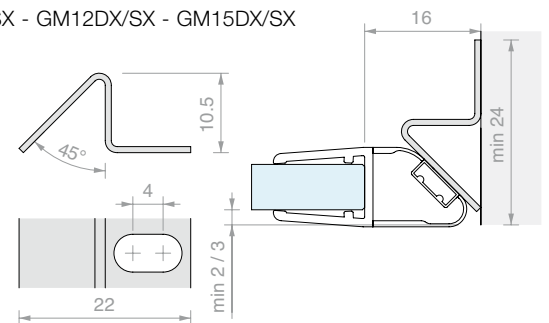

Art.	Length	Qty
<b>BT31</b>	2500 mm	1 Pc



**MAGNETIC 45° DOOR STRIKER PROFILE WITH COVER**

Material: Aluminium, magnet

Finish: /6 /88 /91 /97

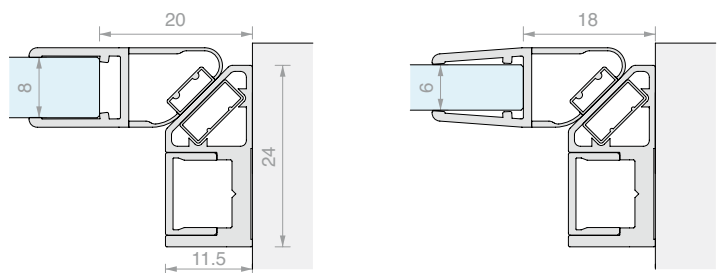

Art.	Length	Qty
<b>BT3322</b>	2200 mm	1 Pc
<b>BT3325</b>	2500 mm	1 Pc



**90° DOOR STRIKER PROFILE**

Material: Aluminium, PVC

Finish: /88 /91 /97

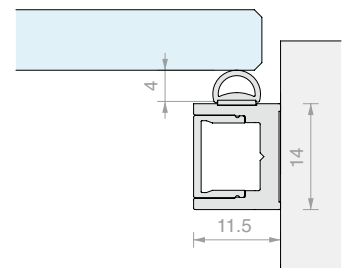

Art.	Length	Qty
<b>BT3520</b>	2000 mm	1 Pc
<b>BT3525</b>	2500 mm	1 Pc

# 500 Series Gaskets

*The resistance of a gasket*  
*The beauty of a finish*

One model for every use.

Choose from among balloon and magnetic gaskets or gaskets with lip deflector or classic straight lip.

The GM500 line comes complete for any type of use.

The flexibility of PVC, the beauty of the finishes.

Add a touch of style to your shower.

The GM500 line is available in black, matt aluminium, polished aluminium and brushed stainless steel.





/6



/88

**BALLOON GASKET**

Material: Co-extruded rigid and soft PVC  
Resistant to UV rays  
Fungicide to prevent mould from forming  
Maximum operating temperature 70°C  
Soft embossed PVC  
Finish: **/6** **/88** **/91** **/97**

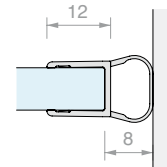

/91



/97

Art.	Length	For glass	Qty
<b>GM50522</b>	2200 mm	From 6 to 8 mm	1 Pc
<b>GM50525</b>	2500 mm	From 6 to 8 mm	1 Pc

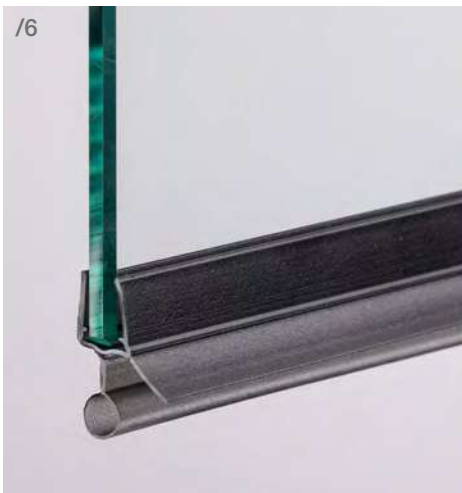

/6



/88

**GASKET WITH BALLOON WATER BARRIER AND DRIP FLAP**

Material: Co-extruded rigid and soft PVC  
Resistant to UV rays  
Fungicide to prevent mould from forming  
Maximum operating temperature 70°C  
Soft embossed PVC  
Finish: **/6** **/88** **/91** **/97**

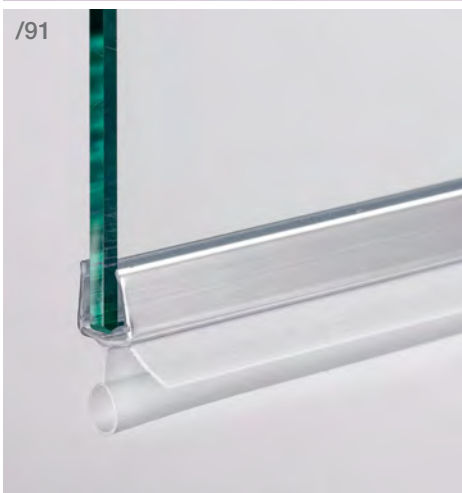
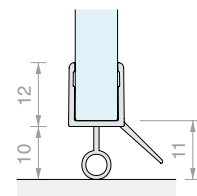

/91



/97

Art.	Length	For glass	Qty
<b>GM56010</b>	1000 mm	From 6 to 8 mm	1 Pc
<b>GM56020</b>	2000 mm	From 6 to 8 mm	1 Pc
<b>GM56025</b>	2500 mm	From 6 to 8 mm	1 Pc



**GASKET WITH SIDE LIP**

Material: Co-extruded rigid and soft PVC  
 Resistant to UV rays  
 Fungicide to prevent mould from forming  
 Maximum operating temperature 70°C  
 Soft embossed PVC  
 Finish: /6 /88 /91 /97

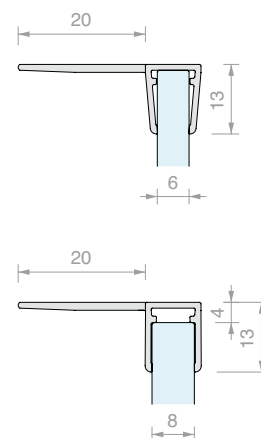

Art.	Length	For glass	Qty
<b>GM57022</b>	2200 mm	From 6 to 8 mm	1 Pc
<b>GM57025</b>	2500 mm	From 6 to 8 mm	1 Pc

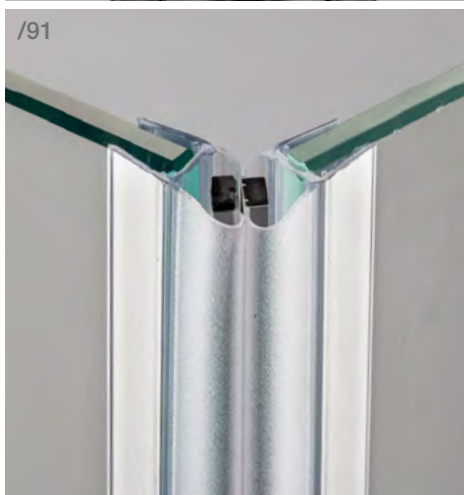
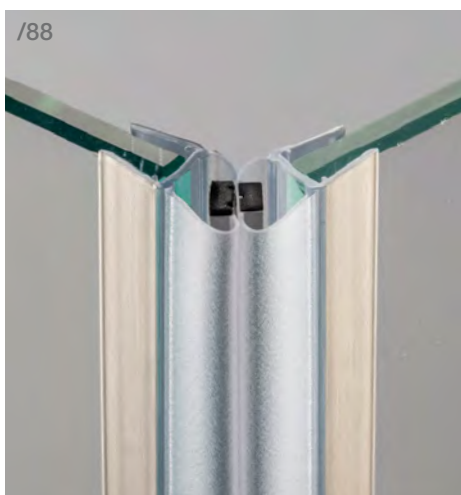

**MAGNETIC 45° GASKET**

Material: Co-extruded rigid and soft PVC  
 Fungicide to prevent mould from forming  
 Maximum operating temperature 70°C  
 Soft embossed PVC  
 Finish: /6 /88 /91 /97

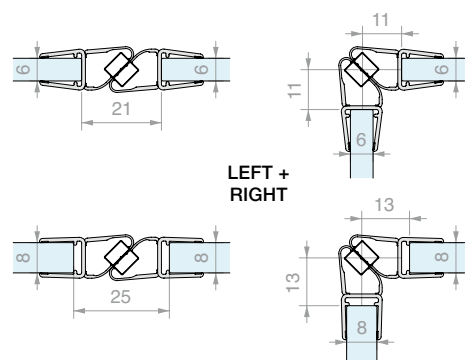

Art.	Length	For glass	Qty
<b>GM512SX25</b>	2500 mm	From 6 to 8 mm	1 Pc
<b>GM512DX25</b>	2500 mm	From 6 to 8 mm	1 Pc

**PAIR OF 45° ADHESIVE MAGNETIC GASKETS**

Material: Co-extruded rigid and soft PVC

Two-sided VHB tape in transparent acrylic foam

- Tri-polar magnet

Maximum operating temperature 70°C

High resistance to UV rays

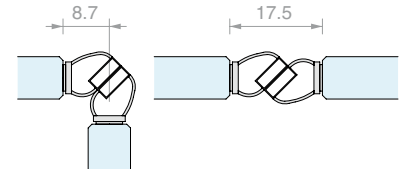

Art.	Length	For glass	Colour	Qty
<b>GMVHB1</b>	2200 mm	From 8 to 12 mm	Transparent	1 Pc
<b>GMVHB1NR</b>	2200 mm	From 8 to 12 mm	Black	1 Pc
<b>GMVHB13000</b>	3000 mm	From 8 to 12 mm	Transparent	1 Pc
<b>GMVHB13000NR</b>	3000 mm	From 8 to 12 mm	Black	1 Pc

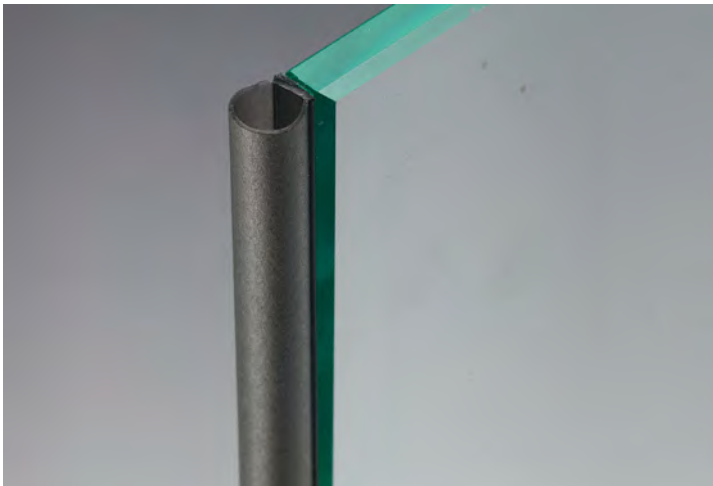
**ADHESIVE BALLOON GASKET**

Material: Co-extruded rigid and soft PVC

Two-sided VHB tape in transparent acrylic foam

Maximum operating temperature 70°C

High resistance to UV rays

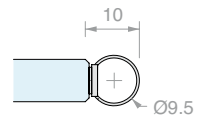

Art.	Length	For glass	Colour	Qty
<b>GMVHB4</b>	2200 mm	From 8 to 12 mm	Transparent	1 Pc
<b>GMVHB4NR</b>	2200 mm	From 8 to 12 mm	Black	1 Pc
<b>GMVHB43000</b>	3000 mm	From 8 to 12 mm	Transparent	1 Pc
<b>GMVHB43000NR</b>	3000 mm	From 8 to 12 mm	Black	1 Pc

**ADHESIVE GASKET WITH STRAIGHT LIP**

Material: Co-extruded rigid and soft PVC

Two-sided VHB tape in transparent acrylic foam

Maximum operating temperature 70°C

High resistance to UV rays

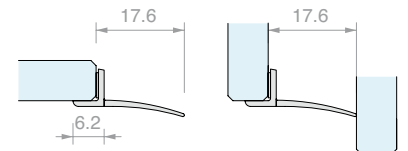

Art.	Length	For glass	Colour	Qty
<b>GMVHB3</b>	2200 mm	From 8 to 12 mm	Transparent	1 Pc
<b>GMVHB3NR</b>	2200 mm	From 8 to 12 mm	Black	1 Pc
<b>GMVHB33000</b>	3000 mm	From 8 to 12 mm	Transparent	1 Pc
<b>GMVHB33000NR</b>	3000 mm	From 8 to 12 mm	Black	1 Pc

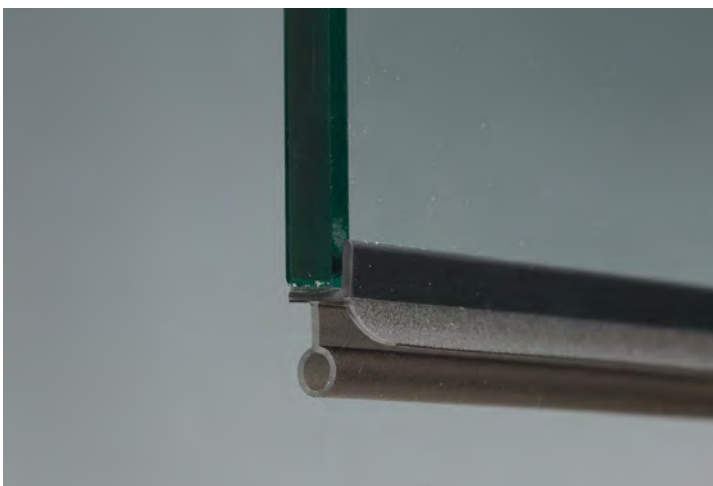
**ADHESIVE GASKET WITH BALLOON WATER BARRIER AND DRIP FLAP**

Material: Co-extruded rigid and soft PVC

Two-sided VHB tape in transparent acrylic foam

Maximum operating temperature 70°C

High resistance to UV rays

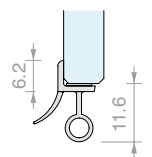

Art.	Length	For glass	Colour	Qty
<b>GMVHB2</b>	2200 mm	From 8 to 12 mm	Transparent	1 Pc
<b>GMVHB2NR</b>	2200 mm	From 8 to 12 mm	Black	1 Pc



**DEGREASING WIPE**

Disposable isopropyl alcohol wipe

Art.	Q.ty
<b>GSLSVL</b>	1 Pc

**FIXGLASS 1000**

Surface preparative for UV bonding.

Product to clean glass before bonding.

This is a concentrated alcohol solution (more than 99%)

It cleans and degreases glass, metal, marble.

ON/OFF nozzle

PRODUCT WITH NO EXPIRY DATE. STORE IN A COOL, SHADY ENVIRONMENT. USE NON-WOVEN TEXTILE CLOTHS FOR APPLICATION.

WARNING: GLOVES RECOMMENDED.

FOR PROFESSIONAL USE

Art.	Size	Qty
<b>FX1000</b>	500 ml	1 Pc

**NON-WOVEN TEXTILE CLOTH**

Product to clean glass before bonding.

Does not leave surface residue.

When used with FIXGLASS 1000, it removes dirt and grease, leaving no streaks.

Art.	Description	Qty
<b>FXTNT01</b>	400 x 250 mm - 50 Cloths	1 Pc

**SILANE GLASS PRIMER 3M VHB**

Adhesion promoter with silane to prepare glass prior to application of VHB two-sided tape.

Procedure:

- The surface must be clean, smooth and dry
- Wet a cloth with the primer
- Apply the primer to the surface, wiping the cloth in only one direction
- Dry the product with a clean, dry cloth immediately after application

Art.	Size	Qty
<b>3MSGP</b>	1000 ml	1 Pc

**BALLOON GASKET**

Material: Co-extruded rigid and soft PVC  
 Resistant to UV rays  
 Fungicide to prevent mould from forming  
 Maximum operating temperature 70°C  
 Colour: transparent, transparent balloon

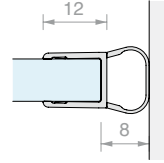

Art.	Length	For glass	Qty
<b>GM62</b>	2200 mm	From 6 to 8 mm	1 Pc
<b>GM6225</b>	2500 mm	From 6 to 8 mm	1 Pc
<b>GM6230</b>	3000 mm	From 6 to 8 mm	1 Pc

**BALLOON GASKET**

Material: Co-extruded rigid and soft PVC  
 Resistant to UV rays  
 Fungicide to prevent mould from forming  
 Colour: transparent, transparent balloon

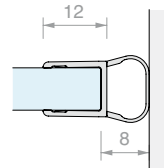

Art.	Length	For glass	Qty
<b>GM05</b>	2000 mm	From 6 to 8 mm	1 Pc
<b>GM0522</b>	2200 mm	From 6 to 8 mm	1 Pc
<b>GM052500</b>	2500 mm	From 6 to 8 mm	1 Pc
<b>GM0530</b>	3000 mm	From 6 to 8 mm	1 Pc

**90° STRIKE JAMB GASKET**

Material: Co-extruded rigid and soft PVC  
 Resistant to UV rays  
 Fungicide to prevent mould from forming  
 Maximum operating temperature 70°C  
 Colour: transparent/\*black, embossed lip

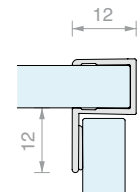

Art.	Length	For glass	Qty
<b>GM58</b>	2200 mm	From 6 to 8 mm	1 Pc
<b>GM58NR*</b>	2200 mm	From 6 to 8 mm	1 Pc
<b>GM5830</b>	3000 mm	From 6 to 8 mm	1 Pc

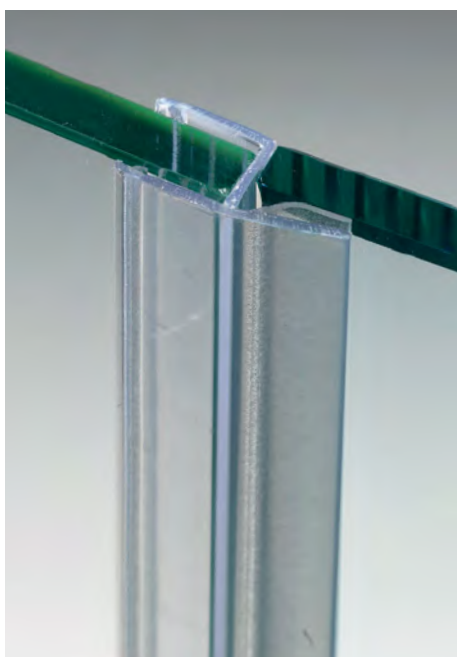

**H-SHAPED GASKET WITH DOOR STRIKER**

Material: Co-extruded rigid and soft PVC  
 Resistant to UV rays  
 Fungicide to prevent mould from forming  
 Colour: transparent, embossed lip

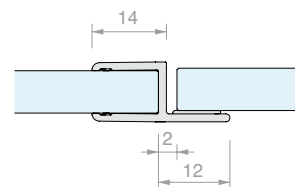

Art.	Length	For glass	Qty
<b>GM01</b>	2000 mm	From 6 to 8 mm	1 Pc
<b>GM012200</b>	2200 mm	From 6 to 8 mm	1 Pc
<b>GM013000</b>	3000 mm	From 6 to 8 mm	1 Pc

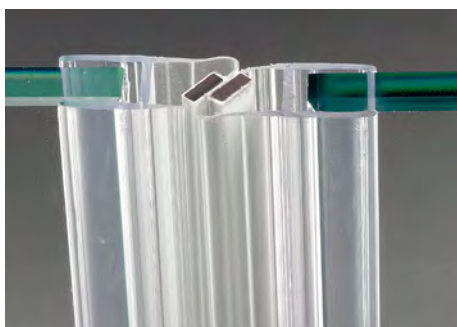

**45° MAGNETIC GASKET WITH WHITE MAGNET**

Material: Co-extruded rigid and soft PVC  
 Resistant to UV rays  
 Fungicide to prevent mould from forming  
 Maximum operating temperature 70°C  
 Colour: transparent, transparent balloon, white magnet

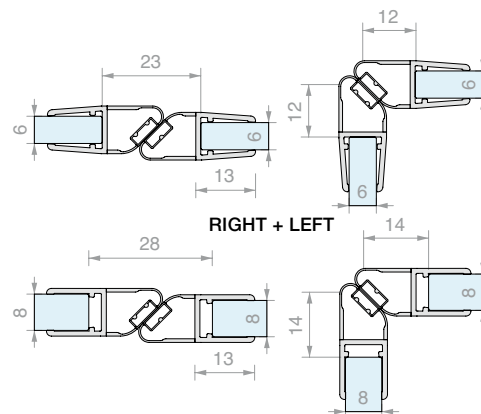

Art.	Length	For glass	Qty
<b>GM62SX</b>	2200 mm	From 6 to 8 mm	1 Pc
<b>GM6230SX</b>	3000 mm	From 6 to 8 mm	1 Pc
<b>GM62DX</b>	2200 mm	From 6 to 8 mm	1 Pc
<b>GM6230DX</b>	3000 mm	From 6 to 8 mm	1 Pc



**45° MAGNETIC GASKET WITH GREY MAGNET**

Material: Co-extruded rigid and soft PVC  
 Maximum operating temperature 70°C  
 Colour: transparent, embossed balloon, grey magnet

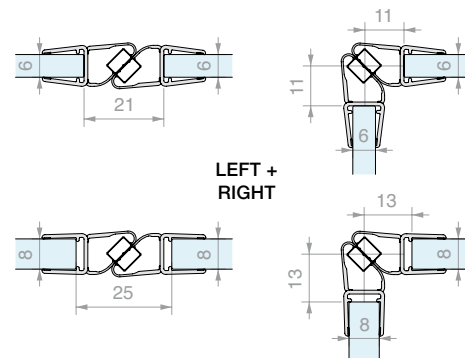

Art.	Length	For glass	Qty
<b>GM12DX20</b>	2000 mm	From 6 to 8 mm	1 Pc
<b>GM12DX22</b>	2200 mm	From 6 to 8 mm	1 Pc
<b>GM12DX25</b>	2500 mm	From 6 to 8 mm	1 Pc
<b>GM12SX20</b>	2000 mm	From 6 to 8 mm	1 Pc
<b>GM12SX22</b>	2200 mm	From 6 to 8 mm	1 Pc
<b>GM12SX25</b>	2500 mm	From 6 to 8 mm	1 Pc

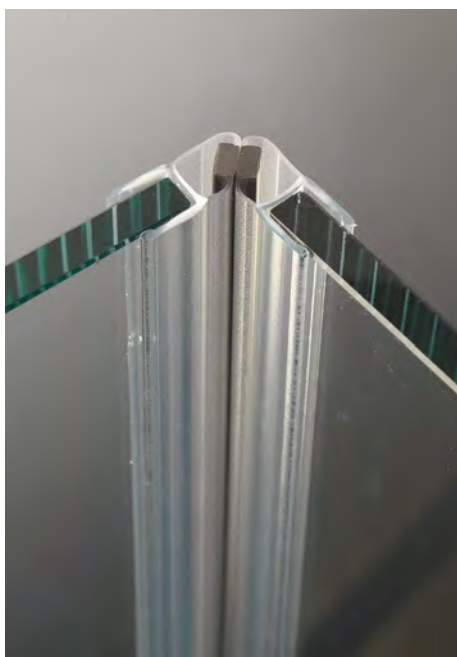



**MAGNETIC IN-LINE GASKET WITH WHITE MAGNET**

Material: Co-extruded rigid and soft PVC  
 Resistant to UV rays  
 Fungicide to prevent mould from forming  
 Maximum operating temperature 70°C  
 Colour: transparent, transparent balloon, white magnet

Art.	Length	For glass	Qty
<b>GM66SX</b>	2200 mm	From 6 to 8 mm	1 Pc
<b>GM6630SX</b>	3000 mm	From 6 to 8 mm	1 Pc
<b>GM66DX</b>	2200 mm	From 6 to 8 mm	1 Pc
<b>GM6630DX</b>	3000 mm	From 6 to 8 mm	1 Pc

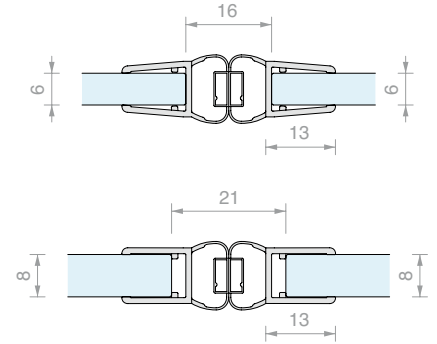

RIGHT + LEFT

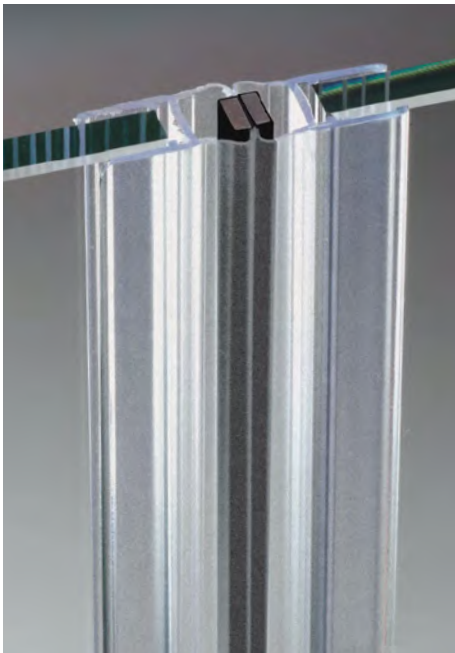

**MAGNETIC IN-LINE GASKET WITH BLACK MAGNET**

Material: Co-extruded rigid and soft PVC  
 Resistant to UV rays  
 Fungicide to prevent mould from forming  
 Colour: transparent, embossed balloon, black magnet

Art.	Length	For glass	Qty
<b>GM11SX</b>	2000 mm	From 6 to 8 mm	1 Pc
<b>GM11SX2500</b>	2500 mm	From 6 to 8 mm	1 Pc
<b>GM11DX</b>	2000 mm	From 6 to 8 mm	1 Pc
<b>GM11DX2500</b>	2500 mm	From 6 to 8 mm	1 Pc

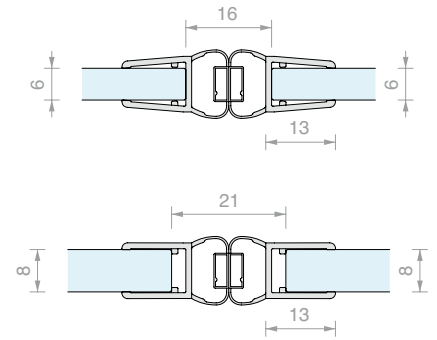

RIGHT + LEFT

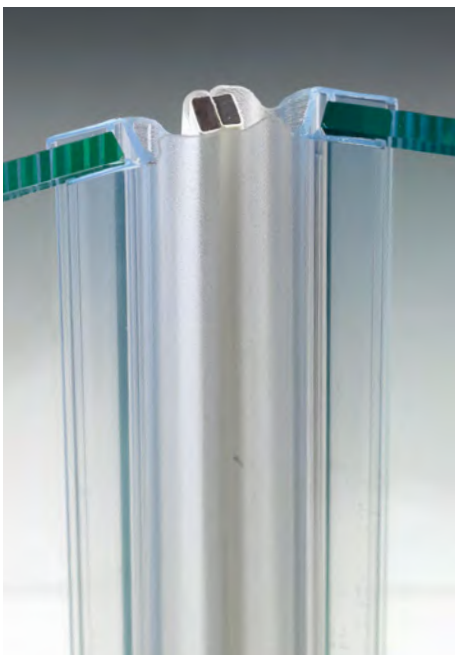

**135° MAGNETIC GASKET WITH WHITE MAGNET**

Material: Co-extruded rigid and soft PVC  
 Resistant to UV rays  
 Fungicide to prevent mould from forming  
 Colour: transparent, embossed balloon, white magnet

Art.	Length	For glass	Qty
<b>GM13SX2200</b>	2200 mm	From 6 to 8 mm	1 Pc
<b>GM13SX3000</b>	3000 mm	From 6 to 8 mm	1 Pc
<b>GM13DX2200</b>	2200 mm	From 6 to 8 mm	1 Pc
<b>GM13DX3000</b>	3000 mm	From 6 to 8 mm	1 Pc

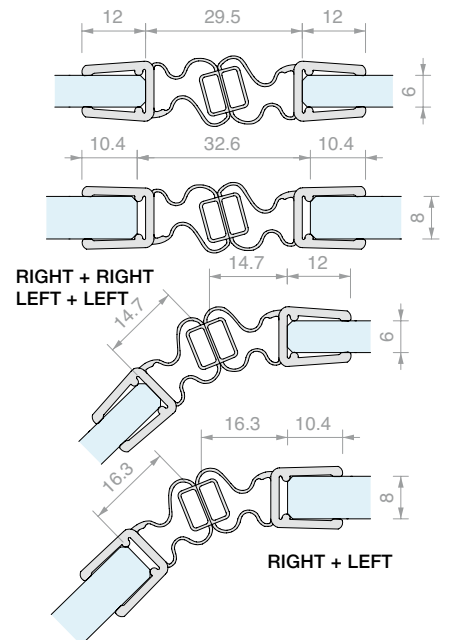

RIGHT + LEFT



### GASKET WITH CURVED LIP

Material: Co-extruded rigid and soft PVC  
Resistant to UV rays  
Fungicide to prevent mould from forming  
Colour: transparent, embossed lip

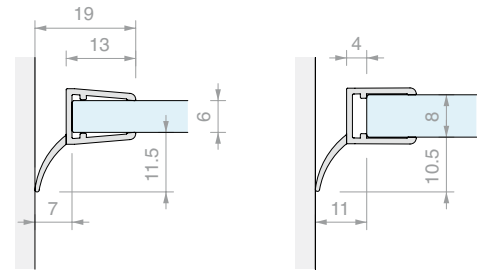

Art.	Length	For glass	Qty
<b>GM0722</b>	2200 mm	From 6 to 8 mm	1 Pc
<b>GM0725</b>	2500 mm	From 6 to 8 mm	1 Pc
<b>GM073000</b>	3000 mm	From 6 to 8 mm	1 Pc

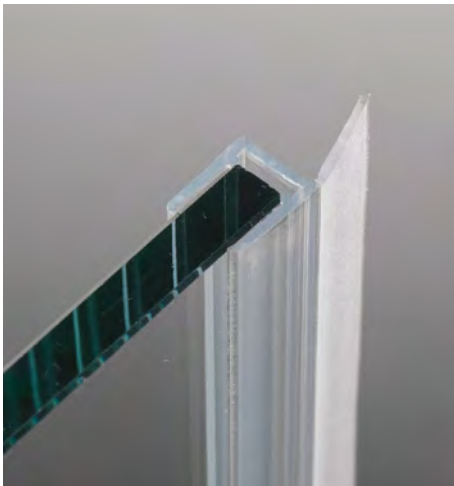

### GASKET WITH STRAIGHT LIP

Material: Co-extruded rigid and soft PVC  
Resistant to UV rays  
Fungicide to prevent mould from forming  
Maximum operating temperature 70°C  
Colour: transparent, embossed lip

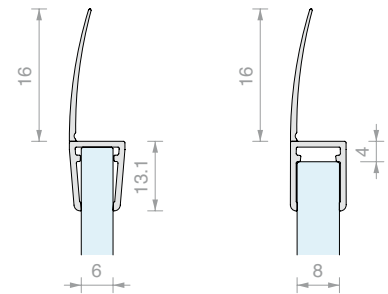

Art.	Length	For glass	Qty
<b>GM7222</b>	2200 mm	From 6 to 8 mm	1 Pc
<b>GM7225</b>	2500 mm	From 6 to 8 mm	1 Pc
<b>GM7230</b>	3000 mm	From 6 to 8 mm	1 Pc

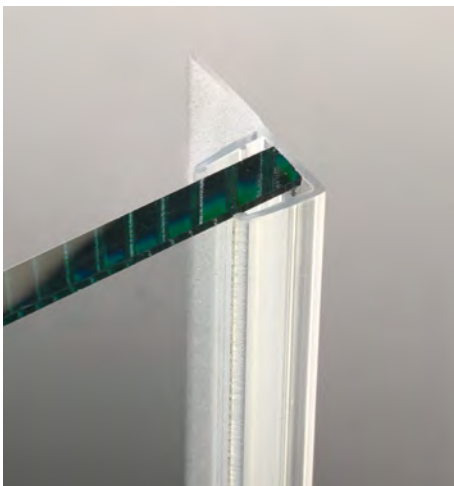

### GASKET WITH SIDE LIP

Material: Co-extruded rigid and soft PVC  
Fungicide to prevent mould from forming  
Colour: transparent, embossed lip

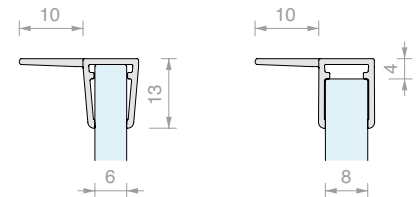

Art.	Length	For glass	Qty
<b>GM7022</b>	2200 mm	From 6 to 8 mm	1 Pc
<b>GM7025</b>	2500 mm	From 6 to 8 mm	1 Pc
<b>GM7030</b>	3000 mm	From 6 to 8 mm	1 Pc

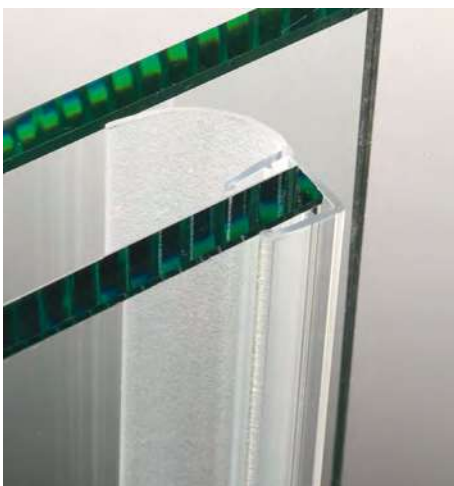

### GASKET WITH SIDE LIP

Material: Co-extruded rigid and soft PVC  
Fungicide to prevent mould from forming  
Finishes: transparent, embossed lip

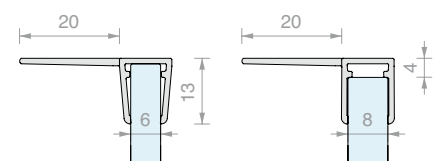

Art.	Length	For glass	Qty
<b>GM702020</b>	2000 mm	From 6 to 8 mm	1 Pc
<b>GM702022</b>	2200 mm	From 6 to 8 mm	1 Pc
<b>GM702030</b>	3000 mm	From 6 to 8 mm	1 Pc

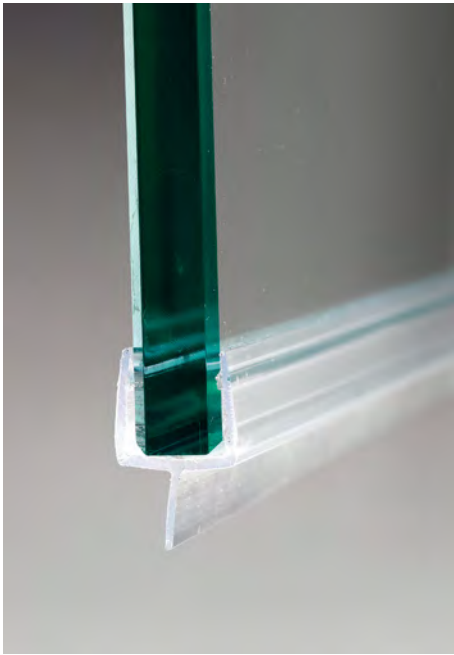
**GASKET WITH CENTRAL LIP**

Material: Co-extruded rigid and soft PVC

Colour: transparent, embossed lip

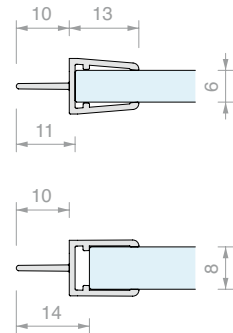

Art.	Length	For glass	Qty
<b>GM8020</b>	2000 mm	From 6 to 8 mm	1 Pc
<b>GM8025</b>	2500 mm	From 6 to 8 mm	1 Pc

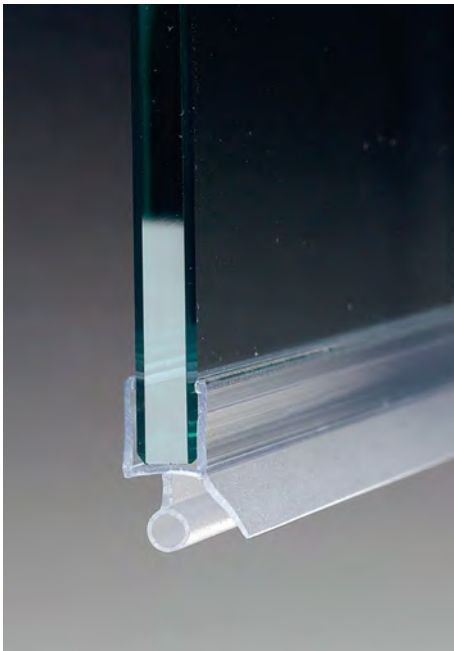
**GASKET WITH BALLOON WATER BARRIER AND DRIP FLAP**

Material: Co-extruded rigid and soft PVC

Resistant to UV rays

Fungicide to prevent mould from forming

Maximum operating temperature 70°C

Colour: transparent, embossed lip and balloon

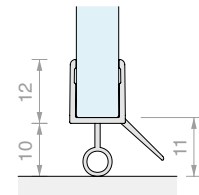

Art.	Length	For glass	Qty
<b>GM6010</b>	1000 mm	From 6 to 8 mm	1 Pc
<b>GM6020</b>	2000 mm	From 6 to 8 mm	1 Pc
<b>GM6025</b>	2500 mm	From 6 to 8 mm	1 Pc
<b>GM6030</b>	3000 mm	From 6 to 8 mm	1 Pc

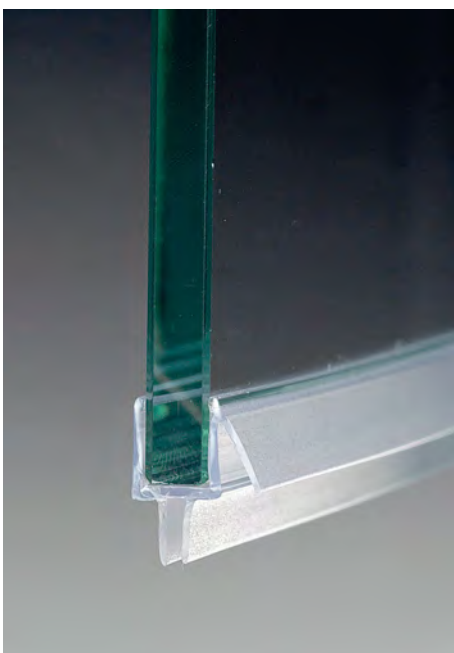
**GASKET WITH DOUBLE-LIP WATER BARRIER AND DRIP FLAP**

Material: Co-extruded rigid and soft PVC

Resistant to UV rays

Fungicide to prevent mould from forming

Maximum operating temperature 70°C

Colour: transparent, embossed lips

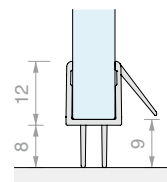

Art.	Length	For glass	Qty
<b>GM5610</b>	1000 mm	From 6 to 8 mm	1 Pc
<b>GM5620</b>	2000 mm	From 6 to 8 mm	1 Pc
<b>GM5625</b>	2500 mm	From 6 to 8 mm	1 Pc
<b>GM5630</b>	3000 mm	From 6 to 8 mm	1 Pc



**90° STRIKE JAMB GASKET**

Material: Co-extruded rigid and soft PVC  
 Resistant to UV rays  
 Fungicide to prevent mould from forming  
 Maximum operating temperature 70°C  
 Colour: transparent, embossed lip

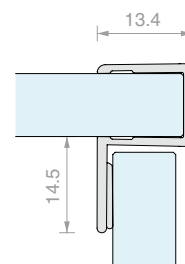

Art.	Length	For glass	Qty
<b>GM5422</b>	2200 mm	From 8 to 10 mm	1 Pc
<b>GM5430</b>	3000 mm	From 8 to 10 mm	1 Pc

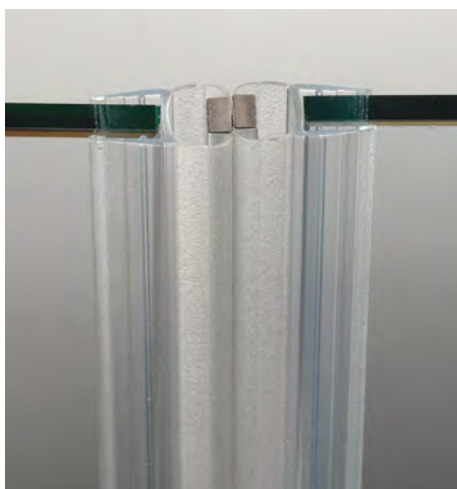

**MAGNETIC IN-LINE GASKET**

Material: Co-extruded rigid and soft PVC  
 Resistant to UV rays  
 Fungicide to prevent mould from forming  
 Maximum operating temperature 70°C  
 Colour: transparent, embossed balloon, white magnet

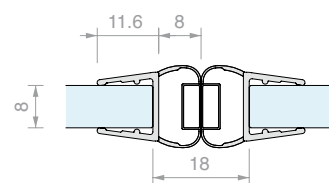

RIGHT + LEFT

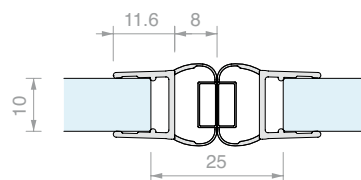

Art.	Length	For glass	Qty
<b>GM1720SX</b>	2200 mm	From 8 to 10 mm	1 Pc
<b>GM1720DX</b>	2200 mm	From 8 to 10 mm	1 Pc
<b>GM17SX</b>	2500 mm	From 8 to 10 mm	1 Pc
<b>GM17DX</b>	2500 mm	From 8 to 10 mm	1 Pc
<b>GM1730SX</b>	3000 mm	From 8 to 10 mm	1 Pc
<b>GM1730DX</b>	3000 mm	From 8 to 10 mm	1 Pc

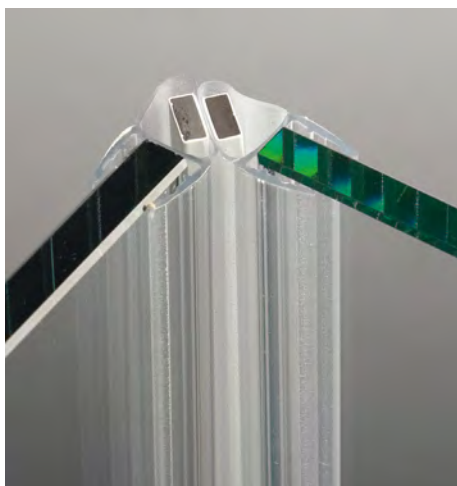

**MAGNETIC 45° GASKET**

Material: Co-extruded rigid and soft PVC - Resistant to UV rays  
 Fungicide to prevent mould from forming  
 Maximum operating temperature 70°C  
 Colour: transparent/\*black, transparent balloon, white/\*black magnet

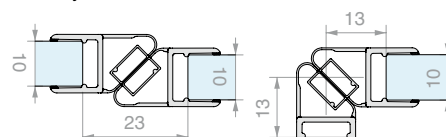

RIGHT + LEFT

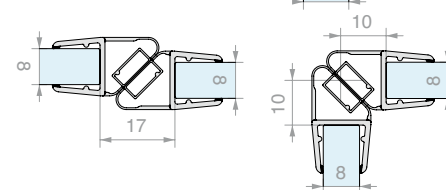

Art.	Length	For glass	Qty
<b>GM1520SX</b>	2200 mm	From 8 to 10 mm	1 Pc
<b>GM1520SXNR*</b>	2200 mm	From 8 to 10 mm	1 Pc
<b>GM1520DX</b>	2200 mm	From 8 to 10 mm	1 Pc
<b>GM1520DXNR*</b>	2200 mm	From 8 to 10 mm	1 Pc
<b>GM15SX</b>	2500 mm	From 8 to 10 mm	1 Pc
<b>GM15DX</b>	2500 mm	From 8 to 10 mm	1 Pc
<b>GM1530SX</b>	3000 mm	From 8 to 10 mm	1 Pc
<b>GM1530DX</b>	3000 mm	From 8 to 10 mm	1 Pc

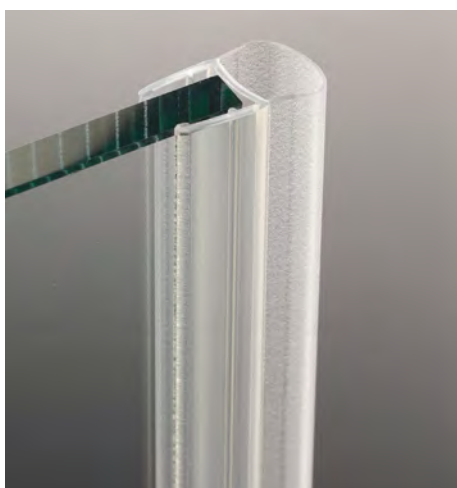

**BALLOON GASKET**

Material: Co-extruded rigid and soft PVC - Resistant to UV rays  
 Fungicide to prevent mould from forming  
 Colour: transparent/\*black, embossed balloon

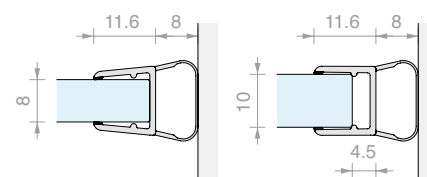

Art.	Length	For glass	Qty
<b>GM06</b>	2000 mm	From 8 to 10 mm	1 Pc
<b>GM0622</b>	2200 mm	From 8 to 10 mm	1 Pc
<b>GM0622NR*</b>	2200 mm	From 8 to 10 mm	1 Pc
<b>GM0625</b>	2500 mm	From 8 to 10 mm	1 Pc
<b>GM0625NR*</b>	2500 mm	From 8 to 10 mm	1 Pc
<b>GM063000</b>	3000 mm	From 8 to 10 mm	1 Pc
<b>GM063000NR*</b>	3000 mm	From 8 to 10 mm	1 Pc

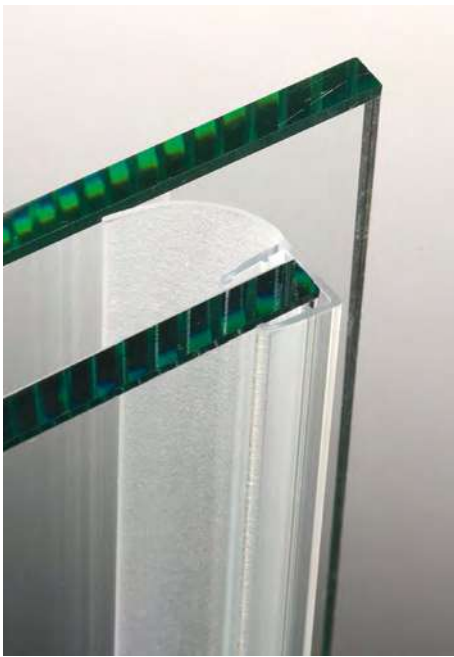
**GASKET WITH LONG SIDE LIP**

Material: Co-extruded rigid and soft PVC  
Resistant to UV rays  
Fungicide to prevent mould from forming  
Colour: transparent/\*black, embossed lip

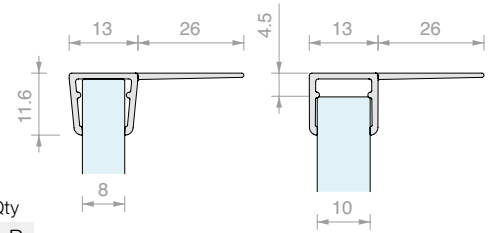

Art.	Length	For glass	Qty
<b>GM014</b>	2000 mm	From 8 to 10 mm	1 Pc
<b>GM01422</b>	2200 mm	From 8 to 10 mm	1 Pc
<b>GM01422NR*</b>	2200 mm	From 8 to 10 mm	1 Pc
<b>GM01425</b>	2500 mm	From 8 to 10 mm	1 Pc
<b>GM01425NR*</b>	2500 mm	From 8 to 10 mm	1 Pc
<b>GM0143000</b>	3000 mm	From 8 to 10 mm	1 Pc
<b>GM0143000NR*</b>	3000 mm	From 8 to 10 mm	1 Pc

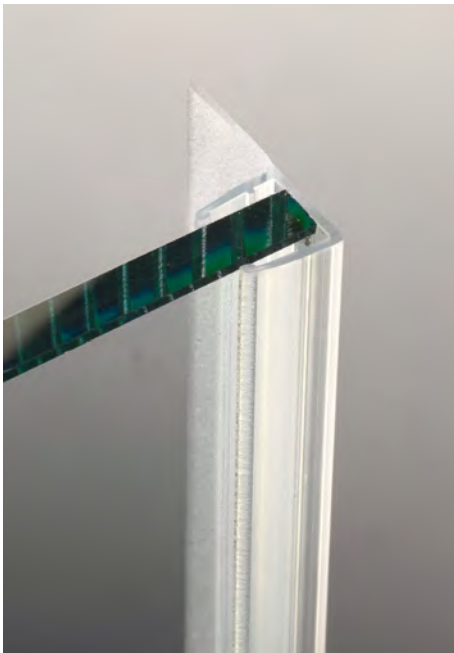
**GASKET WITH SHORT SIDE LIP**

Material: Co-extruded rigid and soft PVC  
Fungicide to prevent mould from forming  
Colour: transparent, embossed lip

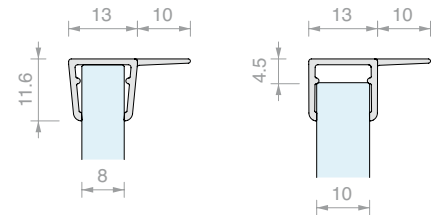

Art.	Length	For glass	Qty
<b>GM01410</b>	2000 mm	From 8 to 10 mm	1 Pc
<b>GM0141022</b>	2200 mm	From 8 to 10 mm	1 Pc
<b>GM0141025</b>	2500 mm	From 8 to 10 mm	1 Pc

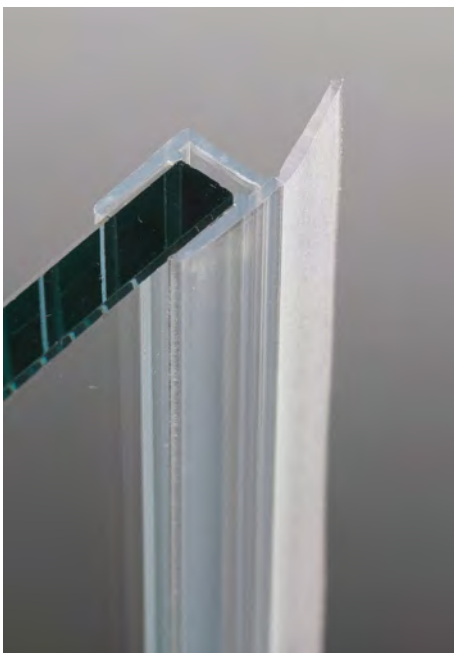
**GASKET WITH STRAIGHT LIP**

Material: Co-extruded rigid and soft PVC  
Fungicide to prevent mould from forming  
Colour: transparent, embossed lip

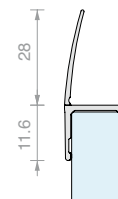

Art.	Length	For glass	Qty
<b>GM04</b>	2000 mm	From 8 to 10 mm	1 Pc
<b>GM0422</b>	2200 mm	From 8 to 10 mm	1 Pc
<b>GM0425</b>	2500 mm	From 8 to 10 mm	1 Pc
<b>GM0430</b>	3000 mm	From 8 to 10 mm	1 Pc





### GASKET WITH LIP WATER BARRIER AND DRIP FLAP

Material: Co-extruded rigid and soft PVC  
 Resistant to UV rays  
 Fungicide to prevent mould from forming  
 Maximum operating temperature 70°C  
 Colour: transparent/\*black, embossed lips

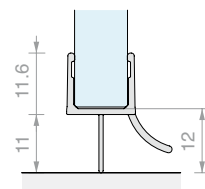

Art.	Length	For glass	Qty
<b>GM0210</b>	1000 mm	From 8 to 10 mm	1 Pc
<b>GM02</b>	2000 mm	From 8 to 10 mm	1 Pc
<b>GM02NR*</b>	2000 mm	From 8 to 10 mm	1 Pc
<b>GM022500</b>	2500 mm	From 8 to 10 mm	1 Pc
<b>GM022500NR*</b>	2500 mm	From 8 to 10 mm	1 Pc

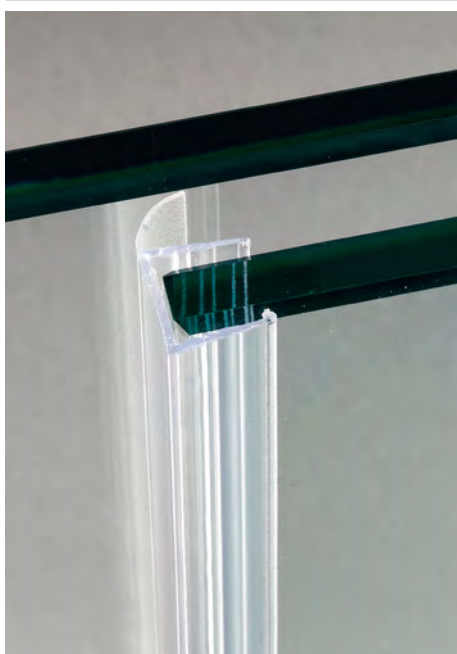

### GASKET WITH SIDE LIP

Material: Co-extruded rigid and soft PVC  
 Resistant to UV rays  
 Fungicide to prevent mould from forming  
 Maximum operating temperature 70°C  
 Colour: transparent, embossed lip

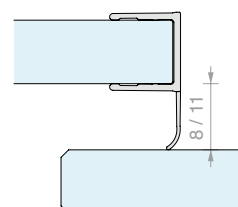
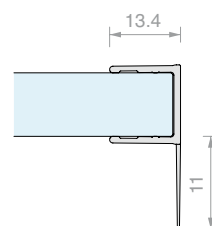

Art.	Length	For glass	Qty
<b>GM40</b>	2200 mm	From 10 to 12 mm	1 Pc
<b>GM4025</b>	2500 mm	From 10 to 12 mm	1 Pc
<b>GM4030</b>	3000 mm	From 10 to 12 mm	1 Pc



### BALLOON GASKET

Material: Co-extruded rigid and soft PVC  
 Resistant to UV rays  
 Fungicide to prevent mould from forming  
 Maximum operating temperature 70°C  
 Colour: transparent, transparent balloon

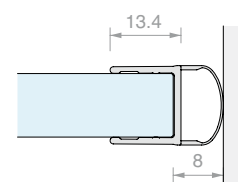

Art.	Length	For glass	Qty
<b>GM42</b>	2200 mm	From 10 to 12 mm	1 Pc
<b>GM4225</b>	2500 mm	From 10 to 12 mm	1 Pc
<b>GM4230</b>	3000 mm	From 10 to 12 mm	1 Pc

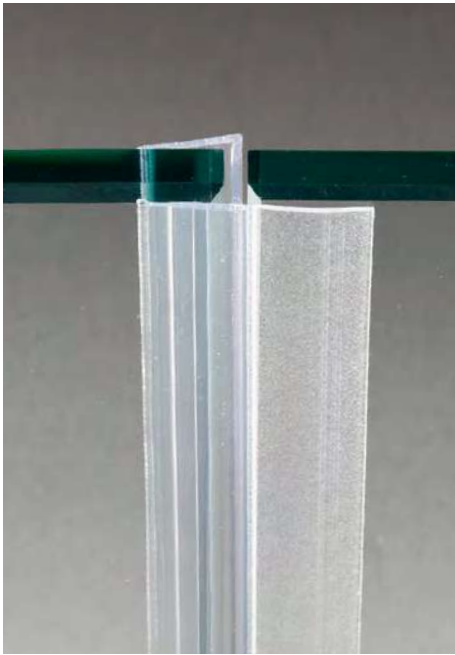

**GASKET WITH STRAIGHT LIP**

Material: Co-extruded rigid and soft PVC  
 Resistant to UV rays  
 Fungicide to prevent mould from forming  
 Maximum operating temperature 70°C  
 Colour: transparent, embossed lip

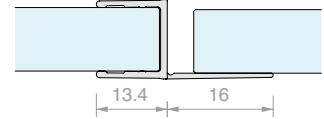

Art.	Length	For glass	Qty
<b>GM44</b>	2200 mm	From 10 to 12 mm	1 Pc
<b>GM4425</b>	2500 mm	From 10 to 12 mm	1 Pc
<b>GM4430</b>	3000 mm	From 10 to 12 mm	1 Pc



**H-SHAPED GASKET WITH DOOR STRIKER**

Material: Co-extruded rigid and soft PVC  
 Resistant to UV rays  
 Fungicide to prevent mould from forming  
 Maximum operating temperature 70°C  
 Colour: transparent, embossed lip

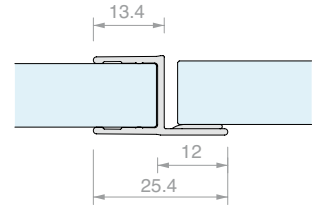

Art.	Length	For glass	Qty
<b>GM46</b>	2200 mm	From 10 to 12 mm	1 Pc
<b>GM4625</b>	2500 mm	From 10 to 12 mm	1 Pc
<b>GM4630</b>	3000 mm	From 10 to 12 mm	1 Pc



**90° STRIKE JAMB GASKET**

Material: Co-extruded rigid and soft PVC  
 Resistant to UV rays  
 Fungicide to prevent mould from forming  
 Maximum operating temperature 70°C  
 Colour: transparent, embossed lip

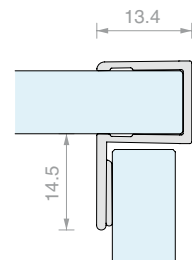

Art.	Length	For glass	Qty
<b>GM50</b>	2200 mm	From 10 to 12 mm	1 Pc
<b>GM5030</b>	3000 mm	From 10 to 12 mm	1 Pc

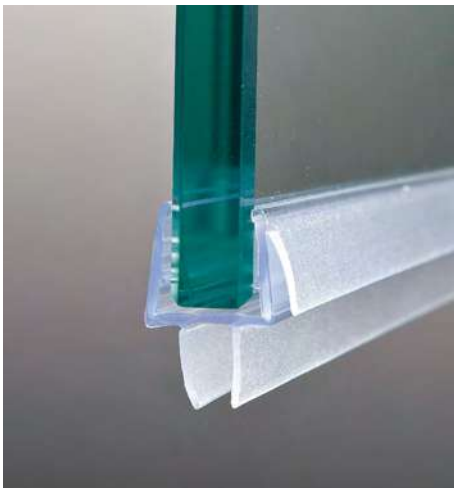

### GASKET WITH DOUBLE-LIP WATER BARRIER AND DRIP FLAP

Material: Co-extruded rigid and soft PVC  
 Resistant to UV rays  
 Fungicide to prevent mould from forming  
 Maximum operating temperature 70°C  
 Colour: transparent, embossed lips

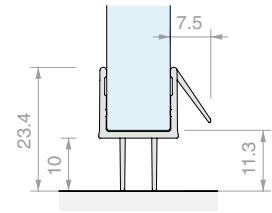

Art.	Length	For glass	Qty
<b>GM4810</b>	1000 mm	From 10 to 12 mm	1 Pc
<b>GM4822</b>	2200 mm	From 10 to 12 mm	1 Pc
<b>GM4825</b>	2500 mm	From 10 to 12 mm	1 Pc
<b>GM4830</b>	3000 mm	From 10 to 12 mm	1 Pc



### GASKET WITH BALLOON WATER BARRIER AND DRIP FLAP

Material: Co-extruded rigid and soft PVC  
 Resistant to UV rays  
 Fungicide to prevent mould from forming  
 Maximum operating temperature 70°C  
 Colour: transparent, embossed lip and balloon

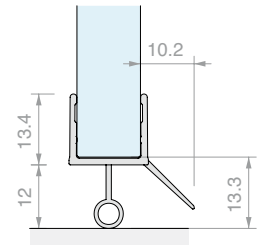

Art.	Length	For glass	Qty
<b>GM5210</b>	1000 mm	From 10 to 12 mm	1 Pc
<b>GM5222</b>	2200 mm	From 10 to 12 mm	1 Pc
<b>GM5225</b>	2500 mm	From 10 to 12 mm	1 Pc
<b>GM5230</b>	3000 mm	From 10 to 12 mm	1 Pc



### SHEARS FOR CUTTING GASKETS

Material: steel with slip-proof handle  
 Blade length 50 mm  
 With safety latch  
 Ambidextrous use.

Art.	Qty
<b>GMPINZ</b>	1 Pc



### SHEARS WITH GRADUATED BASE FOR CUTTING GASKETS

Material: steel with slip-proof handle  
 Graduated base for inclined cuts  
 Blade length 50 mm  
 With safety latch  
 Ambidextrous use.

Art.	Qty
<b>GMPINZ02</b>	1 Pc



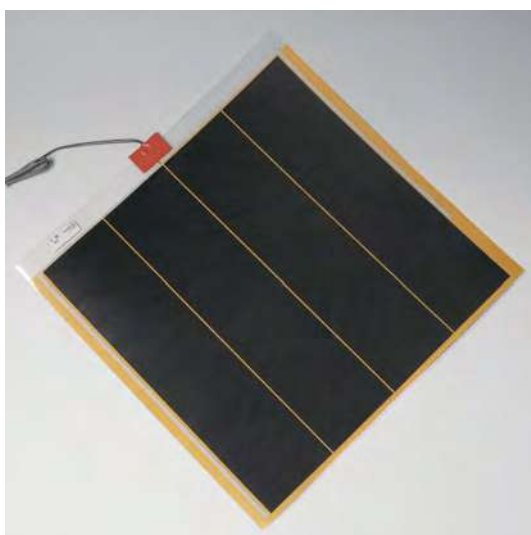

### STOPVAPOR

The StopVapor defogging panel guarantees perfect clarity of the mirror surface where it is applied.

StopVapor is self-adhesive, meets European safety regulations (EN 60335) and bears CE marking.

Safety standards: This device is exclusively for interior use. Avoid direct contact with water. Install only for intended uses. Do not fold the heating sheet.

Do not apply to metal, plastic, wood, cardboard surfaces. Apply only to mirrors.

Do not install on mirrors with holes.

Maintain a distance of 5 mm between the mirror and wall.

Power cable supplied without plug.

Wiring must be done by qualified personnel.

**Warning! If the heating sheet is removed, it CANNOT be reused.**

Art.	Dimensions	Power	Voltage - Frequency	Qty
<b>STOPVAPOR0</b>	<b>280 mm x 280 mm</b>	16 watt	230 V - 50 Hz	1 Pc
<b>STOPVAPOR05</b>	<b>410 mm x 280 mm</b>	24 watt	230 V - 50 Hz	1 Pc
<b>STOPVAPOR1</b>	<b>500 mm x 500 mm</b>	55 watt	230 V - 50 Hz	1 Pc
<b>STOPVAPOR3</b>	<b>680 mm x 580 mm</b>	80 watt	230 V - 50 Hz	1 Pc
<b>STOPVAPOR4</b>	<b>850 mm x 580 mm</b>	100 watt	230 V - 50 Hz	1 Pc
<b>STOPVAPOR2</b>	<b>1010 mm x 440 mm</b>	105 watt	230 V - 50 Hz	1 Pc
<b>STOPVAPOR12</b>	<b>1250 mm x 280 mm</b>	70 watt	230 V - 50 Hz	1 Pc
<b>STOPVAPOR13</b>	<b>1380 mm x 400 mm</b>	110 watt	230 V - 50 Hz	1 Pc
<b>STOPVAPOR15</b>	<b>1500 mm x 360 mm</b>	100 watt	230 V - 50 Hz	1 Pc
<b>STOPVAPOR17</b>	<b>1580 mm x 400 mm</b>	125 watt	230 V - 50 Hz	1 Pc
<b>STOPVAPOR19</b>	<b>1550 mm x 550 mm</b>	170 watt	230 V - 50 Hz	1 Pc



### PROTECTIVE ADHESIVE FILM FOR MIRRORS

MACbak 7000 is a polyolefin fabric, spread with an acrylic adhesive, rolled on itself with no protection.

When applied to the back of a mirror, MACbak 7000 meets the requirements of American standard Z97.1-987 and British standard BS6206, category A.

ADHESIVE PERFORMANCE	Average values	Method used
Initial tack (N)	12	FTM 9
Peeling (N/25 mm) on stainless steel		
- 30 mins	10	FTM 1
- 24 hours	12	
Adhesion (hours)	150	FTM 8

### TAPE PROPERTIES

Thickness (tape-adhesive)	135 µm	ISO 534
Breaking strength (N)	150	ASTMD 2261
Tensile strength (N/15 mm)	SM200	DIN 53455
	ST 110	

### TEMPERATURE RESISTANCE

Minimum application temperature	0°C
Operating temperature range	-40°C/+80°C

### CHEMICAL RESISTANCE

(after 24 hours of immersion)

Water	Excellent
Salt water	Excellent
2% detergent	Excellent
SAE 30 oil	Good
Benzene	Good

Art.	Dimensions	Thickness	Qty
<b>PEL31</b>	<b>1078 mm x 30.5 mm</b>	<b>0.13 mm</b>	<b>1 Pc</b>

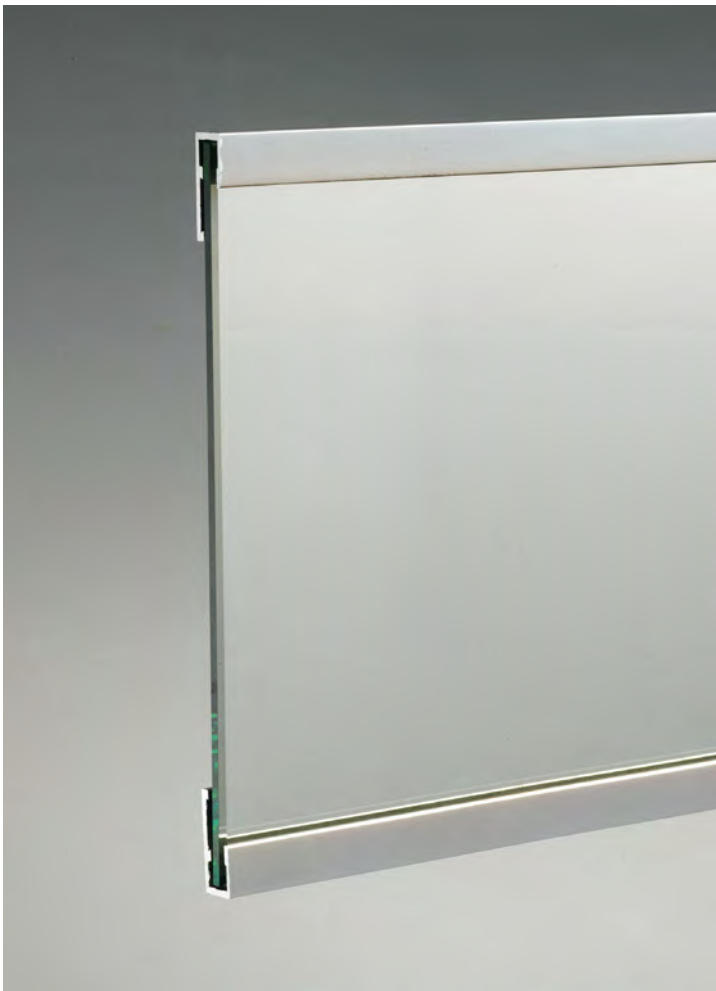

### SUPPORT PROFILE FOR SINGLE MIRROR

Material: Aluminium

Finish: /1 /97

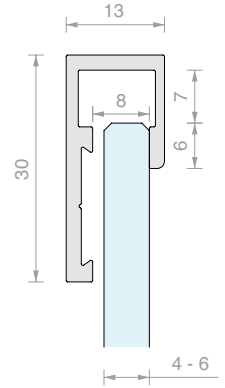

Art.	For glass	Length	Qty
<b>MTS3000</b>	From 4 to 6 mm	<b>3000 mm</b>	1 Pc
<b>MTS3000KR</b>	From 4 to 6 mm	<b>2997 mm</b>	1 Pc



### DOUBLE SUPPORT PROFILE FOR MIRROR

Material: Aluminium

Finish: /97

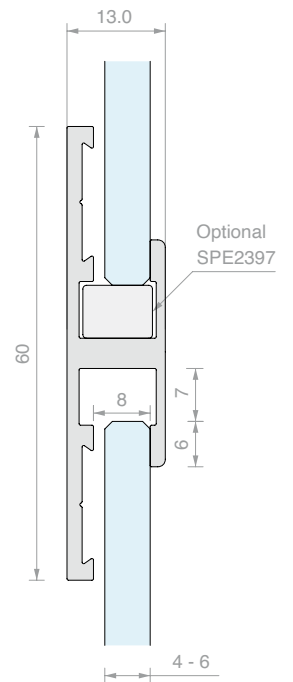

Art.	For glass	Length	Qty
<b>MTD3000</b>	From 4 to 6 mm	<b>3000 mm</b>	1 Pc

**MODULAR LOCKING ACCESSORY**

Material: Plastic (POM)

The fixing plate for profiles MTS/MTD may be split at various points to create the right thickness for 4- or 6-mm mirrors and for insertion to the right, left or middle of the profile.

Colour: Light grey

Art.

Qty

**MTS10**

1 Pc

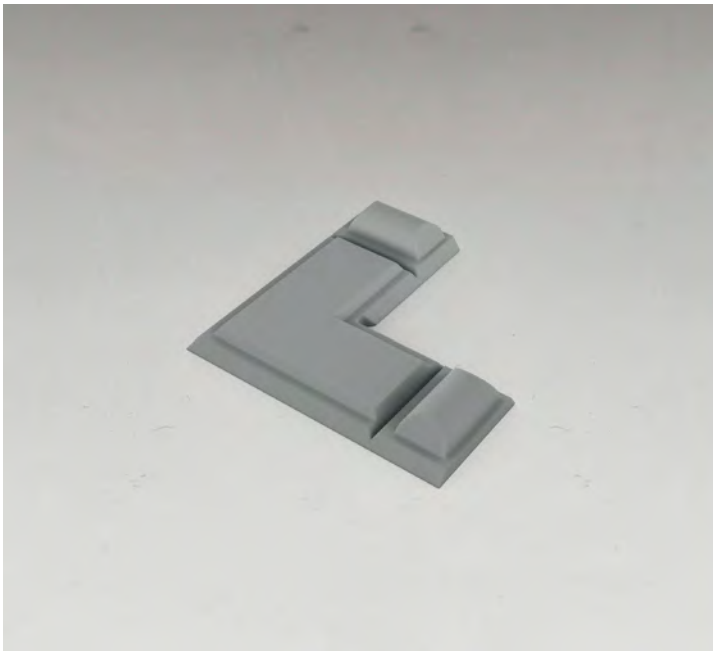
**90° JUNCTION ACCESSORY**

Material: Plastic (POM)

The plate allows 2 MTS or MTD profiles to be joined at 90° to create frames with aluminium profiles for holding the mirror.

Colour: Light grey

Art.

Qty

**MTS90**

1 Pc

**PLASTIC SHIMS**

Insert the shim in the MTS and MTD profiles under the mirror about every 200 mm.

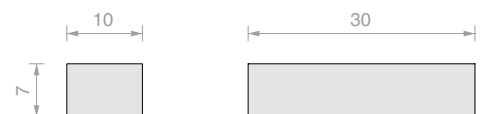

Art.

Package

Qty

**SPE2397**

≈ 400 Pc

1 kg

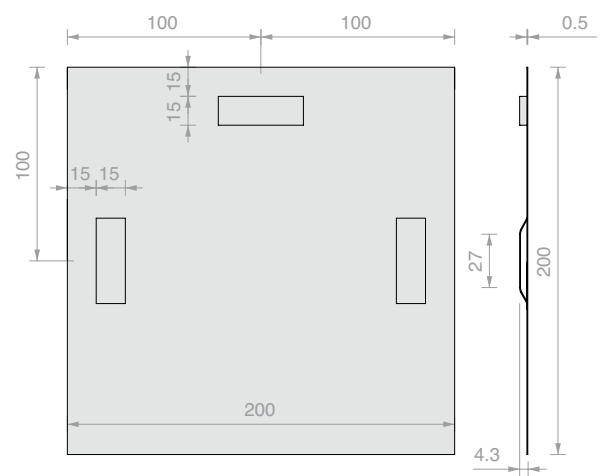
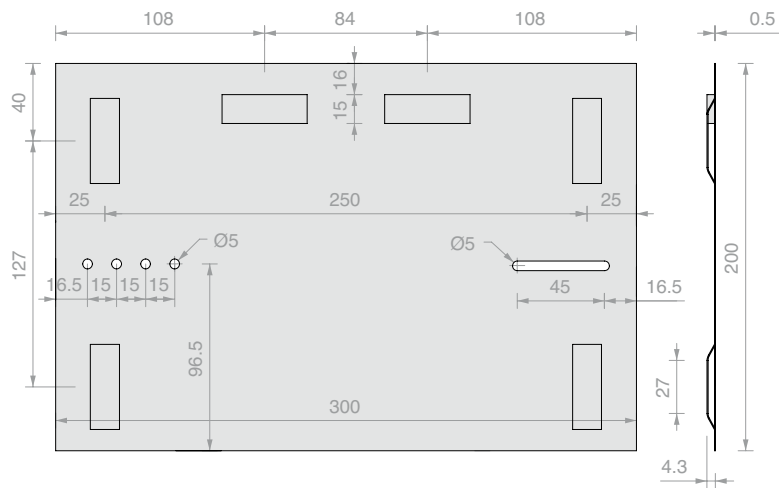
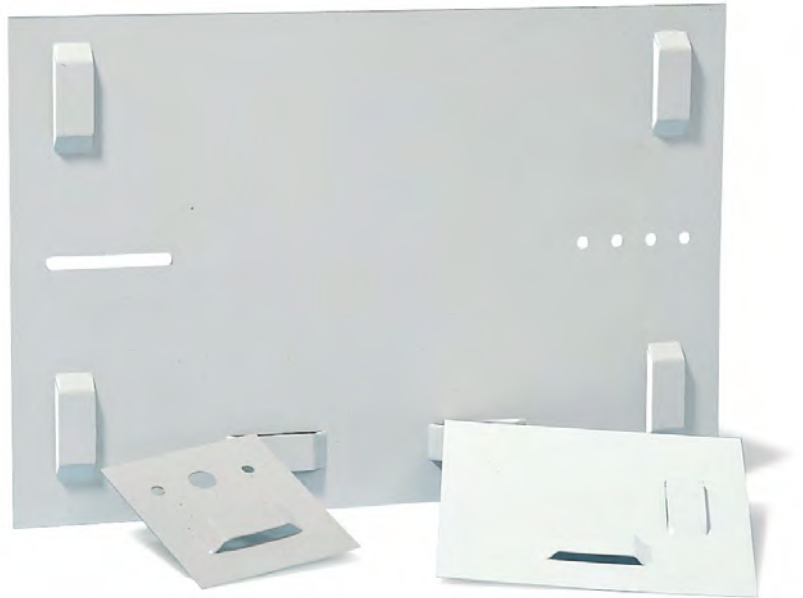

**PLATE FOR ANCHORING MIRRORS**

Material: Pre-painted AVP sheet metal

With holes for anchoring

to accessories ATECO and ATEC5.



Art.	Dimensions	Qty	Art.	Dimensions	Qty
<b>LR300</b>	H 200 x 300 mm	1 Pc	<b>LR320</b>	H 200 x 200 mm	1 Pc

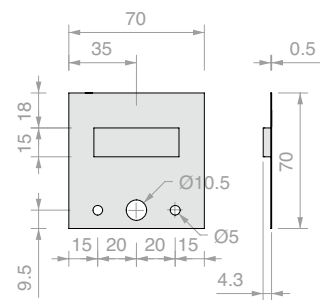
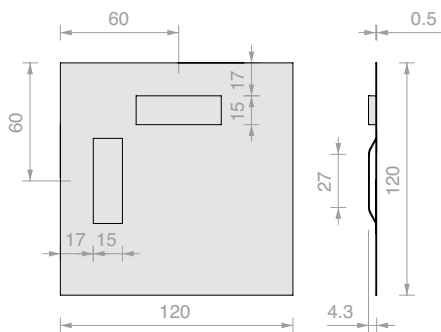

Art.	Dimensions	Qty	Art.	Dimensions	Qty
<b>LR400</b>	H 120 x 120 mm	1 Pc	<b>LR500</b>	H 70 x 70 mm	1 Pc





**PAIR OF ECCENTRIC FIXINGS FOR SHEET METAL**

Material: POM  
Colour: White

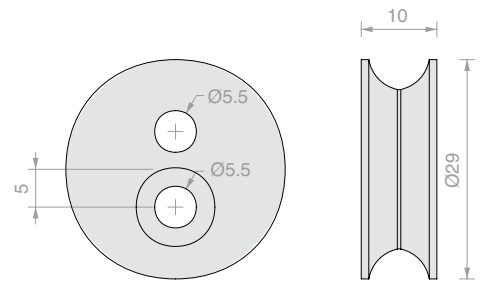

Art.

**ATEC5**

Q.ty

1 Pc



**PAIR OF ECCENTRIC FIXINGS FOR SHEET METAL**

Material: POM  
Colour: White

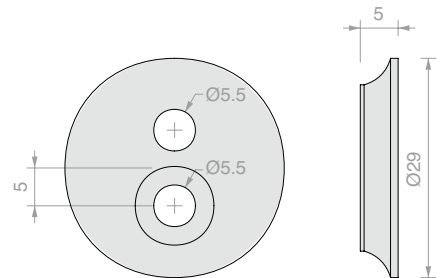

Art.

**ATEC0**

Q.ty

1 Pc

**PAIR OF FRAMES FOR ANCHORING MIRRORS**

Material: Pre-painted AVP sheet metal



Art.	Dimensions	Qty
<b>LR900</b>	H 1100 x 150 x 24 mm	1 Pc
<b>LR1000</b>	H 800 x 150 x 24 mm	1 Pc
<b>LR1100</b>	H 600 x 150 x 24 mm	1 Pc



**W61 PROFILE FOR MIRROR SUPPORT**

Material: Aluminium

Finish: /97

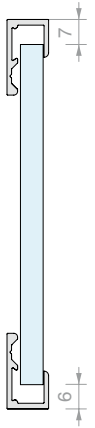
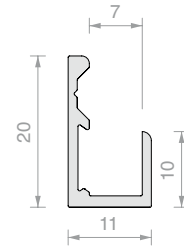

Art.	Length	Qty
<b>W61250</b>	2498 mm	1 Pc
<b>W61500</b>	5000 mm	1 Pc

**END CAPS FOR W61 PROFILES**

Material: Plastic

Colour: Light grey



Art.	Description	Qty	Art.	Description	Qty
<b>W61TSX</b>	Left	1 Pc	<b>W61TDX</b>	Right	1 Pc



**W63 PROFILE FOR MIRROR SUPPORT**

Material: Aluminium

Finish: /97

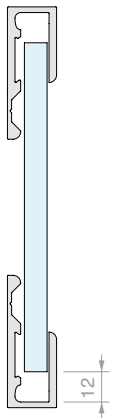
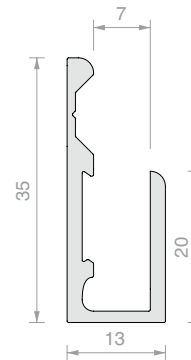

Art.	Length	Qty
<b>W63250</b>	2498 mm	1 Pc
<b>W63500</b>	5000 mm	1 Pc

**END CAPS FOR W63 PROFILES**

Material: Plastic

Colour: Light grey

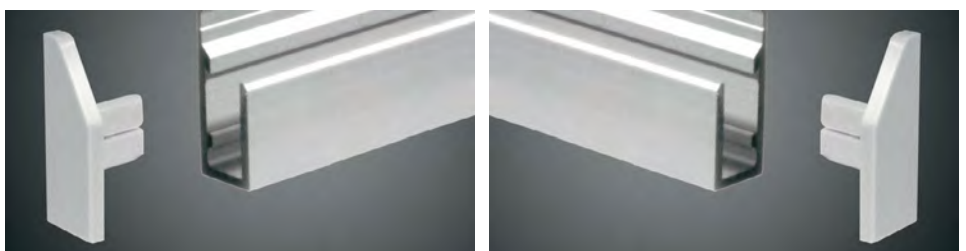

Art.	Description	Qty	Art.	Description	Qty
<b>W63TSX</b>	Left	1 Pc	<b>W63TDX</b>	Right	1 Pc



**4 MIRROR HOLDERS 20**

Material: Brass

Finish: /1 /3

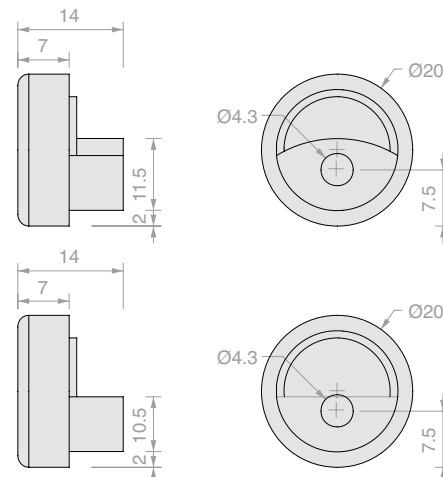

Art.	For glass	Qty
<b>MIR20</b>	6 mm	1 Pc



**4 MIRROR HOLDERS 25**

Material: Brass

Finish: /1 /3

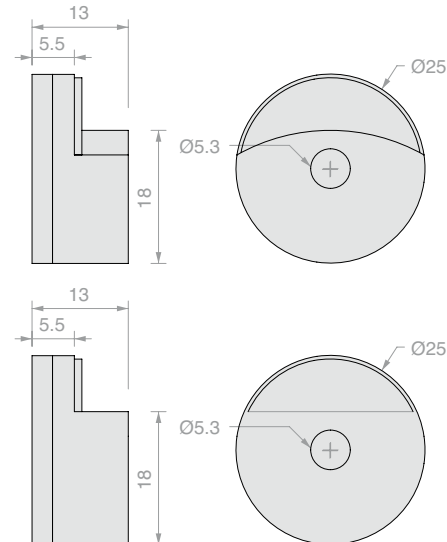

Art.	For glass	Qty
<b>MIR25</b>	6 mm	1 Pc

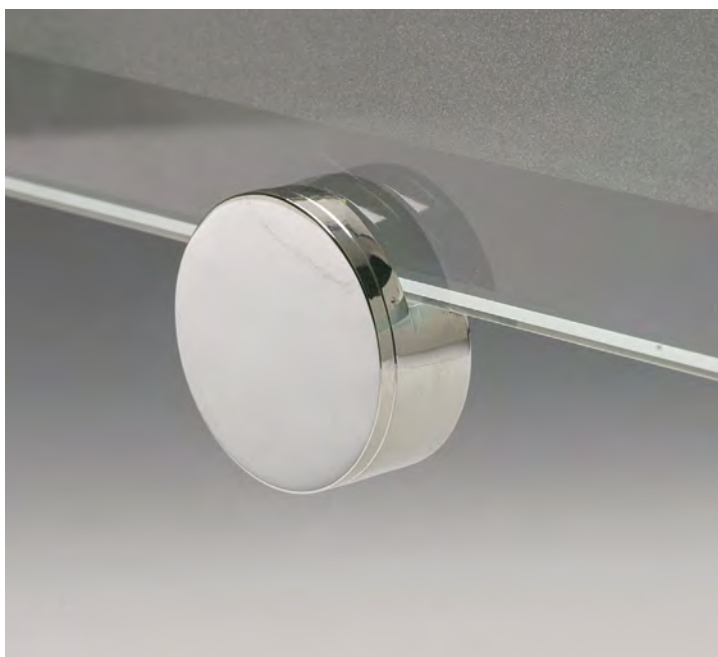

**MIRROR HOLDERS 30**

Material: Brass

Finish: /1 /2 /3

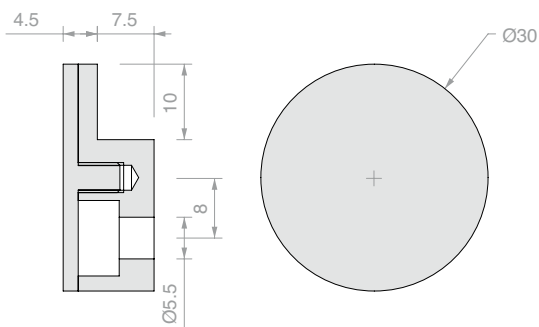

Art.	For glass	Qty
<b>MIR30</b>	From 4 to 6 mm	1 Pc



### ETOILE SERIES MIRROR HOLDER

Material: AISI 304 steel

Finish: /9

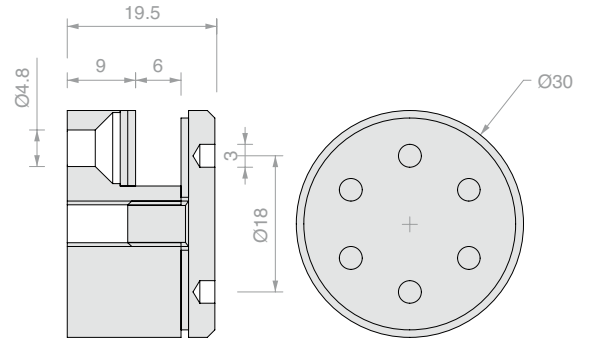

Art.	For glass	Qty
<b>FSP193</b>	6 mm	1 Pc



### PAIR OF TILTING MIRROR HOLDERS

Material: Brass

Finish: /1

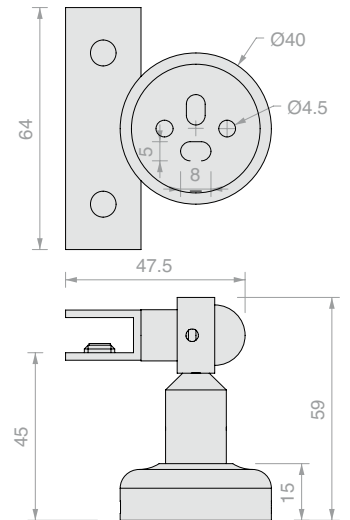

Art.	For glass	Qty
<b>MHAS01</b>	From 4 to 6 mm	1 Pc



### 4 ESCO MIRROR HOLDERS

Material: Brass

Dimensions: L 20 mm x H 28 mm interior 7 mm

Finish: /1

Art.	For glass	Distance from wall	Qty
<b>GAN001</b>	From 4 to 6 mm	6 mm	1 Pc



#### 4 VITRUM MIRROR HOLDERS

Material: Steel and PVC

Dimensions: L 25 mm x H 36 mm interior 7 mm

Finish: /6/9

Art.	For glass	Distance from wall	Qty
<b>GAN002</b>	4 mm	6 mm	1 Pc
<b>GAN003</b>	6 mm	6 mm	1 Pc



#### CORNERS FOR MIRRORS

Material: Brass

Finish: /95

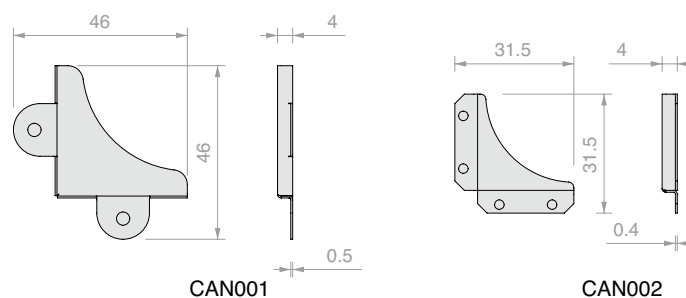

Art.	For glass	Package	Qty
<b>CAN001</b>	4 mm	100 Pcs	1 Pc
<b>CAN002</b>	4 mm	100 Pcs	1 Pc



#### ROUND CONCAVE MIRROR

2X magnification

Art.	Dimensions	Thickness	Qty
<b>SPECTOND1</b>	Ø200 mm	2 mm	1 Pc
<b>SPECTOND2</b>	Ø250 mm	2 mm	1 Pc
<b>SPECTOND3</b>	Ø300 mm	2 mm	1 Pc



ANALYTICAL  
INDEX  
VOLUME 4





Art.	Page	Art.	Page	Art.	Page	Art.	Page	Art.	Page
057.3078.002	85	BT2820	419	CANANG3	415	CHDA1500G	303	CLS68	394
3MSGP	425	BT31	419	CANANG32	415	CHDA500	303	CLS70	394
ATEC0	441	BT3322	365	CANANG33	415	CHDA500G	303	CMIRR10.2000	417
ATEC5	441	BT3325	365	CANANG34	415	CHDA55	303	CMIRR10.3000	417
BDCER81001	318	BT3520	419	CBD500	386	CHDA55G	303	CMIRR8.2000	417
BDCER81003	320	BT3525	419	CBD580	387	CHDA65	303	CMIRR8.3000	417
BDCER81005	322	CAN001	445	CER26	340	CHDA65G	303	CMIR RTP10	417
BDCER81007	324	CAN002	445	CER27	341	CHDA75	303	CMIR RTP8	417
BDCER81013	326	CANAL06	415	CER28	342	CHDA75G	303	CPM247	393
BDCER81015	328	CANAL1	415	CER29	343	CHDA83	304	CSP75	298
BDCHD6801	253	CANAL12	415	CER30	344	CHDA831	304	CSP85	298
BDCHD6803	257	CANAL13	415	CER31	345	CHDA85	304	DCC08	114
BDCHD6805	261	CANAL16	415	CER32	346	CHDA851	304	DCC10	114
BDCHD6807	265	CANAL2	415	CER33	347	CHDA86	305	DCC218	153
BDCHD6813	269	CANAL22	415	CER700	372	CHDA861	305	DCC220	153
BDCHD6815	273	CANAL23	415	CER700UV	370	CHDA88	305	DCC90	52
BDCHD81001	253	CANAL26	415	CER720	373	CHDA90	305	DCC90SQ	52
BDCHD81003	257	CANAL3	415	CER720UV	371	CHDA901	305	DCCFLAT003	127
BDCHD81005	261	CANAL32	415	CER800	380	CHDA93	305	DCCFLAT007	129
BDCHD81007	265	CANAL33	415	CER880	381	CHDM41	300	DCCFLAT009	131
BDCHD81013	269	CANAL34	415	CERZ31	382	CHDM43	300	DCCFLAT011	133
BDCHD81015	273	CANALH88	416	CERZ3180	384	CHDM45	301	DCCFT12	135
BDFIX-DX	117	CANALH90	416	CERZ33	383	CHDM47	301	DCCFT16	135
BDFIX-SX	117	CANALH92	416	CHD10	283	CHDM52	301	DCCFT18	135
BDFIX10	118	CANALM01	417	CHD10COV	282	CHDM57	300	DCCFT20	112
BDFIX2-DX	117	CANALM012	417	CHD1135	288	CHDMP1	306	DCCFT90	134
BDFIX2-SX	117	CANALM02	417	CHD12	284	CHDMP2	306	DCCFTMUR	134
BDFIX5-DX	118	CANALM022	417	CHD14	285	CHDMP3	306	DCCFTVET	134
BDFIX5-SX	118	CANALM03	417	CHD180	286	CHDMP4	306	DCCFTVW	134
BDFIX7-DX	118	CANALM032	417	CHD190	287	CHDT1000	302	DCS108	88
BDFIX7-SX	118	CANALSF48	416	CHD20	290	CHDT1000G	302	DCS110	88
BDFIX8	118	CANALSF50	416	CHD20COV	289	CHDT1500	302	DCS206	51
BDSQ6801	165	CANALSF52	416	CHD2135	297	CHDT1500G	302	DCS208	51
BDSQ6803	169	CANALSU66	416	CHD22	291	CHDT500	302	DCU108	88
BDSQ6805	173	CANALSU68	416	CHD24	292	CHDT500G	302	DCU108SCT	87
BDSQ6807	177	CANALSU70	416	CHD24P	293	CL105	299	DCU110	88
BDSQ6813	181	CANALSU72	416	CHD280	294	CLK20	392	DCU110SCT	87
BDSQ6815	185	CANANG1	415	CHD280P	295	CLKM27	392	DCU206	51
BDSQ81001	165	CANANG12	415	CHD290	296	CLM19	299	DCU206SCT	51
BDSQ81003	169	CANANG13	415	CHDA05	304	CLM25	393	DCU208	51
BDSQ81005	173	CANANG14	415	CHDA06	304	CLP23	298	DCU208SCT	51
BDSQ81007	177	CANANG2	415	CHDA08	304	CLPM29	298	DCV108	88
BDSQ81013	181	CANANG22	415	CHDA1000	303	CLS18	299	DCV110	88
BDSQ81015	185	CANANG23	415	CHDA1000G	303	CLS24	393	DQ30	203
BT28	419	CANANG24	415	CHDA1500	303	CLS245	392	DQ30COV	202





Art.	Page	Art.	Page	Art.	Page	Art.	Page	Art.	Page
DQ3135	208	DQC575	227	FOU1011.30	243	G50U50	69	GLMKIT305	150
DQ32	204	DQC58	227	FOU1013.30	243	GAN001	444	GLMKIT701	147
DQ34	205	DQC59	227	FSP193	444	GAN002	445	GLMKIT703	149
DQ37	209	DQC61	228	FX1000	425	GAN003	445	GLMRCT	151
DQ375	210	DQC63	228	FXGAB01	370	GLM3000	151	GLMSFORO	110
DQ380	206	DQC65	228	FXTNT01	425	GLM3020	153	GLMSPA06	115
DQ390	207	DQG26	90	G35KIT01	44	GLM3023	153	GLMSPA08	115
DQ40	215	DQGKT01	90	G35KIT02	44	GLM3050	151	GLMSPA10	115
DQ40COV	214	DQGKT03	90	G35KIT03	44	GLM7000	151	GLMTND10	152
DQ4135	222	DQM07	231	G35KIT04	44	GLMAN	151	GM01	427
DQ42	216	DQM09	231	G35KIT05	45	GLMBDLN15	152	GM012200	427
DQ44	217	DQM11	231	G35KIT06	45	GLMBRM	152	GM013000	427
DQ44P	218	DQM41	229	G35KIT07	45	GLMBRV	152	GM014	119
DQ475	223	DQM43	229	G35KIT08	45	GLMDCCFORO	135	GM01410	86
DQ480	219	DQM45	230	G35S10DMP	34	GLMDSTP	152	GM0141022	86
DQ480P	220	DQM47	230	G35S10STP	34	GLMDSTV	153	GM0141025	86
DQ490	221	DQM49	231	G35S20DMP	36	GLMFLAT028DX	105	GM01422	119
DQ497	224	DQM50	230	G35S20STP	36	GLMFLAT028SX	105	GM01422NR	119
DQA05	90	DQM52	229	G35S30DMP	38	GLMFLAT030	99	GM01425	119
DQA06	90	DQM54	230	G35S30STP	38	GLMFLAT032DX	106	GM01425NR	119
DQA08	90	DQM57	229	G35S40DMP	40	GLMFLAT032SX	106	GM0143000	119
DQA1000	233	DQMP2	235	G35S40STP	40	GLMFLAT034	100	GM0143000NR	119
DQA1500	233	DQMP4	235	G35U10DMP	27	GLMFLAT036	109	GM02	245
DQA500	233	DQMP6	235	G35U10STP	27	GLMFLAT038	103	GM0210	245
DQA55	233	DQMP7	235	G35U20DMP	29	GLMFLAT040DX	107	GM022500	245
DQA65	233	DQMP8	235	G35U20STP	29	GLMFLAT040SX	107	GM022500NR	245
DQA75	233	DQMP9	235	G35U30DMP	31	GLMFLAT042	101	GM02NR	245
DQA83	234	DQP2525	236	G35U30STP	31	GLMFLATMUR	110	GM04	245
DQA85	234	DQP365	237	G35U40DMP	33	GLMFLATVET	110	GM0422	245
DQA86	234	DQP375	237	G35U40STP	33	GLMFORO	152	GM0425	245
DQA8670	234	DQP385	236	G50KIT01	82	GLMFT1000	110	GM0430	245
DQA87	234	DQT1000	232	G50KIT02	82	GLMFT12	110	GM05	48
DQA88	90	DQT1500	232	G50KIT03	82	GLMFT14	111	GM0522	48
DQA89	235	DQT500	232	G50KIT04	82	GLMFT16	111	GM052500	48
DQA90	235	DQTS2525	236	G50KIT05	83	GLMFT18	111	GM0530	48
DQA93	235	DQX1000	232	G50KIT06	83	GLMFT2000	110	GM06	85
DQA99	235	DQX1500	232	G50S10	70	GLMFT26	111	GM0622	85
DQC35	212	DQX500	232	G50S20	72	GLMFT30	114	GM0622NR	85
DQC37	212	FOL1010.30	243	G50S30	74	GLMFT3000	110	GM0625	85
DQC38	212	FOL1515.30	243	G50S40	76	GLMFT37	112	GM0625NR	85
DQC39	213	FOL2020.30	243	G50S50	78	GLMFT40	114	GM063000	85
DQC395	213	FOP10.30	243	G50U10	61	GLMFT50	114	GM063000NR	85
DQC51	226	FOP15.30	243	G50U20	63	GLMFT90	112	GM0722	429
DQC53	226	FOP20.30	243	G50U30	65	GLMKIT301	146	GM0725	429
DQC55	226	FOU1009.30	243	G50U40	67	GLMKIT303	148	GM073000	429



Art.	Page	Art.	Page	Art.	Page	Art.	Page	Art.	Page
GM11DX	49	GM5030	434	GM7225	429	HAND10057VHB	139	MF06	400
GM11DX2500	49	GM50522	422	GM7230	429	HAND13040VHB	53	MF06100	396
GM11SX	49	GM50525	422	GM8020	430	HAND6640VHB	53	MF06130	396
GM11SX2500	49	GM512DX25	423	GM8025	430	LM0859.100	83	MF06160	396
GM12DX20	244	GM512SX25	423	GM880607	51	LM0859.150	83	MF09410	399
GM12DX22	244	GM5210	435	GM880615	51	LM0859.200	83	MF09410C20	399
GM12DX25	244	GM5222	435	GM900807	51	LM0859.300	83	MF09413	399
GM12SX20	244	GM5225	435	GM900815	51	LM3515.075	46	MF09413C20	399
GM12SX22	244	GM5230	435	GM921007	88	LM3515.150	46	MF09416	399
GM12SX25	244	GM5422	245	GM921015	88	LM3515.15045	46	MF09416C20	399
GM13DX2200	428	GM5430	245	GMPINZ	435	LM3515.200	46	MF09430	398
GM13DX3000	428	GM56010	422	GMPINZ02	435	LM3515.300	46	MF10	399
GM13SX2200	428	GM56020	422	GMVHB1	424	LM3538.100	46	MF1000	399
GM13SX3000	428	GM56025	422	GMVHB13000	424	LM3538.150	46	MF12	399
GM1520DX	86	GM5610	119	GMVHB13000NR	424	LM3538.200	46	MF127	350
GM1520DXNR	86	GM5620	119	GMVHB1NR	424	LM3538.300	46	MF129	350
GM1520SX	86	GM5625	119	GMVHB2	424	LM5859.100	83	MF1300	399
GM1520SXNR	86	GM5630	119	GMVHB2NR	424	LM5859.150	83	MF1515	351
GM1530DX	86	GM57022	423	GMVHB3	424	LM5859.200	83	MF1600	399
GM1530SX	86	GM57025	423	GMVHB33000	424	LM5859.300	83	MF2845	402
GM15DX	86	GM58	244	GMVHB33000NR	424	LMU20.150	406	MF2890	402
GM15SX	86	GM5830	244	GMVHB3NR	424	LMU20.300	406	MF300A	402
GM1720DX	431	GM58NR	244	GMVHB4	424	LMU20B.150	238	MF300B	402
GM1720SX	87	GM6010	244	GMVHB43000	424	LMU20B.220	238	MF300V	402
GM1730DX	431	GM6020	244	GMVHB43000NR	424	LMU20B.300	238	MF350	363
GM1730SX	87	GM6025	244	GMVHB4NR	424	LMU20TP	407	MF600A	401
GM17DX	431	GM6030	244	GOC009	52	LMU20TPB	238	MF600B	401
GM17SX	87	GM62	244	GOCCHIA8	89	LMU86B.100	238	MF600H	401
GM40	433	GM6225	244	GSLSVL	425	LMU86B.150	238	MF645A	401
GM4025	433	GM6230	244	GTUP2	49	LMU86B.300	238	MF645B	401
GM4030	433	GM6230DX	48	GTUP2G	49	LR1000	441	MF9812	398
GM42	433	GM6230SX	48	GTUP2N	49	LR1100	441	MFAC1000	395
GM4225	433	GM62DX	48	GTUP3	49	LR300	440	MFBOC	400
GM4230	433	GM62SX	48	GTUP3G	49	LR320	440	MFCC11	395
GM44	434	GM6630DX	428	GTUP3N	49	LR400	440	MFCC13	395
GM4425	434	GM6630SX	428	GTUP4	49	LR500	440	MFCC15	395
GM4430	434	GM66DX	428	GTUP4G	49	LR900	441	MFCC17	395
GM46	434	GM66SX	428	GTUP4N	49	MAN500V150	53	MFCC20	395
GM4625	434	GM702020	49	GTUP5	49	MF007100	397	MFCC28	395
GM4630	434	GM702022	49	GTUP5G	49	MF007130	397	MHAS01	444
GM4810	435	GM702030	49	GTUP5N	49	MF007160	397	MIR20	443
GM4822	435	GM7022	429	GTUP6	49	MF008670	397	MIR25	443
GM4825	435	GM7025	429	GTUP6G	49	MF02	400	MIR30	443
GM4830	435	GM7030	429	GTUP6N	49	MF04	400	MORS001	348
GM50	434	GM7222	429	HAND10052VHB	53	MF05	400	MORS002	348



Art.	Page	Art.	Page	Art.	Page	Art.	Page	Art.	Page
MORS0023	348	PBD3186	47	PROTAP1730	408	SFH801	391	UTR65	408
MORS003	348	PBD3186.100	47	PROTAP1920	408	SFH802	391	VETCIL35	307
MORS004	349	PBD3186.150	47	PROTAP1930	408	SFH803	391	W61250	442
MORS005	349	PBD86TP	47	PT105110	113	SP2255	306	W61500	442
MORS033	349	PBDTP	47	PTBH1964	368	SP2255GD	307	W61TDX	442
MORSZ001	418	PEL31	437	PTUP2261-DX	366	SP255	307	W61TSX	442
MORSZ002	418	PESQ0810.075	48	PTUP2261-SX	366	SPD01	403	W63250	442
MTD3000	438	PESQ0810.150	48	PTUP26	364	SPD03	403	W63500	442
MTS10	439	PESQ0810.300	48	PTUP30	365	SPD05	403	W63TDX	442
MTS3000	438	PESQ0810B.100	238	PTUPSQ-11	362	SPD071000	403	W63TSX	442
MTS3000KR	438	PESQ0810B.150	238	PTUPSQ-1130	362	SPD072000	403		
MTS90	439	PESQ0810B.300	238	PTUPSQ-6130	362	SPD09	403		
MU30095	402	PG03	112	PTUPSQ-61C	362	SPD092300	412		
MU30095N	402	PG05	113	PTUPSQ-61L	362	SPD112300	412		
MU30135	402	POM2525	236	PTUPSQ-66	362	SPD132300	412		
MU30135N	402	POMZ001	418	PTUPSQ-6630	362	SPD153308	412		
NV3100	240	POMZ002	418	PTUPSQ-8130	362	SPD153310	412		
NV3200	240	PQ95	113	PTUPSQ-81C	362	SPD153508	412		
NV3300	240	PROALUX1520	408	PTUPSQ-81L	362	SPD153510	412		
NV3400DX	240	PROALUX1530	408	PTUPSQ-88	362	SPE2392	52		
NV3400SX	240	PROALUX1720	408	PTUPSQ-8830	362	SPE2393	52		
NV3500	240	PROALUX1730	408	PTUPSQ2016	358	SPE2394	52		
NV3600	240	PROALUX1920	408	PTUPSQ2018	358	SPE2395	52		
OPEN01CHD	279	PROALUX1930	408	PTUPSQ2036	360	SPE2397	52		
OPEN01DQ	193	PROALUXG	408	PTUPSQ2038	360	SPECTOND1	445		
OPEN01FOR10	197	PROALUXG400	408	PTUPSQACCM	363	SPECTOND2	445		
OPEN01FOR8	197	PROFALL0820	409	PTUPSQACCV	363	SPECTOND3	445		
OPEN01LMUDQ	195	PROFALL0820KR	411	PTUPSQANG	364	STOPVAPOR0	437		
OPEN01LMUMF	337	PROFALL1020	409	PTUPSQD	364	STOPVAPOR05	437		
OPEN01MORS	335	PROFALL1020KR	411	PTUPSQGUAV	363	STOPVAPOR1	437		
OPEN01NOVI	199	PROFALL1225	409	RA9008	52	STOPVAPOR12	437		
OPEN03CHD	277	PROFALL1240	409	RA9010	52	STOPVAPOR13	437		
OPEN03DQ	189	PROFALL1425	409	S1180	376	STOPVAPOR15	437		
OPEN03LMUDQ	191	PROFALL1440	409	S150	374	STOPVAPOR17	437		
OPEN03LMUMF	333	PROTAP0820	409	S153	375	STOPVAPOR19	437		
OPEN03MORS	331	PROTAP0820KR	411	S190	377	STOPVAPOR2	437		
PBCAL10	49	PROTAP1020	409	S4500	388	STOPVAPOR3	437		
PBD3183	46	PROTAP1020KR	411	S600	378	STOPVAPOR4	437		
PBD3183.150	46	PROTAP1225	409	S603	379	TS25006	243		
PBD3183.220	46	PROTAP1240	409	SAS020	400	TS250065	243		
PBD3183KR	411	PROTAP1425	409	SCR001	394	TS25009	243		
PBD3184	47	PROTAP1440	409	SFH100	389	TS25012	243		
PBD3184.100	47	PROTAP1520	408	SFH101	389	TS250125	243		
PBD3184.150	47	PROTAP1530	408	SFH102	390	TS250155	243		
PBD3184KR	411	PROTAP1720	408	SFH103	390	TS25019	243		

## FINISHES



**/1**  
Chrome



**/2**  
Gold



**/3**  
Brushed nickel

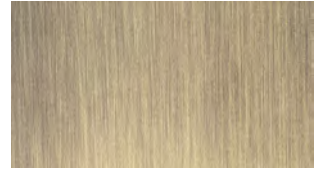

**/4**  
Bronze



**/5**  
White



**/6**  
Matt black



**/7**  
Matt chrome



**/8**  
Brushed steel



**/9**  
Machining steel (CNC)

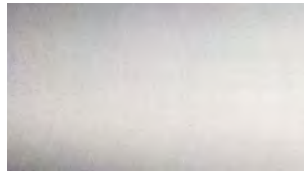

**/10**  
Raw aluminium

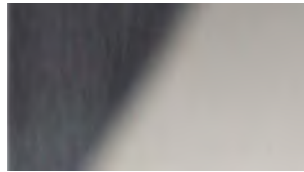

**/15**  
Polished steel



**/24**  
Brushed steel effect

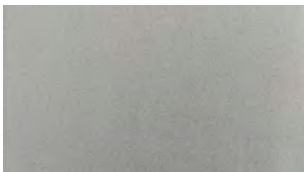

**/45**  
Matt aluminium effect



**/56**  
Grey



**/65**  
Matt black



**/66**  
Champagne aluminium

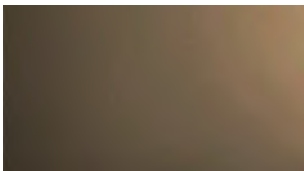

**/67**  
Dark brushed bronze aluminium

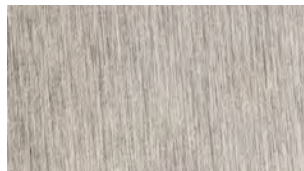

**/83**  
PVD brushed steel

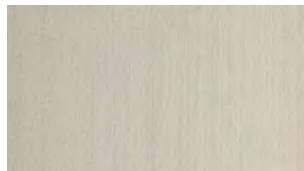

**/88**  
Brushed steel effect aluminium



**/89**  
Galvanised iron

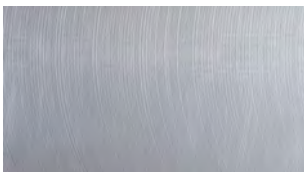

**/90**  
Machining aluminium

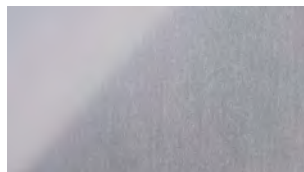

**/91**  
Polished aluminium



**/92**  
Matt nickel



**/93**  
Brass coated



**/94**  
Brushed chrome



**/95**  
Nickel-coated

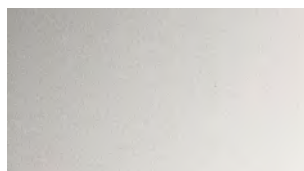

**/97**  
Matt aluminium

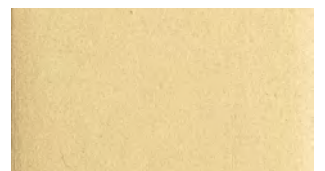

**/99**  
Brushed gold



**/R2**  
RAL9005 matt black



**/R6**  
RAL9016 matt traffic white



**/R13**  
RAL7016 matt anthracite grey



**/RAL**  
RAL9010 polished white