

Perfectly Jointing

Tiles and Natural Stone



**OTTO
CHEMIE**

Sealants • Adhesives

| | |
|--|--------------|
| Preface | 3 |
| Optimum sealing of sanitary facilities | 4-5 |
| Substrates for sealing walls and floors | 6-7 |
| Preparing the joint | 8 |
| Using OTTO primers | 9 |
| General primer table | 9 |
| The causes of mould formation | 11 |
| Preventive measures | 12 |
| Recommended OTTO products | 13-14 |
| OTTOFLEX System | 16 |
| Professional accessoires by OTTO | 17-18 |
| Exact calculation of the quantities required | 19 |
| General valid joint dimension | 19 |

Preface

4.000 years of tiles

The history of the tile begins in the East where, even in very early times around 2000 BC, people decorated their houses built from sun-dried or burnt brick with “tiled” floor coverings.

In 711, the Moors set foot in Andalusia on the European mainland and conquered large parts of Spain. Over the years, the Spaniards adopted the Moors’ techniques and laid the foundation for today’s definition of a tile. Their “azulejos” (Arabic: al zulaich = small stone) now had fixed dimensions and had fully-glazed surfaces.

The mechanical manufacture of tiles in Germany began in 1852. They were called “plates” at the time by Villery & Boch. As the surfaces of the first Villeroy & Boch floor tiles were mosaics, “Mettlach mosaic plates” or “Mettlach plates” for almost a century, as generic terms for floor tiles.

Optimum sealing of sanitary facilities

The classification of surface sealing of sanitary facilities is subject to the classification into two different stress groups, which in turn are divided into levels of humidity stress. The “general buildings authority approval (abP)” covers the high stress classes, the requirements of the “Central Association of the German Construction Trades (ZDB)” are designed for the classification of moderate stress classes.

Preparing the substrates with the OTTOFLEX system

OTTOFLEX Sealing Strip

Substrates, which are laid with OTTOFLEX Sealing Strip should generally to be checked for evenness, stability and moisture. Adhesive repelling properties must be removed from the surface. We recommend to prime absorbent substrates with OTTOFLEX Deep Primer. For smooth surfaces (e.g. glazed tiles) it is recommended to use a levelling compound with highly flexible tile adhesive for filling pores and roughness. The residual moisture of the substrates can be found in the technical data sheet.

The surface must be clean, sustainable and even.

The adhesive, which is used for bonding the OTTOFLEX Sealing Strip must be matched with the surface, exhibiting a good adhesion to the nonwoven fabric of the OTTOFLEX Sealing Strip. Basically, the use of hydraulic binding C 2 tile adhesives is possible. The OTTOFLEX Sealing Strip must be cut to the final size before application.

To achieve stress classes A or C in accordance with the abP as well as A0 in accordance with the ZDB, the sealing strip in the joint area must be bonded with at least 5 cm of overlap using OTTOCOLL® M 500.

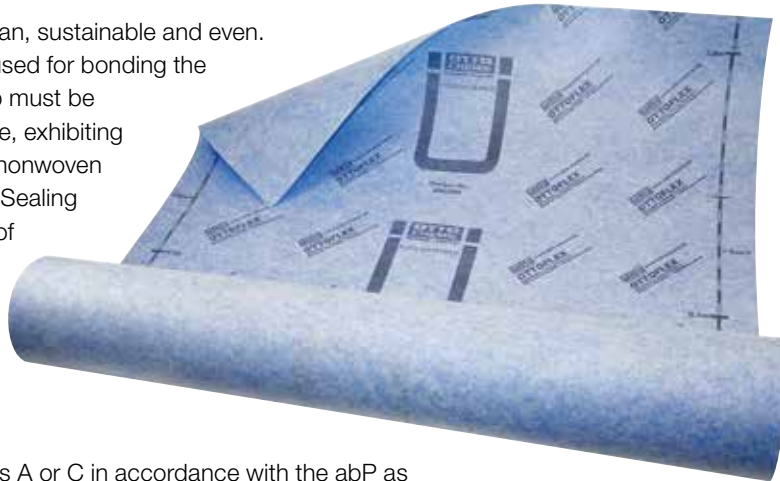

OTTOFLEX Slurry Seal Coating

The substrate must be sound, stable, absorbent and largely flat. Soiling from oil, grease or other release agents must be removed. Honeycombing and cavities as well as bumps that are larger than permitted by DIN 18202 must be evened out with a suitable concrete filler. The substrate must be well wetted before applying OTTOFLEX Slurry Seal Coating. Surface should be damp. The residual moisture must not exceed the following values:

Cement screed: 2 %

Anhydrite screed: 0,5 %

Anhydrite screed (heated): 0,3 %

To avoid clumping during mixing, please follow the instructions in the technical data sheet.

OTTOFLEX Protective Coating

The substrates must be even, clean, stable, dry, free from oil, grease and other residues such as dust, dirt and loose particles etc. Residues can be removed by brushing and suction cleaning. The surface must not have unevenness, ridges or continuous cracks. Uneven surfaces have to be adjusted with an adequate tile adhesive either before or after the application. The residual moisture must not exceed the following values:

Cement screed: 2 %

Anhydrite screed: 0,5 %

Anhydrite screed (heated): 0,3 %

Pretreat porous and highly porous mineral substrates, gypsum plaster boards and other gypsum based substrates with OTTOFLEX Primer and let dry for at least 2 hours.

For non-porous building substrates such as polyurethane, polyacrylates, epoxides etc., please contact our technical department.

For instructions on processing the sealing materials, please see the technical data sheets for the products.

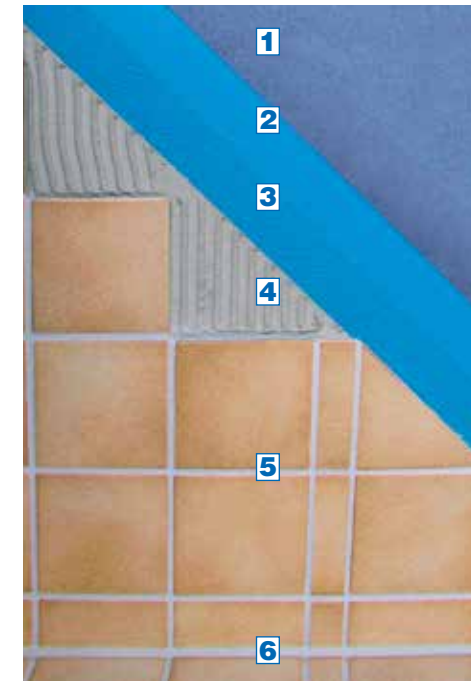

- 1 OTTOFLEX Primer
- 2 OTTOFLEX Protective Coating - 1st coat
- 3 OTTOFLEX Protective Coating - 2nd coat
- 4 Tile adhesive
- 5 Joint mortar
- 6 OTTO silicone sealant, e.g. OTTOSEAL® S 100 - the premium bathroom silicone

| Stress classes | A | A0 | B | B0 | C | | |
|---|---|--|--|--|--|----|---|
| Stress | high | moderate | high | moderate | high | | |
| Areas of application | directly and indirectly stressed ¹ wall surfaces in rooms in which utility and cleaning water is used frequently or continuously, such as in shower facilities (public or private) | directly and indirectly stressed ¹ wall surfaces in rooms in which utility and cleaning water is not used very often, such as in domestic bathrooms, hotel bathrooms | container wall surfaces subject to stress from high-pressure water, such as public and private swimming pools, both indoor and outdoor | directly and indirectly stressed ¹ outdoor wall surfaces with no water pressure stress, such as on balconies and terraces (not over rooms in use) | directly and indirectly stressed ¹ wall surfaces very often or continuously exposed to utility and cleaning water, whereby limited chemical stress on the seal occurs, such as in commercial kitchens and laundries | | |
| Substrates for moderate stress A0, B0 | Substrates for high stress A, B, C | Concrete according to DIN 1045/DIN EN 206 | DMR | DMR | MR | MR | R |
| | | Lime cement plaster of mortar group P II CS III according to DIN V 18550 and DIN EN 998-1 compression strength 3.5 to 7.5 N/mm ² | DMR | DMR | - | MR | R |
| | | Light lime cement plaster of mortar group P II CS III according to DIN V 18550 and DIN EN 998-1 compression strength at least 2.5 N/mm ² | DMR | DMR | - | MR | R |
| | | Sand-limestone flat block stones without or with only a thin coating | DMR | DMR | - | MR | R |
| | | Cement plaster of mortar group P III CS IV according to DIN V 18550 and DIN EN 998-1 compression strength at least 6.0 N/mm ² | DMR | DMR | - | MR | R |
| | | Cement plaster in swimming pools of mortar group P III CS IV according to DIN V 18550 and DIN EN 998-1 without addition of lime hydrate/lime flux, compression strength at least 6.0 N/mm ² | - | - | MR | - | - |
| | Hollow wall panels made from lightweight concrete according to DIN 18148, processed in accordance with DIN 4103 with hydraulically hardened mortars | DMR | DMR | - | - | R | |
| | Cement-bonded mineral panels | DMR | DMR | - | - | R | |
| | Composite elements of expanded or extruded polystyrene with mortar coating and fabric reinforcement | DMR | DMR | - | - | R | |
| | Porous concrete panels in accordance with DIN 4166, processed in accordance with DIN 4103 | DMR | DMR | - | - | R | |
| | Gypsum plaster of mortar group P IV1 in accordance with DIN 18550-1 and 18550-2 | - | DMR | - | - | - | |
| | Gypsum wall panels ¹ in accordance with DIN 12859 | - | DMR | - | - | - | |
| Gypsum fibre panels in accordance with DIN 15283-2, gypsum panels in accordance with DIN 18180 and/or DIN EN 520 ¹ | - | DMR | - | - | - | | |

¹ With direct and indirect stress of stress class A, moisture-sensitive substrates are not permitted for waterproofing.

Sealing compounds: D Polymer dispersions • M Plastic cement mortar combinations • R Reaction resins

With indirect stress, the following also applies:

in stress class A, moisture-sensitive substrates are not permitted for waterproofing in the case of indirect stress.

In stress class A0, moisture-sensitive substrates may also be permitted in the case of indirect stress. Sealing is not necessarily required for moisture resistant substrates of stress class A0.

| Stress classes | A | A0 | B | B0 | C | | |
|---------------------------------------|---|--|---|---|---|----|---|
| Stress | high | moderate | high | moderate | high | | |
| Areas of application | directly and indirectly stressed ¹ floor surfaces in rooms in which utility and cleaning water is used frequently or continuously, such as in swimming pool walkways and shower facilities (public or private) | directly and indirectly stressed ¹ floor surfaces in rooms in which utility and cleaning water is not used very often, such as in domestic bathrooms, hotel bathrooms, floor surfaces with drains in these areas of application | container floor surfaces subject to stress from high-pressure water, such as public and private swimming pools, both indoor and outdoor | directly and indirectly stressed ¹ outdoor floor surfaces with no water pressure stress, such as on balconies and terraces (not over rooms in use) | directly and indirectly stressed ¹ floor surfaces very often or continuously exposed to utility and cleaning water, whereby limited chemical stress on the seal occurs, such as in commercial kitchens and laundries | | |
| Substrates for moderate stress A0, B0 | Substrates for high stress A, B, C | Concrete according to DIN 1045/DIN EN 206 | MR | DMR | MR | MR | R |
| | | Cement screeds in accordance with DIN 18560 | MR | DMR | MR | MR | R |
| | | Mastic asphalt screeds in accordance with DIN 18560 | MR | DMR | - | - | R |
| | | Cement-bonded mineral panels ^{1,2} | MR | DMR | - | MR | - |
| | Composite elements of expanded or extruded polystyrene with mortar coating and fabric reinforcement ^{1,2} | MR | DMR | - | - | - | |
| | Gypsum fibre panels in accordance with DIN 15283-2, gypsum panels in accordance with DIN 18180 and/or DIN EN 520 ¹ | - | DMR | - | - | - | |
| | Calcium sulphate-bonded screeds in accordance with DIN 18560 ¹ | - | DMR | - | - | - | |

¹ without floor drain

² If floor drains are provided, elements with factory-installed floor drains and evidence of suitability from an abP must be used.

Sealing compounds: D Polymer dispersions • M Plastic cement mortar combinations • R Reaction resins

With indirect stress, the following also applies:

in stress class A, moisture-sensitive substrates are not permitted for waterproofing in the case of indirect stress.

In stress class A0, moisture-sensitive substrates may also be permitted in the case of indirect stress. Sealing is not necessarily required for moisture resistant substrates of stress class A0.

Before jointing some basic preliminary work must be carried out. It is imperative that the joint and adhesive flanks are cleaned of dust. If the joint was wet-cleaned, it must definitely be dried or you must wait for it to dry.

In the case of natural stone – and particularly **sandstone** in this instance it is of elementary importance that the joints be masked immediately after they are clean and dry. This type of stone is especially susceptible to staining caused by primers, the smoothing agents or residues from poorly applied sealant. However, it is also advisable to mask the joints well for other types of natural stone in order to obtain an optimal result.

The following pictures show the optimal preparation of a joint taking the jointing of tiles as an example.



We recommend masking **the tiles** prior to priming and grouting.

1. Preliminary cleaning of the adhesive flanks using the appropriate **OTTO Cleaner** and a soft cloth. The joint flanks must be free of dirt, dust and grease.



2. Backfilling the joint with **OTTO PE-B2 backup foam rod** in the appropriate size. The foam size must be chosen so that it requires a certain amount of pressure to insert it. Only then the joint is guaranteed to be filled out completely and the joint depth limited, too.



3. Possibly prime the adhesive flanks with the appropriate **OTTO Primer or Cleanprimer** with a soft paintbrush on absorbent substrates or with a soft cloth on non-absorbent substrates.

Applications with natural stone

OTTO Primer 1102 – The sandstone primer

Improves the adhesion of natural stone silicones OTTOSEAL® S 70 and S 117 to sandstone

OTTO Primer 1216 – improves the adhesion of S 70 / S 117 / S 140 to natural stone, artificial and concrete stone.

Applications with metal

OTTO Cleanprimer 1101 – The adhesion improver

Cleans and improves the adhesion to coated and uncoated metallic materials and various plastics (e.g. PVC sanitary acrylic)

OTTO Primer 1216 – The silicone metal primer

Improves adhesion to metallic materials (e.g. stainless steel, aluminium, anodised aluminium, copper, brass, galvanised steel and chromium) and coated metals (e.g. enamel, rustproof iron).

Also suitable for some plastics.

Applications on porous substrates

OTTO Primer 1215 – The silicone primer for absorbent substrates

Improves adhesion to mineral materials (e.g. concrete, plaster, porous concrete) and to porous substrates (e.g. plaster, fibre cement, wood). Contains toluene and therefore is subject to the prohibition of self service.

Applications in permanently wet areas

OTTO Primer 1218 – The silicone primer for continuously wet conditions

Improves adhesion in continuously wet conditions, such as the swimming pool silicone

OTTOSEAL® S 18 on mineral materials (e.g. concrete, mortar, grout)

and S 70 / S 140 on natural stone

Contains toluene and therefore is subject to the prohibition of self service.



Causes for mould attack

- Moisture paired with poor ventilation
- Heat (above +20 °C)
- Sustention for moulds, e.g. organic deposits in the form of body care products, soap residue and scurf

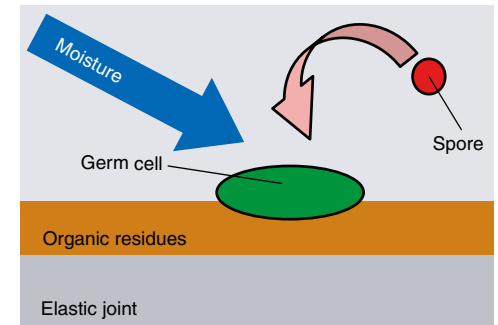

Primary attack

In the case of primary attack the mould initially grows only in the organic deposits on the surface of the sealant and can be combated with [Anti-Schimmelspray \(Anti-mould spray\)](#)

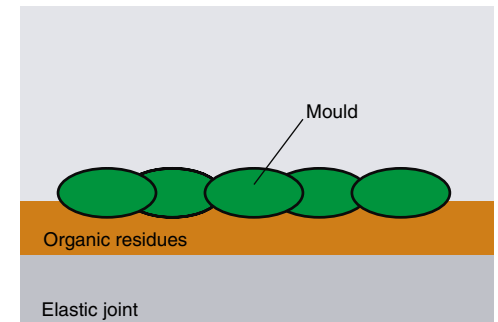

Secondary attack

In the case of secondary attack the mould grows into the sealant. In this case the sealant must first be removed by mechanical means and then completely eliminated with [OTTO SilOut \(OTTO SilOut silicone remover\)](#). Before installing new joints the areas of the joints affected should first be thoroughly cleaned and then treated with [Anti-Schimmelspray \(Anti-mould spray\)](#)

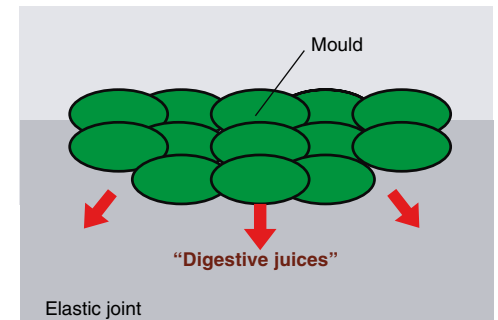

The improved protection against mildew is of particular relevance to joints that require maintenance. Despite the improved protection against mildew, however, these should still be regularly inspected and replaced if necessary.

The benefits of **OTTO Fungitect® Silver Technology**:

- Silver has been a well-known antimicrobial agent for centuries and is now used in a number of ways in ointments and creams for healing wounds as well as in eye drops
- Silver is harmless to health and environmentally benign
- It is well known that microorganisms are unable to build up any resistance to silver, which means they are unable to “accustom” themselves to the active agent, so it remains effective
- In contrast to conventional fungicides, **OTTO Fungitect® Silver Technology** will not wash out of the sealing material, even with heavy water loads, and is therefore effective for longer
- The intervals for maintaining and replacing the elastic joints can be extended considerably



OTTOSEAL® S 130

The alkoxy bathroom silicone with ecologically harmless Fungitect® Silver Technology

Neutral-curing 1-component silicone sealant based on alkoxy



OTTOSEAL® S 140

The hotel and spa silicone with double protection against mould

Neutral-curing 1-component silicone sealant, MEKO-free



OTTOCOLL® M 500



The water-resistant premium hybrid adhesive/sealant

1-component adhesive and sealant based on silane-terminated polymers (hybrid)



OTTOCOLL® M 501



The transparent premium hybrid-adhesive

1-component adhesive based on silane-terminated polymers (hybrid)



OTTOCOLL® S 16

The mirror adhesive

Neutral-curing 1-component silicone adhesive based on alkoxy



OTTOSEAL® S 18

The swimming pool silicone

Neutral-curing 1-component silicone sealant



OTTOSEAL® S 27

The silicone for food and drinking water

1-component acetate-curing silicone sealant

**OTTOSEAL® S 70**

★★★★★
PREMIUM

**The premium natural stone silicone**

Neutral-curing 1-component silicone sealant, MEKO-free

**OTTOSEAL® S 100**

★★★★★
PREMIUM

**The premium bathroom silicone**

1-component acetate-curing silicone sealant

**OTTOSEAL® S 120**

★★★★★
PREMIUM

**The premium alkoxy window silicone**

Neutral-curing 1-component silicone sealant based on alkoxy

**OTTOSEAL® S 121**

★★★★★
PREMIUM

**The low odour premium bathroom silicone**

Neutral-curing 1-component silicone sealant based on alkoxy

**OTTO SilOut****The silicone remover**

Thixotropic paste for removing of cured silicone sealants and adhesives

**OTTO StainEx****The marble and natural stone degreasing paste**

Ready-to-use paste

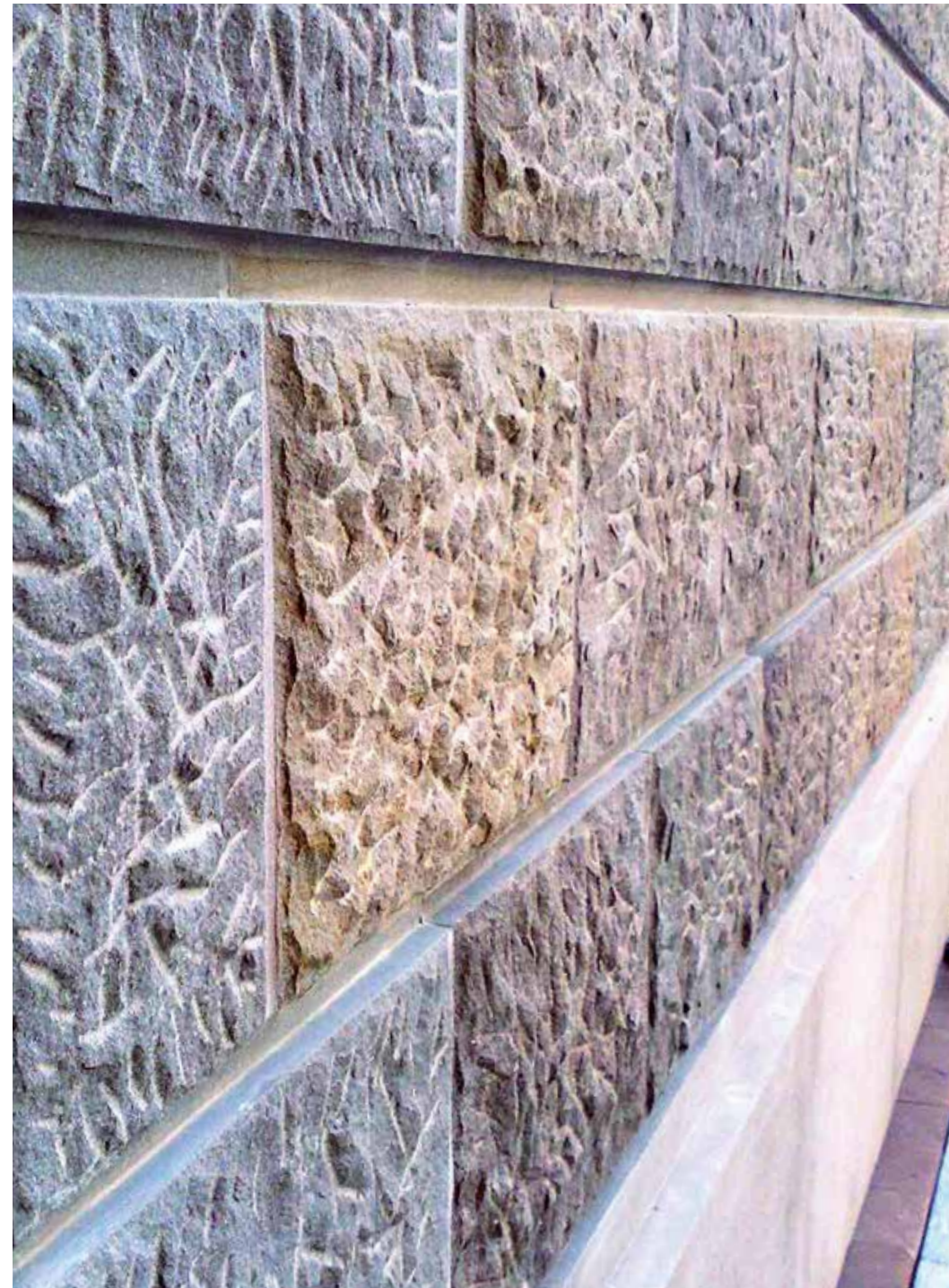

OTTOFLEX System

Waterproofing system under ceramic and natural stone coverings, for interior and exterior use



OTTOCORD PE-B2

The closed-cell PE back-up foam rod
Extruded backfilling material made of polyethylene (PE)



OTTO Cleaner C

The profile-cleaner
Cleaning of substrate before adhesion



OTTO Primer 1216

The primer for natural stone and metal
Primer to improve the adhesion on natural stone, metallic materials and some plastics



OTTO Fugenboy

Highly flexible smoothing tool for professionals



OTTO Smoothing Agent

Aqueous solution of surface-active substances



OTTO Marble Silicone Smoothing Agent

Aqueous solution of surface-active substances





OTTO Hand-operated Gun H40

Hand-operated gun for rigorous continuous use. For 290/300/310 ml cartridges. With smoothing driving rod. Professional quality



OTTO Hand-operated Gun H37

Heavy duty hand-operated gun made of highly impact-resistant plastic, very lightweight. With closer for sliding sleeve, smooth driving rod and sliding sleeve for 290/300/310 ml cartridges.



OTTO Hand-operated Gun H400 (Cab)

Hand-operated gun, economy model. Aluminium cylinders, for foil bags up to 400 ml. For 290/300/310 ml cartridges. Ladder hook available separately. No spare part service



OTTO Hand-operated Gun H245

Hand-operated gun with a press capacity of 5 kN for the application of highly viscous materials. For 280/290/300/310 ml cartridges. With smooth driving rod.



OTTO Compressed Air Gun P400 KB

Compressed air gun with optimum centre of gravity. Anodised aluminium tube for cartridges and up to 400 ml aluminium foil bag



OTTO Compressed Air Gun P2x310

Compressed air gun for the use of twin cartridges 2 x 310 ml

(10.8 Volt Li-Ion)



OTTO Accumulator Gun Type HPS-4T

For cartridges and alu-foilbags up to 400 ml (with transport case, quick charger with charge indicator) 10.8 volt (charging time 30 minutes), 2 Li-Ion batteries (10.8 volt/1.5 Ah). Weight of gun with battery: approx. 2.2 kg



Metres per 300/310 ml cartridge

| | | Joint width [mm] | | | | | | |
|------------------|----|------------------|---|----|-----|-----|-----|-----|
| | | 5 | 7 | 10 | 12 | 15 | 20 | 25 |
| Joint depth [mm] | 5 | 12 | 8 | 6 | | | | |
| | 7 | | 6 | 4 | 3 | | | |
| | 10 | | | 3 | 2,5 | 2,0 | 1,5 | |
| | 12 | | | | 2,1 | 1,7 | 1,2 | 1,0 |
| | 15 | | | | | 1,3 | 1,0 | 0,8 |

Metres per 400 ml aluminium foil bag

| | | Joint width [mm] | | | | | | |
|------------------|----|------------------|----|----|-----|-----|-----|-----|
| | | 5 | 7 | 10 | 12 | 15 | 20 | 25 |
| Joint depth [mm] | 5 | 15 | 10 | 8 | | | | |
| | 7 | | 8 | 5 | 4 | | | |
| | 10 | | | 4 | 3 | 2,6 | 2,0 | |
| | 12 | | | | 2,7 | 2,2 | 1,6 | 1,3 |
| | 15 | | | | | 1,7 | 1,3 | 1,0 |

Metres per 580 ml aluminium foil bag

| | | Joint width [mm] | | | | | | |
|------------------|----|------------------|----|----|----|-----|-----|-----|
| | | 5 | 7 | 10 | 12 | 15 | 20 | 25 |
| Joint depth [mm] | 5 | 23 | 15 | 11 | | | | |
| | 7 | | 11 | 7 | 6 | | | |
| | 10 | | | 6 | 5 | 4 | 3 | |
| | 12 | | | | 4 | 3 | 2,4 | 2,0 |
| | 15 | | | | | 2,5 | 1,9 | 1,4 |

Note: This values are approximate and serve as a rough guide for rightangled joints. The depth of the joints is measured to the rear of the profile.

General valid joint dimension

| Joint width b in ration of joint depth t [mm] | | | | | |
|---|-------|-------|-------|-------|-------|
| b | 10-15 | 15-20 | 20-25 | 25-30 | 30-35 |
| t | 8±2 | 10±2 | 12±2 | 15±3 | 15±3 |

Source: Industrieverband Dichtstoffe e.V./ HS PR. Additional information to the IVD's information leaflets under www.ivd-ev.de

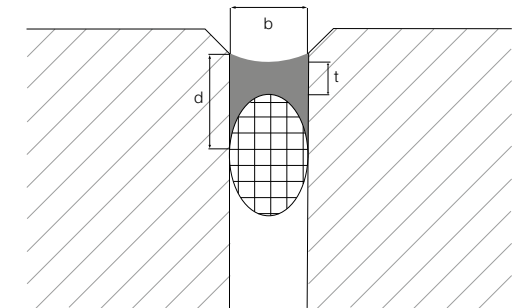

The rule of thumb for calculating the joint dimension is as follows:

Sealant depth (t) = 0,5 x joint width (b).

The thickness of the sealant (d) equals 2/3 of the joint width (b).

OTTO Head office

Tel.: 0049-8684-908-540

Fax: 0049-8684-908-549

E-mail: info@otto-chemie.com

From UK: 0800-783 60 53

OTTO Technical Service

Tel.: 0049-8684-908-460

Fax: 0049-8684-908-469

E-mail: tae@otto-chemie.de

OTTO Order processing

Tel.: 0049-8684-908-310

Fax: 0049-8684-908-319

E-mail: mab@otto-chemie.de

Your specialised dealer:

In order to ensure a quick and correct handling of your orders we would like to ask you to send them by fax or e-mail. Thank you in advance for your cooperation.

Notes:

The information in the present document corresponds to the status quo on going to print, refer to the index. With a new edition this edition becomes invalid. Due to the many possible influences during and after application, the customer always has to carry out trials first. Please observe the respective technical data sheet! This information is available on the Internet at www.otto-chemie.com. Errors and typographical errors are excepted.

For further information please contact:



Sealants • Adhesives

Hermann Otto GmbH · Krankenhausstr. 14 · 83413 Fridolfing, GERMANY

Tel.: 0049-8684-908-0 · Fax: 0049-8684-1260

E-mail: info@otto-chemie.de · Internet: www.otto-chemie.com